Sun Microsystems

JSR 318: Enterprise JavaBeansTM, Version 3.1

EJB Core Contracts and Requirements

EJB 3.1 Expert Group

Specification Lead:

Kenneth Saks, Sun Microsystems

Please send comments to: jsr-318-comments@jcp.org

Specification : : JSR-000318 Enterprise JavaBeans(tm) ("Specification")

Version: 3.1

Status: Final Release

Release: 10 December 2009

Copyright 2009 SUN MICROSYSTEMS, INC.
4150 Network Circle, Santa Clara, California 95054, U.S.A
All rights reserved.

LIMITED LICENSE GRANTS

1. License for Evaluation Purposes. Sun hereby grants you a fully-paid, non-exclusive, non-transferable, worldwide, limited license (without the right to sublicense), under Sun's applicable intellectual property rights to view, download, use and reproduce the Specification only for the purpose of internal evaluation. This includes (i) developing applications intended to run on an implementation of the Specification, provided that such applications do not themselves implement any portion(s) of the Specification, and (ii) discussing the Specification with any third party; and (iii) excerpting brief portions of the Specification in oral or written communications which discuss the Specification provided that such excerpts do not in the aggregate constitute a significant portion of the Specification.

2. License for the Distribution of Compliant Implementations. Sun also grants you a perpetual, non-exclusive, non-transferable, worldwide, fully paid-up, royalty free, limited license (without the right to sublicense) under any applicable copyrights or, subject to the provisions of subsection 4 below, patent rights it may have covering the Specification to create and/or distribute an Independent Implementation of the Specification that: (a) fully implements the Specification including all its required interfaces and functionality; (b) does not modify, subset, superset or otherwise extend the Licensor Name Space, or include any public or protected packages, classes, Java interfaces, fields or methods within the Licensor Name Space other than those required/authorized by the Specification or Specifications being implemented; and (c) passes the Technology Compatibility Kit (including satisfying the requirements of the applicable TCK Users Guide) for such Specification ("Compliant Implementation"). In addition, the foregoing license is expressly conditioned on your not acting outside its scope. No license is granted hereunder for any other purpose (including, for example, modifying the Specification, other than to the extent of your fair use rights, or distributing the Specification to third parties). Also, no right, title, or interest in or to any trademarks, service marks, or trade names of Sun or Sun's licensors is granted hereunder. Java, and Java-related logos, marks and names

are trademarks or registered trademarks of Sun Microsystems, Inc. in the U.S. and other countries.

3. Pass-through Conditions. You need not include limitations (a)-(c) from the previous paragraph or any other particular "pass through" requirements in any license You grant concerning the use of your Independent Implementation or products derived from it. However, except with respect to Independent Implementations (and products derived from them) that satisfy limitations (a)-(c) from the previous paragraph, You may neither: (a) grant or otherwise pass through to your licensees any licenses under Sun's applicable intellectual property rights; nor (b) authorize your licensees to make any claims concerning their implementation's compliance with the Specification in question.

4. Reciprocity Concerning Patent Licenses.

a. With respect to any patent claims covered by the license granted under subparagraph 2 above that would be infringed by all technically feasible implementations of the Specification, such license is conditioned upon your offering on fair, reasonable and non-discriminatory terms, to any party seeking it from You, a perpetual, non-exclusive, non-transferable, worldwide license under Your patent rights which are or would be infringed by all technically feasible implementations of the Specification to develop, distribute and use a Compliant Implementation.

b With respect to any patent claims owned by Sun and covered by the license granted under subparagraph 2, whether or not their infringement can be avoided in a technically feasible manner when implementing the Specification, such license shall terminate with respect to such claims if You initiate a claim against Sun that it has, in the course of performing its responsibilities as the Specification Lead, induced any other entity to infringe Your patent rights.

c Also with respect to any patent claims owned by Sun and covered by the license granted under subparagraph 2 above, where the infringement of such claims can be avoided in a technically feasible manner when implementing the Specification such license, with respect to such claims, shall terminate if You initiate a claim against Sun that its making, having made, using, offering to sell, selling or importing a Compliant Implementation infringes Your patent rights.

5. Definitions. For the purposes of this Agreement: "Independent Implementation" shall mean an implementation of the Specification that neither derives from any of Sun's source code or binary code materials nor, except with an appropriate and separate license from Sun, includes any of Sun's source code or binary code materials; "Licensor Name Space" shall mean the public class or interface declarations whose names begin with "java", "javax", "com.sun" or their equivalents in any subsequent naming convention

adopted by Sun through the Java Community Process, or any recognized successors or replacements thereof; and "Technology Compatibility Kit" or "TCK" shall mean the test suite and accompanying TCK User's Guide provided by Sun which corresponds to the Specification and that was available either (i) from Sun 120 days before the first release of Your Independent Implementation that allows its use for commercial purposes, or (ii) more recently than 120 days from such release but against which You elect to test Your implementation of the Specification.

This Agreement will terminate immediately without notice from Sun if you breach the Agreement or act outside the scope of the licenses granted above.

DISCLAIMER OF WARRANTIES

THE SPECIFICATION IS PROVIDED "AS IS". SUN MAKES NO REPRESENTATIONS OR WARRANTIES, EITHER EXPRESS OR IMPLIED, INCLUDING BUT NOT LIMITED TO, WARRANTIES OF MERCHANTABILITY, FITNESS FOR A PARTICULAR PURPOSE, NON-INFRINGEMENT (INCLUDING AS A CONSEQUENCE OF ANY PRACTICE OR IMPLEMENTATION OF THE SPECIFICATION), OR THAT THE CONTENTS OF THE SPECIFICATION ARE SUITABLE FOR ANY PURPOSE. This document does not represent any commitment to release or implement any portion of the Specification in any product. In addition, the Specification could include technical inaccuracies or typographical errors.

LIMITATION OF LIABILITY

TO THE EXTENT NOT PROHIBITED BY LAW, IN NO EVENT WILL SUN OR ITS LICENSORS BE LIABLE FOR ANY DAMAGES, INCLUDING WITHOUT LIMITATION, LOST REVENUE, PROFITS OR DATA, OR FOR SPECIAL, INDIRECT, CONSEQUENTIAL, INCIDENTAL OR PUNITIVE DAMAGES, HOWEVER CAUSED AND REGARDLESS OF THE THEORY OF LIABILITY, ARISING OUT OF OR RELATED IN ANY WAY TO YOUR HAVING, IMPLEMENTING OR OTHERWISE USING USING _THE SPECIFICATION, EVEN IF SUN AND/OR ITS LICENSORS HAVE BEEN ADVISED OF THE POSSIBILITY OF SUCH DAMAGES.

You will indemnify, hold harmless, and defend Sun and its licensors from any claims arising or resulting from: (i) your use of the Specification; (ii) the use or distribution of your Java application, applet and/or implementation; and/or (iii) any claims that later versions or releases of any Specification furnished to you are incompatible with the Specification provided to you under this license.

RESTRICTED RIGHTS LEGEND

U.S. Government: If this Specification is being acquired by or on behalf of the U.S. Gov-

ernment or by a U.S. Government prime contractor or subcontractor (at any tier), then the Government's rights in the Software and accompanying documentation shall be only as set forth in this license; this is in accordance with 48 C.F.R. 227.7201 through 227.7202-4 (for Department of Defense (DoD) acquisitions) and with 48 C.F.R. 2.101 and 12.212 (for non-DoD acquisitions).

REPORT

If you provide Sun with any comments or suggestions concerning the Specification ("Feedback"), you hereby: (i) agree that such Feedback is provided on a non-proprietary and non-confidential basis, and (ii) grant Sun a perpetual, non-exclusive, worldwide, fully paid-up, irrevocable license, with the right to sublicense through multiple levels of sublicensees, to incorporate, disclose, and use without limitation the Feedback for any purpose.

GENERAL TERMS

Any action related to this Agreement will be governed by California law and controlling U.S. federal law. The U.N. Convention for the International Sale of Goods and the choice of law rules of any jurisdiction will not apply.

The Specification is subject to U.S. export control laws and may be subject to export or import regulations in other countries. Licensee agrees to comply strictly with all such laws and regulations and acknowledges that it has the responsibility to obtain such licenses to export, re-export or import as may be required after delivery to Licensee.

This Agreement is the parties' entire agreement relating to its subject matter. It supersedes all prior or contemporaneous oral or written communications, proposals, conditions, representations and warranties and prevails over any conflicting or additional terms of any quote, order, acknowledgment, or other communication between the parties relating to its subject matter during the term of this Agreement. No modification to this Agreement will be binding, unless in writing and signed by an authorized representative of each party.

Rev. April, 2006

Table of Contents

Chapter 1	Introduction.....	29
	1.1 Target Audience.....	29
	1.2 What is New in EJB 3.1	29
	1.2.1 What Was New in EJB 3.0.....	30
	1.3 Acknowledgements	31
	1.4 Organization of the Specification Documents.....	31
	1.5 Document Conventions	31
Chapter 2	Overview.....	33
	2.1 Overall Goals.....	33
	2.2 EJB Roles	34
	2.2.1 Enterprise Bean Provider	35
	2.2.2 Application Assembler.....	35
	2.2.3 Deployer.....	35
	2.2.4 EJB Server Provider.....	36
	2.2.5 EJB Container Provider	36
	2.2.6 Persistence Provider	37
	2.2.7 System Administrator	37
	2.3 Enterprise Beans.....	38
	2.3.1 Characteristics of Enterprise Beans	38
	2.3.2 Flexible Model	38
	2.4 Session, Entity, and Message-Driven Objects.....	39
	2.4.1 Session Objects	39
	2.4.2 Message-Driven Objects.....	40
	2.4.3 Entity Objects.....	40
	2.5 Standard Mapping to CORBA Protocols	40
	2.6 Mapping to Web Service Protocols	41
	2.7 Pruning the EJB API	41
	2.8 Relationship to Managed Bean Specification.....	42
Chapter 3	Client View of a Session Bean.....	43
	3.1 Overview	43
	3.2 Local, Remote, and Web Service Client Views.....	45
	3.2.1 Remote Clients.....	45
	3.2.2 Local Clients	45
	3.2.3 Choosing Between a Local or Remote Client View	46
	3.2.4 Web Service Clients	47
	3.3 EJB Container.....	48
	3.4 Client View of Session Beans Written to the EJB 3.x Simplified API	48
	3.4.1 Obtaining a Session Bean's Business Interface	48
	3.4.2 Obtaining a Reference to the No-interface View	49
	3.4.3 Session Bean's Business Interface	49

3.4.4	Session Bean's No-Interface View	50
3.4.5	Client View of Session Object's Life Cycle	51
3.4.6	Example of Obtaining and Using a Session Object	51
3.4.7	Session Object Identity	53
3.4.7.1	Stateful Session Beans	53
3.4.7.2	Stateless Session Beans	53
3.4.7.3	Singleton Session Beans	54
3.4.8	Asynchronous Invocations	54
3.4.8.1	Return Values	55
3.4.9	Concurrent Access to Session Bean References	56
3.5	The Web Service Client View of a Session Bean	56
3.5.1	JAX-WS Web Service Clients	57
3.5.2	JAX-RPC Web Service Clients	58
3.6	Remote and Local Client View of Session Beans Written to the EJB 2.1 Client View API	59
3.6.1	Locating a Session Bean's Home Interface	59
3.6.2	Session Bean's Remote Home Interface	60
3.6.2.1	Creating a Session Object	60
3.6.2.2	Removing a Session Object	61
3.6.3	Session Bean's Local Home Interface	61
3.6.3.1	Creating a Session Object	62
3.6.3.2	Removing a Session Object	62
3.6.4	EJBObject and EJBLocalObject	62
3.6.5	Object Identity	63
3.6.6	Client view of Session Object's Life Cycle	64
3.6.6.1	References to Session Object Remote Interfaces	64
3.6.6.2	References to Session Object Local Interfaces	65
3.6.7	Creating and Using a Session Object	65
3.6.8	Object Identity	67
3.6.8.1	Stateful Session Beans	67
3.6.8.2	Stateless Session Beans	67
3.6.8.3	getPrimaryKey()	68
3.6.9	Type Narrowing	68
Chapter 4	Session Bean Component Contract	69
4.1	Overview	69
4.2	Conversational State of a Stateful Session Bean	70
4.2.1	Instance Passivation and Conversational State	71
4.2.2	The Effect of Transaction Rollback on Conversational State	73
4.3	Protocol Between a Session Bean Instance and its Container	74
4.3.1	Required Session Bean Metadata	74
4.3.2	Dependency Injection	74
4.3.3	The SessionContext Interface	74
4.3.4	Session Bean Lifecycle Callback Interceptor Methods	76
4.3.5	The Optional SessionBean Interface	77
4.3.6	Use of the MessageContext Interface by Session Beans	78
4.3.7	The Optional Session Synchronization Notifications for Stateful Session Beans	78

4.3.8	Timeout Callbacks for Stateless and Singleton Session Beans.....	79
4.3.9	Business Method Delegation	79
4.3.10	Session Bean Creation	79
4.3.10.1	Stateful Session Beans	80
4.3.10.2	Stateless Session Beans	80
4.3.11	Stateful Session Bean Removal	80
4.3.12	Stateful Session Bean Timeout	81
4.3.13	Business Method Interceptor Methods for Session Beans.....	81
4.3.14	Serializing Session Bean Methods.....	82
4.3.14.1	Stateful Session Bean Concurrent Access Timeouts	82
4.3.15	Transaction Context of Session Bean Methods	83
4.4	Global JNDI Access	83
4.4.1	Syntax.....	83
4.4.1.1	java:app.....	84
4.4.1.2	java:module	85
4.4.2	Examples.....	85
4.4.2.1	Session bean exposing a single local business interface ...	85
4.4.2.2	Session bean exposing multiple client views	86
4.5	Asynchronous Methods.....	87
4.5.1	Metadata.....	87
4.5.2	Method Requirements.....	87
4.5.2.1	Business Interfaces	87
4.5.2.2	Bean Classes	87
4.5.3	Transactions	88
4.5.4	Security	88
4.5.5	Client Exception Behavior.....	88
4.6	Stateful Session Bean State Diagram	89
4.6.1	Operations Allowed in the Methods of a Stateful Session Bean Class	92
4.6.2	Dealing with Exceptions	96
4.6.3	Missed PreDestroy Calls.....	97
4.6.4	Restrictions for Transactions.....	97
4.7	Stateless Session Beans	98
4.7.1	Stateless Session Bean State Diagram	99
4.7.2	Operations Allowed in the Methods of a Stateless Session Bean Class	101
4.7.3	Dealing with Exceptions	105
4.8	Singleton Session Beans.....	106
4.8.1	Singleton Initialization.....	107
4.8.2	Singleton Destruction.....	109
4.8.3	Transaction Semantics of Initialization and Destruction	109
4.8.4	Singleton Error Handling.....	109
4.8.5	Singleton Concurrency.....	109
4.8.5.1	Container Managed Concurrency	110
4.8.5.2	Bean Managed Concurrency	111
4.8.5.3	Specification of a Concurrency Management Type.....	111
4.8.5.4	Specification of the Container Managed Concurrency Metadata for a Bean's Methods	112
4.8.5.5	Specification of Concurrency Locking Attributes with Metadata Annotations	113
4.8.6	Operations Allowed in the Methods of a Singleton Session Bean ...	115

4.9	The Responsibilities of the Bean Provider	119
4.9.1	Classes and Interfaces	120
4.9.2	Session Bean Class	120
4.9.2.1	Session Bean Superclasses	121
4.9.3	Lifecycle Callback Interceptor Methods	122
4.9.4	Session Synchronization Methods	122
4.9.5	ejbCreate<METHOD> Methods	123
4.9.6	Business Methods	123
4.9.7	Session Bean's Business Interface	124
4.9.8	Session Bean's No-Interface View	125
4.9.9	Session Bean's Remote Interface	126
4.9.10	Session Bean's Remote Home Interface	126
4.9.11	Session Bean's Local Interface	127
4.9.12	Session Bean's Local Home Interface	127
4.9.13	Session Bean's Web Service Endpoint Interface	128
4.10	The Responsibilities of the Container Provider	129
4.10.1	Generation of Implementation Classes	129
4.10.2	Generation of WSDL	130
4.10.3	Session Business Interface Implementation Class	130
4.10.4	No-Interface View Reference Class	130
4.10.5	Session EJBHome Class	131
4.10.6	Session EJBObject Class	131
4.10.7	Session EJBLocalHome Class	131
4.10.8	Session EJBLocalObject Class	131
4.10.9	Web Service Endpoint Implementation Class	132
4.10.10	Asynchronous Client Future<V> Return Value Implementation Class	132
4.10.11	Handle Classes	132
4.10.12	EJBMetaData Class	132
4.10.13	Non-reentrant Instances	132
4.10.14	Transaction Scoping, Security, Exceptions	132
4.10.15	JAX-WS and JAX-RPC Message Handlers for Web Service Endpoints	132
4.10.16	SessionContext	133
Chapter 5	Message-Driven Bean Component Contract	135
5.1	Overview	135
5.2	Goals	136
5.3	Client View of a Message-Driven Bean	136
5.4	Protocol Between a Message-Driven Bean Instance and its Container	138
5.4.1	Required MessageDrivenBean Metadata	138
5.4.2	The Required Message Listener Interface	138
5.4.3	Dependency Injection	139
5.4.4	The MessageDrivenContext Interface	139
5.4.5	Message-Driven Bean Lifecycle Callback Interceptor Methods	140
5.4.6	The Optional MessageDrivenBean Interface	140
5.4.7	Timeout Callbacks	141
5.4.8	Message-Driven Bean Creation	141
5.4.9	Message Listener Interceptor Methods for Message-Driven Beans	142
5.4.10	Serializing Message-Driven Bean Methods	142

5.4.11	Concurrency of Message Processing	142
5.4.12	Transaction Context of Message-Driven Bean Methods	142
5.4.13	Security Context of Message-Driven Bean Methods.....	143
5.4.14	Activation Configuration Properties	143
5.4.15	Message Acknowledgment for JMS Message-Driven Beans	143
5.4.16	Message Selectors for JMS Message-Driven Beans.....	144
5.4.17	Association of a Message-Driven Bean with a Destination or Endpoint	144
5.4.17.1	JMS Message-Driven Beans.....	144
5.4.18	Dealing with Exceptions	145
5.4.19	Missed PreDestroy Callbacks	146
5.4.20	Replying to a JMS Message.....	146
5.5	Message-Driven Bean State Diagram	146
5.5.1	Operations Allowed in the Methods of a Message-Driven Bean Class	148
5.6	The Responsibilities of the Bean Provider	150
5.6.1	Classes and Interfaces	150
5.6.2	Message-Driven Bean Class	150
5.6.3	Message-Driven Bean Superclasses.....	151
5.6.4	Message Listener Method	151
5.6.5	Lifecycle Callback Interceptor Methods.....	152
5.7	The Responsibilities of the Container Provider.....	152
5.7.1	Generation of Implementation Classes	152
5.7.2	Deployment of JMS Message-Driven Beans	152
5.7.3	Request/Response Messaging Types	153
5.7.4	Non-reentrant Instances	153
5.7.5	Transaction Scoping, Security, Exceptions	153
Chapter 6	Persistence	155
Chapter 7	Client View of an EJB 2.1 Entity Bean	157
7.1	Overview	157
7.2	Remote Clients	158
7.3	Local Clients.....	159
7.4	EJB Container.....	159
7.4.1	Locating an Entity Bean's Home Interface	160
7.4.2	What a Container Provides	160
7.5	Entity Bean's Remote Home Interface	161
7.5.1	Create Methods	162
7.5.2	Finder Methods	163
7.5.3	Remove Methods	164
7.5.4	Home Methods.....	164
7.6	Entity Bean's Local Home Interface	165
7.6.1	Create Methods	165
7.6.2	Finder Methods	166
7.6.3	Remove Methods	166
7.6.4	Home Methods.....	167
7.7	Entity Object's Life Cycle.....	167

	7.7.1	References to Entity Object Remote Interfaces	169
	7.7.2	References to Entity Object Local Interfaces.....	169
	7.8	Primary Key and Object Identity	170
	7.9	Entity Bean's Remote Interface	171
	7.10	Entity Bean's Local Interface	172
	7.11	Entity Bean's Handle	173
	7.12	Entity Home Handles.....	174
	7.13	Type Narrowing of Object References	174
Chapter 8	EJB 2.1	Entity Bean Component Contract for Container-Managed Persistence	175
	8.1	Overview	176
	8.2	Container-Managed Entity Persistence and Data Independence	176
	8.3	The Entity Bean Provider's View of Container-Managed Persistence.....	178
	8.3.1	The Entity Bean Provider's Programming Contract	179
	8.3.2	The Entity Bean Provider's View of Persistent Relationships	181
	8.3.3	Dependent Value Classes	181
	8.3.4	Remove Protocols	182
	8.3.4.1	Remove Methods	182
	8.3.4.2	Cascade-delete	183
	8.3.5	Identity of Entity Objects	183
	8.3.6	Semantics of Assignment for Relationships.....	184
	8.3.6.1	Use of the java.util.Collection API to Update Relationships.....	184
	8.3.6.2	Use of Set Accessor Methods to Update Relationships.....	186
	8.3.7	Assignment Rules for Relationships	187
	8.3.7.1	One-to-one Bidirectional Relationships.....	188
	8.3.7.2	One-to-one Unidirectional Relationships	189
	8.3.7.3	One-to-many Bidirectional Relationships	190
	8.3.7.4	One-to-many Unidirectional Relationships	194
	8.3.7.5	Many-to-one Unidirectional Relationships.....	197
	8.3.7.6	Many-to-many Bidirectional Relationships.....	199
	8.3.7.7	Many-to-many Unidirectional Relationships.....	203
	8.3.8	Collections Managed by the Container	206
	8.3.9	Non-persistent State	206
	8.3.10	The Relationship Between the Internal View and the Client View ...	207
	8.3.10.1	Restrictions on Remote Interfaces	207
	8.3.11	Mapping Data to a Persistent Store	207
	8.3.12	Example.....	208
	8.3.13	The Bean Provider's View of the Deployment Descriptor.....	211
	8.4	The Entity Bean Component Contract.....	215
	8.4.1	Runtime Execution Model of Entity Beans.....	215
	8.4.2	Container Responsibilities.....	217
	8.4.2.1	Container-Managed Fields.....	217
	8.4.2.2	Container-Managed Relationships.....	217
	8.5	Instance Life Cycle Contract Between the Bean and the Container.....	218
	8.5.1	Instance Life Cycle.....	219
	8.5.2	Bean Provider's Entity Bean Instance's View.....	221
	8.5.3	Container's View	225

8.5.4	Read-only Entity Beans	229
8.5.5	The EntityContext Interface.....	230
8.5.6	Operations Allowed in the Methods of the Entity Bean Class	231
8.5.7	Finder Methods	233
8.5.7.1	Single-Object Finder Methods.....	234
8.5.7.2	Multi-Object Finder Methods.....	234
8.5.8	Select Methods.....	235
8.5.8.1	Single-Object Select Methods	236
8.5.8.2	Multi-Object Select Methods.....	236
8.5.9	Timer Notifications	237
8.5.10	Standard Application Exceptions for Entities.....	237
8.5.10.1	CreateException.....	237
8.5.10.2	DuplicateKeyException.....	238
8.5.10.3	FinderException.....	238
8.5.10.4	ObjectNotFoundException	238
8.5.10.5	RemoveException.....	239
8.5.11	Commit Options.....	239
8.5.12	Concurrent Access from Multiple Transactions	241
8.5.13	Non-reentrant and Re-entrant Instances.....	242
8.6	Responsibilities of the Enterprise Bean Provider	243
8.6.1	Classes and Interfaces	243
8.6.2	Enterprise Bean Class	243
8.6.3	Dependent Value Classes	244
8.6.4	ejbCreate<METHOD> Methods.....	244
8.6.5	ejbPostCreate<METHOD> Methods.....	245
8.6.6	ejbHome<METHOD> Methods	246
8.6.7	ejbSelect<METHOD> Methods	246
8.6.8	Business Methods	246
8.6.9	Entity Bean's Remote Interface	247
8.6.10	Entity Bean's Remote Home Interface.....	247
8.6.11	Entity Bean's Local Interface.....	248
8.6.12	Entity Bean's Local Home Interface	249
8.6.13	Entity Bean's Primary Key Class.....	250
8.6.14	Entity Bean's Deployment Descriptor	250
8.7	The Responsibilities of the Container Provider.....	250
8.7.1	Generation of Implementation Classes	251
8.7.2	Enterprise Bean Class	251
8.7.3	ejbFind<METHOD> Methods.....	252
8.7.4	ejbSelect<METHOD> Methods	252
8.7.5	Entity EJBHome Class.....	253
8.7.6	Entity EJBObject Class.....	253
8.7.7	Entity EJBLocalHome Class.....	253
8.7.8	Entity EJBLocalObject Class.....	254
8.7.9	Handle Class	254
8.7.10	Home Handle Class.....	254
8.7.11	Metadata Class	255
8.7.12	Instance's Re-entrance	255
8.7.13	Transaction Scoping, Security, Exceptions	255
8.7.14	Implementation of Object References.....	255

8.7.15	EntityContext	255
8.8	Primary Keys	256
8.8.1	Primary Key That Maps to a Single Field in the Entity Bean Class ..	256
8.8.2	Primary Key That Maps to Multiple Fields in the Entity Bean Class	256
8.8.3	Special Case: Unknown Primary Key Class	256
Chapter 9	EJB QL: EJB 2.1 Query Language for Container-Managed Persistence Query Methods	259
9.1	Overview	260
9.2	EJB QL Definition	260
9.2.1	Abstract Schema Types and Query Domains	261
9.2.2	Query Methods	262
9.2.3	Naming	262
9.2.4	Examples	263
9.2.5	The FROM Clause and Navigational Declarations	264
9.2.5.1	Identifiers	265
9.2.5.2	Identification Variables	265
9.2.5.3	Range Variable Declarations	266
9.2.5.4	Collection Member Declarations	267
9.2.5.5	Example	267
9.2.5.6	Path Expressions	267
9.2.6	WHERE Clause and Conditional Expressions	268
9.2.6.1	Literals	269
9.2.6.2	Identification Variables	269
9.2.6.3	Path Expressions	269
9.2.6.4	Input Parameters	270
9.2.6.5	Conditional Expression Composition	270
9.2.6.6	Operators and Operator Precedence	270
9.2.6.7	Between <i>Expressions</i>	271
9.2.6.8	In Expressions	271
9.2.6.9	Like <i>Expressions</i>	272
9.2.6.10	Null Comparison Expressions	272
9.2.6.11	Empty Collection Comparison Expressions	273
9.2.6.12	Collection Member Expressions	273
9.2.6.13	Functional Expressions	274
9.2.7	SELECT Clause	275
9.2.7.1	Null Values in the Query Result	275
9.2.7.2	Aggregate Functions in the SELECT Clause	276
9.2.7.3	Examples	276
9.2.8	ORDER BY Clause	277
9.2.9	Return Value Types	278
9.2.10	Null Values	280
9.2.11	Equality and Comparison Semantics	281
9.2.12	Restrictions	281
9.3	Examples	281
9.3.1	Simple Queries	282
9.3.2	Queries with Relationships	282
9.3.3	Queries Using Input Parameters	283
9.3.4	Queries for Select Methods	283

	9.3.5 EJB QL and SQL	284
	9.4 EJB QL BNF	285
Chapter 10	EJB 2.1 Entity Bean Component Contract for Bean-Managed Persistence	289
	10.1 Overview of Bean-Managed Entity Persistence.....	290
	10.1.1 Entity Bean Provider's View of Persistence	290
	10.1.2 Runtime Execution Model	291
	10.1.3 Instance Life Cycle	293
	10.1.4 The Entity Bean Component Contract	295
	10.1.4.1 Entity Bean Instance's View	295
	10.1.4.2 Container's View	299
	10.1.5 Read-only Entity Beans	302
	10.1.6 The EntityContext Interface.....	302
	10.1.7 Operations Allowed in the Methods of the Entity Bean Class	303
	10.1.8 Caching of Entity State and the ejbLoad and ejbStore Methods	306
	10.1.8.1 ejbLoad and ejbStore with the NotSupported Transaction Attribute 307	
	10.1.9 Finder Method Return Type	308
	10.1.9.1 Single-Object Finder.....	308
	10.1.9.2 Multi-Object Finders	308
	10.1.10 Timer Notifications	310
	10.1.11 Standard Application Exceptions for Entities	310
	10.1.11.1 CreateException.....	310
	10.1.11.2 DuplicateKeyException.....	311
	10.1.11.3 FinderException.....	311
	10.1.11.4 ObjectNotFoundException	311
	10.1.11.5 RemoveException.....	312
	10.1.12 Commit Options.....	312
	10.1.13 Concurrent Access from Multiple Transactions	313
	10.1.14 Non-reentrant and Re-entrant Instances.....	315
	10.2 Responsibilities of the Enterprise Bean Provider	316
	10.2.1 Classes and Interfaces	316
	10.2.2 Enterprise Bean Class	316
	10.2.3 ejbCreate<METHOD> Methods.....	317
	10.2.4 ejbPostCreate<METHOD> Methods.....	318
	10.2.5 ejbFind Methods	318
	10.2.6 ejbHome<METHOD> Methods	319
	10.2.7 Business Methods	319
	10.2.8 Entity Bean's Remote Interface	320
	10.2.9 Entity Bean's Remote Home Interface.....	321
	10.2.10 Entity Bean's Local Interface.....	322
	10.2.11 Entity Bean's Local Home Interface	322
	10.2.12 Entity Bean's Primary Key Class.....	323
	10.3 The Responsibilities of the Container Provider.....	324
	10.3.1 Generation of Implementation Classes	324
	10.3.2 Entity EJBHome Class.....	325
	10.3.3 Entity EJBObject Class.....	325
	10.3.4 Entity EJBLocalHome Class.....	325

	10.3.5	Entity EJBLocalObject Class	326
	10.3.6	Handle Class	326
	10.3.7	Home Handle Class	326
	10.3.8	Metadata Class	327
	10.3.9	Instance's Re-entrance	327
	10.3.10	Transaction Scoping, Security, Exceptions	327
	10.3.11	Implementation of Object References	327
	10.3.12	EntityContext	327
Chapter 11	EJB 1.1	Entity Bean Component Contract for Container-Managed Persistence	329
	11.1	EJB 1.1 Entity Beans with Container-Managed Persistence	329
	11.1.1	Container-Managed Fields	330
	11.1.2	ejbCreate, ejbPostCreate	331
	11.1.3	ejbRemove	332
	11.1.4	ejbLoad	332
	11.1.5	ejbStore	332
	11.1.6	Finder Methods	333
	11.1.7	Home Methods	333
	11.1.8	Create Methods	333
	11.1.9	Primary Key Type	333
	11.1.9.1	Primary Key that Maps to a Single Field in the Entity Bean Class 333	
	11.1.9.2	Primary Key that Maps to Multiple Fields in the Entity Bean Class 334	
	11.1.9.3	Special Case: Unknown Primary Key Class	334
Chapter 12		Interceptors	335
	12.1	Overview	335
	12.2	Interceptor Life Cycle	336
	12.3	Business Method Interceptors	336
	12.3.1	Exceptions	336
	12.4	Timer Timeout Method Interceptors	337
	12.4.1	Exceptions	337
	12.5	Interceptors for LifeCycle Event Callbacks	337
	12.5.1	Exceptions	337
	12.6	InvocationContext	338
	12.7	Specification of Interceptors in the Deployment Descriptor	338
Chapter 13		Support for Transactions	339
	13.1	Overview	339
	13.1.1	Transactions	339
	13.1.2	Transaction Model	340
	13.1.3	Relationship to JTA and JTS	341
	13.2	Sample Scenarios	341
	13.2.1	Update of Multiple Databases	341
	13.2.2	Messages Sent or Received Over JMS Sessions and Update of Multiple	

	Databases	342
13.2.3	Update of Databases via Multiple EJB Servers	344
13.2.4	Client-Managed Demarcation	345
13.2.5	Container-Managed Demarcation	346
13.3	Bean Provider's Responsibilities	347
13.3.1	Bean-Managed Versus Container-Managed Transaction Demarcation	347
13.3.1.1	Non-Transactional Execution	347
13.3.2	Isolation Levels	348
13.3.3	Enterprise Beans Using Bean-Managed Transaction Demarcation ..	348
13.3.3.1	getRollbackOnly and setRollbackOnly Methods	353
13.3.4	Enterprise Beans Using Container-Managed Transaction Demarcation	354
13.3.4.1	javax.ejb.SessionSynchronization Interface	355
13.3.4.2	javax.ejb.EJBContext.setRollbackOnly Method	356
13.3.4.3	javax.ejb.EJBContext.getRollbackOnly method	356
13.3.5	Use of JMS APIs in Transactions	356
13.3.6	Specification of a Bean's Transaction Management Type	356
13.3.7	Specification of the Transaction Attributes for a Bean's Methods ...	357
13.3.7.1	Specification of Transaction Attributes with Metadata Annotations	360
13.3.7.2	Specification of Transaction Attributes in the Deployment Descriptor	361
13.4	Application Assembler's Responsibilities	364
13.5	Deployer's Responsibilities	364
13.6	Container Provider Responsibilities	364
13.6.1	Bean-Managed Transaction Demarcation	365
13.6.2	Container-Managed Transaction Demarcation for Session and Entity Beans	368
13.6.2.1	NOT_SUPPORTED	368
13.6.2.2	REQUIRED	368
13.6.2.3	SUPPORTS	369
13.6.2.4	REQUIRES_NEW	369
13.6.2.5	MANDATORY	369
13.6.2.6	NEVER	370
13.6.2.7	Transaction Attribute Summary	370
13.6.2.8	Handling of setRollbackOnly Method	371
13.6.2.9	Handling of getRollbackOnly Method	371
13.6.2.10	Handling of getUserTransaction Method	372
13.6.2.11	Session Synchronization Callbacks	372
13.6.2.12	Timing of Return Value Marshalling w.r.t. Transaction Boundaries	372
13.6.3	Container-Managed Transaction Demarcation for Message-Driven Beans	372
13.6.3.1	NOT_SUPPORTED	373
13.6.3.2	REQUIRED	373
13.6.3.3	Handling of setRollbackOnly Method	373
13.6.3.4	Handling of getRollbackOnly Method	374
13.6.3.5	Handling of getUserTransaction Method	374
13.6.4	Local Transaction Optimization	374
13.6.5	Handling of Methods that Run with "an unspecified transaction context"	374
13.7	Access from Multiple Clients in the Same Transaction Context	375

	13.7.1	Transaction “Diamond” Scenario with an Entity Object	376
	13.7.2	Container Provider’s Responsibilities	377
	13.7.3	Bean Provider’s Responsibilities	377
	13.7.4	Application Assembler and Deployer’s Responsibilities.....	377
	13.7.5	Transaction Diamonds involving Session Objects.....	377
Chapter 14		Exception Handling.....	379
	14.1	Overview and Concepts.....	379
	14.1.1	Application Exceptions	379
	14.1.2	Goals for Exception Handling.....	380
	14.2	Bean Provider’s Responsibilities	380
	14.2.1	Application Exceptions	380
	14.2.2	System Exceptions	382
	14.2.2.1	javax.ejb.NoSuchEntityException	383
	14.3	Container Provider Responsibilities	384
	14.3.1	Exceptions from a Session Bean’s Business Interface Methods and No-Interface View Methods384	
	14.3.2	Exceptions from Method Invoked via Session or Entity Bean’s 2.1 Client View or through Web Service Client View387	
	14.3.3	Exceptions from PostConstruct and PreDestroy Methods of a Session Bean 391	
	14.3.4	Exceptions from Message-Driven Bean Message Listener Methods 391	
	14.3.5	Exceptions from PostConstruct and PreDestroy Methods of a Message-Driven Bean393	
	14.3.6	Exceptions from an Enterprise Bean’s Timeout Callback Method ... 393	
	14.3.7	Exceptions from Other Container-invoked Callbacks	394
	14.3.8	javax.ejb.NoSuchEntityException	395
	14.3.9	Non-existing Stateful Session or Entity Object.....	396
	14.3.10	Exceptions from the Management of Container-Managed Transactions396	
	14.3.11	Release of Resources.....	396
	14.3.12	Support for Deprecated Use of java.rmi.RemoteException.....	397
	14.4	Client’s View of Exceptions	397
	14.4.1	Application Exception.....	398
	14.4.1.1	Local and Remote Clients.....	398
	14.4.1.2	Web Service Clients.....	398
	14.4.2	java.rmi.RemoteException and javax.ejb.EJBException.....	398
	14.4.2.1	javax.ejb.EJBTransactionRolledbackException, javax.ejb.TransactionRolledbackLocalException, and javax.transaction.TransactionRolledbackException399	
	14.4.2.2	javax.ejb.EJBTransactionRequiredException, javax.ejb.TransactionRequiredLocalException, and javax.transaction.TransactionRequiredException400	
	14.4.2.3	javax.ejb.NoSuchEJBException, javax.ejb.NoSuchObjectLocalException, and java.rmi.NoSuchObjectException400	
	14.5	System Administrator’s Responsibilities.....	400
Chapter 15		Support for Distributed Interoperability	401
	15.1	Support for Distribution.....	401

15.1.1	Client-Side Objects in a Distributed Environment	402
15.2	Interoperability Overview	402
15.2.1	Interoperability Goals	403
15.3	Interoperability Scenarios.....	404
15.3.1	Interactions Between Web Containers and EJB Containers for E-Commerce Applications404	
15.3.2	Interactions Between Application Client Containers and EJB Containers Within an Enterprise's Intranet405	
15.3.3	Interactions Between Two EJB Containers in an Enterprise's Intranet406	
15.3.4	Intranet Application Interactions Between Web Containers and EJB Containers407	
15.4	Overview of Interoperability Requirements.....	407
15.5	Remote Invocation Interoperability.....	408
15.5.1	Mapping Java Remote Interfaces to IDL	409
15.5.2	Mapping Value Objects to IDL	409
15.5.3	Mapping of System Exceptions	409
15.5.4	Obtaining Stub and Client View Classes	410
15.5.5	System Value Classes.....	410
15.5.5.1	HandleDelegate SPI.....	411
15.6	Transaction Interoperability	412
15.6.1	Transaction Interoperability Requirements.....	412
15.6.1.1	Transaction Context Wire Format	412
15.6.1.2	Two-Phase Commit Protocol.....	412
15.6.1.3	Transactional Policies of Enterprise Bean References	414
15.6.1.4	Exception Handling Behavior	414
15.6.2	Interoperating with Containers that do not Implement Transaction Interoperability414	
15.6.2.1	Client Container Requirements	415
15.6.2.2	EJB container requirements.....	415
15.7	Naming Interoperability	417
15.8	Security Interoperability.....	418
15.8.1	Introduction	418
15.8.1.1	Trust Relationships Between Containers, Principal Propagation419	
15.8.1.2	Application Client Authentication.....	420
15.8.2	Securing EJB Invocations	420
15.8.2.1	Secure Transport Protocol	421
15.8.2.2	Security Information in IORs	422
15.8.2.3	Propagating Principals and Authentication Data in IIOP Messages 422	
15.8.2.4	Security Configuration for Containers	424
15.8.2.5	Runtime Behavior.....	424
Chapter 16	Enterprise Bean Environment.....	427
16.1	Overview	427
16.2	Enterprise Bean's Environment as a JNDI Naming Context.....	429
16.2.1	Sharing of Environment Entries.....	429
16.2.2	Annotations for Environment Entries	430
16.2.3	Annotations and Deployment Descriptors	432

16.3	Responsibilities by EJB Role	432
16.3.1	Bean Provider's Responsibilities	433
16.3.2	Application Assembler's Responsibility	433
16.3.3	Deployer's Responsibility	433
16.3.4	Container Provider Responsibility	433
16.4	Simple Environment Entries.....	434
16.4.1	Bean Provider's Responsibilities	434
16.4.1.1	Injection of Simple Environment Entries Using Annotations	434
16.4.1.2	Programming Interfaces for Accessing Simple Environment Entries	435
16.4.1.3	Declaration of Simple Environment Entries in the Deployment Descriptor	436
16.4.2	Application Assembler's Responsibility	440
16.4.3	Deployer's Responsibility	440
16.4.4	Container Provider Responsibility	440
16.5	EJB References.....	441
16.5.1	Bean Provider's Responsibilities	441
16.5.1.1	Injection of EJB References	441
16.5.1.2	EJB Reference Programming Interfaces.....	442
16.5.1.3	Declaration of EJB References in Deployment Descriptor	443
16.5.2	Application Assembler's Responsibilities	445
16.5.2.1	Overriding Rules.....	448
16.5.3	Deployer's Responsibility	448
16.5.4	Container Provider's Responsibility	449
16.6	Web Service References	450
16.7	Resource Manager Connection Factory References.....	450
16.7.1	Bean Provider's Responsibilities	450
16.7.1.1	Injection of Resource Manager Connection Factory References	451
16.7.1.2	Programming Interfaces for Resource Manager Connection Factory References	451
16.7.1.3	Declaration of Resource Manager Connection Factory References in Deployment Descriptor	453
16.7.1.4	Standard Resource Manager Connection Factory Types ...	455
16.7.2	Deployer's Responsibility	455
16.7.3	Container Provider Responsibility	456
16.7.4	System Administrator's Responsibility.....	457
16.8	Resource Environment References.....	457
16.8.1	Bean Provider's Responsibilities	457
16.8.1.1	Injection of Resource Environment References	458
16.8.1.2	Resource Environment Reference Programming Interfaces	458
16.8.1.3	Declaration of Resource Environment References in Deployment Descriptor	458
16.8.2	Deployer's Responsibility	459
16.8.3	Container Provider's Responsibility	459
16.9	Message Destination References	459
16.9.1	Bean Provider's Responsibilities	459
16.9.1.1	Injection of Message Destination References.....	459
16.9.1.2	Message Destination Reference Programming Interfaces ..	460
16.9.1.3	Declaration of Message Destination References in Deployment	

	Descriptor461	
16.9.2	Application Assembler's Responsibilities	462
16.9.3	Deployer's Responsibility	465
16.9.4	Container Provider's Responsibility	465
16.10	Persistence Unit References	466
16.10.1	Bean Provider's Responsibilities	466
16.10.1.1	Injection of Persistence Unit References	466
16.10.1.2	Programming Interfaces for Persistence Unit References ..	466
16.10.1.3	Declaration of Persistence Unit References in Deployment Descrip- tor467	
16.10.2	Application Assembler's Responsibilities	468
16.10.2.1	Overriding Rules.....	469
16.10.3	Deployer's Responsibility	469
16.10.4	Container Provider Responsibility	470
16.10.5	System Administrator's Responsibility	470
16.11	Persistence Context References.....	470
16.11.1	Bean Provider's Responsibilities	471
16.11.1.1	Injection of Persistence Context References	471
16.11.1.2	Programming Interfaces for Persistence Context References471	
16.11.1.3	Declaration of Persistence Context References in Deployment Descriptor472	
16.11.2	Application Assembler's Responsibilities	474
16.11.2.1	Overriding Rules.....	474
16.11.3	Deployer's Responsibility	475
16.11.4	Container Provider Responsibility	475
16.11.5	System Administrator's Responsibility	475
16.12	UserTransaction Interface.....	476
16.12.1	Bean Provider's Responsibility	477
16.12.2	Container Provider's Responsibility	477
16.13	ORB References	477
16.13.1	Bean Provider's Responsibility	478
16.13.2	Container Provider's Responsibility	478
16.14	TimerService References.....	478
16.14.1	Bean Provider's Responsibility	479
16.14.2	Container Provider's Responsibility	479
16.15	EJBContext References	479
16.15.1	Bean Provider's Responsibility	479
16.15.2	Container Provider's Responsibility	479
16.16	Deprecated EJBContext.getEnvironment Method	480
Chapter 17	Security Management	483
17.1	Overview	483
17.2	Bean Provider's Responsibilities.....	485
17.2.1	Invocation of Other Enterprise Beans	485
17.2.2	Resource Access	485
17.2.3	Access of Underlying OS Resources	486
17.2.4	Programming Style Recommendations.....	486
17.2.5	Programmatic Access to Caller's Security Context	486

	17.2.5.1	Use of <code>getCallerPrincipal</code>	487
	17.2.5.2	Use of <code>isCallerInRole</code>	489
	17.2.5.3	Declaration of Security Roles Referenced from the Bean's Code 489	
17.3		Responsibilities of the Bean Provider and/or Application Assembler	491
	17.3.1	Security Roles	492
	17.3.2	Method Permissions	494
	17.3.2.1	Specification of Method Permissions with Metadata Annotations 494	
	17.3.2.2	Specification of Method Permissions in the Deployment Descriptor 495	
	17.3.2.3	Unspecified Method Permissions	499
	17.3.3	Linking Security Role References to Security Roles	499
	17.3.4	Specification of Security Identities in the Deployment Descriptor... 500	
	17.3.4.1	Run-as	500
17.4		Deployer's Responsibilities	501
	17.4.1	Security Domain and Principal Realm Assignment	501
	17.4.2	Assignment of Security Roles	502
	17.4.3	Principal Delegation	502
	17.4.4	Security Management of Resource Access	502
	17.4.5	General Notes on Deployment Descriptor Processing.....	503
17.5		EJB Client Responsibilities	503
17.6		EJB Container Provider's Responsibilities.....	503
	17.6.1	Deployment Tools	503
	17.6.2	Security Domain(s)	504
	17.6.3	Security Mechanisms	504
	17.6.4	Passing Principals on EJB Calls.....	504
	17.6.5	Security Methods in <code>javax.ejb.EJBContext</code>	505
	17.6.6	Secure Access to Resource Managers.....	505
	17.6.7	Principal Mapping.....	505
	17.6.8	System Principal.....	505
	17.6.9	Runtime Security Enforcement	506
	17.6.10	Audit Trail	507
17.7		System Administrator's Responsibilities.....	507
	17.7.1	Security Domain Administration	507
	17.7.2	Principal Mapping.....	507
	17.7.3	Audit Trail Review	507
Chapter 18		Timer Service	509
	18.1	Overview	509
	18.2	Bean Provider's View of the Timer Service	510
	18.2.1	Calendar-Based Time Expressions.....	511
	18.2.1.1	Attribute Syntax	512
	18.2.1.2	Expression Rules.....	514
	18.2.1.3	Examples.....	514
	18.2.2	Automatic Timer Creation.....	516
	18.2.3	Non-persistent Timers	517
	18.2.4	The Timer Service Interface.....	518

	18.2.4.1 Example	519
	18.2.5 Timeout Callbacks	519
	18.2.5.1 Timeout Callbacks for Programmatic Timers.....	520
	18.2.5.2 Timeout Callbacks for Automatically Created Timers.....	520
	18.2.5.3 Timeout Callback Method Requirements	520
	18.2.6 The Timer and TimerHandle Interfaces	521
	18.2.7 Timer Identity.....	522
	18.2.8 Transactions	522
18.3	Bean Provider's Responsibilities.....	523
	18.3.1 Enterprise Bean Class	523
	18.3.2 TimerHandle	523
18.4	Container's Responsibilities	523
	18.4.1 TimerService, Timer, and TimerHandle Interfaces.....	523
	18.4.2 Automatic Timers.....	524
	18.4.3 Timer Expiration and Timeout Callback Method	524
	18.4.4 Timer Cancellation.....	524
	18.4.5 Entity Bean Removal	525
Chapter 19	Deployment Descriptor.....	527
	19.1 Overview	527
	19.2 Bean Provider's Responsibilities.....	528
	19.3 Application Assembler's Responsibility	532
	19.4 Container Provider's Responsibilities	534
	19.5 Deployment Descriptor XML Schema.....	535
Chapter 20	Packaging.....	587
	20.1 Overview	587
	20.2 Deployment Descriptor	588
	20.3 Packaging Requirements	588
	20.4 Enterprise Beans Packaged in a .war.....	589
	20.4.1 Class Loading.....	589
	20.4.2 Component Environment	589
	20.4.3 Visibility of the Local Client View	590
	20.4.4 Ejb-names.....	590
	20.4.5 EJB 2.1/1.1 Entity Bean Restriction	590
	20.4.6 JAX-RPC Endpoint Restriction	590
	20.4.7 Example	590
	20.5 Deployment Descriptor and Annotation Processing	591
	20.5.1 Ejb-jar Deployment Descriptor and Annotation Processing.....	591
	20.5.2 .war Deployment Descriptor and Annotation Processing.....	591
	20.6 The Client View and the ejb-client JAR File.....	592
	20.7 Requirements for Clients.....	593
	20.8 Example.....	593

Chapter 21	Runtime Environment	595
	21.1 EJB 3.1 Lite	596
	21.2 Bean Provider's Responsibilities	597
	21.2.1 APIs Provided by Container	598
	21.2.2 Programming Restrictions	598
	21.3 Container Provider's Responsibility	600
	21.3.1 EJB 3.1 Requirements	601
	21.3.2 JNDI Requirements	601
	21.3.3 JTA 1.1 Requirements	602
	21.3.4 JDBC™ 3.0 Extension Requirements	602
	21.3.5 JMS 1.1 Requirements	603
	21.3.6 Argument Passing Semantics	603
	21.3.7 Other Requirements	604
	21.4 Compatibility and Migration	604
	21.4.1 Support for Existing Applications	604
	21.4.2 Default Stateful Session Bean Concurrency Behavior	604
	21.4.3 Default Application Exception Subclassing Behavior	604
	21.4.4 Interoperability of EJB 3.1 and Earlier Components	604
	21.4.4.1 Clients written to the EJB 2.x APIs	604
	21.4.4.2 Clients written to the EJB 3.x API	605
	21.4.4.3 Combined use of EJB 2.x and EJB 3.x persistence APIs ...	605
	21.4.5 Adapting EJB 3.x Session Beans to Earlier Client Views	605
	21.4.5.1 Stateless Session Beans	606
	21.4.5.2 Stateful Session Beans	606
Chapter 22	Embeddable Usage	607
	22.1 Overview	607
	22.2 Bootstrapping API	608
	22.2.1 EJBContainer	608
	22.2.2 Standard Initialization Properties	609
	22.2.2.1 javax.ejb.embeddable.provider	609
	22.2.2.2 javax.ejb.embeddable.modules	609
	22.2.2.3 javax.ejb.embeddable.appName	610
	22.2.3 Looking Up Session Bean References	610
	22.2.4 Embeddable Container Shutdown	610
	22.3 Container Provider's Responsibilities	611
	22.3.1 Runtime Environment	611
	22.3.2 Naming Lookups	611
	22.3.3 Embeddable Container Bootstrapping	611
	22.3.4 Concrete javax.ejb.EJBContainer Implementation Class	612
Chapter 23	Responsibilities of EJB Roles	613
	23.1 Bean Provider's Responsibilities	613
	23.1.1 API Requirements	613
	23.1.2 Packaging Requirements	613
	23.2 Application Assembler's Responsibilities	614

	23.3	EJB Container Provider's Responsibilities	614
	23.4	Persistence Provider's Responsibilities	614
	23.5	Deployer's Responsibilities.....	614
	23.6	System Administrator's Responsibilities	614
	23.7	Client Programmer's Responsibilities	615
Chapter 24		Related Documents	617
Appendix A		Revision History	619
	A.1	Early Draft	619
	A.2	Public Draft	620
	A.3	Proposed Final Draft.....	622
	A.4	Final Release	624

List of Figures

Figure 1	Session Bean Example Objects	52
Figure 2	Web Service Client View of Stateless Session Beans Deployed in a Container	57
Figure 3	Life Cycle of a Session Object	64
Figure 4	Session Bean Example Objects	66
Figure 5	Life Cycle of a Stateful Session Bean Instance	89
Figure 6	Life Cycle of a Stateless Session Bean	100
Figure 7	Life Cycle of a Singleton Session Bean	106
Figure 8	Client view of Message-Driven Beans Deployed in a Container	137
Figure 9	Life Cycle of a Message-Driven Bean	147
Figure 10	Client View of Entity Beans Deployed in a Container	161
Figure 11	Client View of Entity Object Life Cycle	168
Figure 12	View of Underlying Data Sources Accessed Through Entity Bean	178
Figure 13	Relationship Example	208
Figure 14	Overview of the Entity Bean Runtime Execution Model	216
Figure 15	Life Cycle of an Entity Bean Instance	219
Figure 16	Multiple Clients Can Access the Same Entity Object Using Multiple Instances	241
Figure 17	Multiple Clients Can Access the Same Entity Object Using Single Instance	242
Figure 18	Several Entity Beans with Abstract Persistence Schemas Defined in the Same Ejb-jar File	263
Figure 19	Client View of Underlying Data Sources Accessed Through Entity Bean	290
Figure 20	Overview of the Entity Bean Runtime Execution Model	292
Figure 21	Life Cycle of an Entity Bean Instance	293
Figure 22	Multiple Clients Can Access the Same Entity Object Using Multiple Instances	314
Figure 23	Multiple Clients Can Access the Same Entity Object Using Single Instance	315
Figure 24	Updates to Simultaneous Databases	342
Figure 25	Message Sent to JMS Queue and Updates to Multiple Databases	343
Figure 26	Message Sent to JMS Queue Serviced by Message-Driven Bean and Updates to Multiple Databases	344
Figure 27	Updates to Multiple Databases in Same Transaction	344
Figure 28	Updates on Multiple Databases on Multiple Servers	345
Figure 29	Update of Multiple Databases from Non-Transactional Client	346
Figure 30	Transaction Diamond Scenario with Entity Object	376
Figure 31	Transaction Diamond Scenario with a Session Bean	378
Figure 32	Location of EJB Client Stubs	402
Figure 33	Heterogeneous EJB Environment	403
Figure 34	Transaction Context Propagation	413

List of Tables

Table 1	Operations Allowed in the Methods of a Stateful Session Bean.....	94
Table 2	Operations Allowed in the Methods of a Stateless Session Bean	103
Table 3	Operations Allowed in the Methods of a Singleton Session Bean.....	117
Table 4	Operations Allowed in the Methods of a Message-Driven Bean.....	149
Table 5	Operations Allowed in the Methods of an Entity Bean	231
Table 6	Comparison of Finder and Select Methods	236
Table 7	Summary of Commit-Time Options.....	240
Table 8	Definition of the AND Operator	280
Table 9	Definition of the OR Operator	280
Table 10	Definition of the NOT Operator.....	280
Table 11	Operations Allowed in the Methods of an Entity Bean	303
Table 12	Summary of Commit-Time Options.....	312
Table 13	Container's Actions for Methods of Beans with Bean-Managed Transaction.....	366
Table 14	Transaction Attribute Summary	370
Table 15	Handling of Exceptions Thrown by a Business Interface Method or No-interface View Method of a Bean with Container-Managed Transaction Demarcation.....	385
Table 16	Handling of Exceptions Thrown by a Business Interface Method or No-Interface View Method of a Session Bean with Bean-Managed Transaction Demarcation.....	387
Table 17	Handling of Exceptions Thrown by Methods of Web Service Client View or EJB 2.1 Client View of a Bean with Container-Managed Transaction Demarcation.....	388
Table 18	Handling of Exceptions Thrown by a EJB 2.1 Client View Business Method of a Session Bean with Bean-Managed Transaction Demarcation.....	390
Table 19	Handling of Exceptions Thrown by a PostConstruct or PreDestroy Method of a Stateful or Stateless or Singleton Session Bean.....	391
Table 20	Handling of Exceptions Thrown by a Message Listener Method of a Message-Driven Bean with Container-Managed Transaction Demarcation.....	392
Table 21	Handling of Exceptions Thrown by a Message Listener Method of a Message-Driven Bean with Bean-Managed Transaction Demarcation.....	393
Table 22	Handling of Exceptions Thrown by a PostConstruct or PreDestroy Method of a Message-Driven Bean.....	393
Table 23	Handling of Exceptions Thrown by a Timeout Callback Method of an Enterprise Bean with Container-Managed Transaction Demarcation.....	394
Table 24	Handling of Exceptions Thrown by a Timeout Callback Method of an Enterprise Bean with Bean-Managed Transaction Demarcation.....	394
Table 25	Ejb-jar Annotation Processing Requirements	591
Table 26	.war Annotation Processing Requirements for enterprise beans.....	592
Table 27	Required contents of EJB 3.1 Lite and Full EJB 3.1 API	596
Table 28	Java 2 Platform Security Policy for a Standard EJB Container	601

Introduction

This is the specification of the Enterprise JavaBeans™ architecture. The Enterprise JavaBeans architecture is a architecture for the development and deployment of component-based business applications. Applications written using the Enterprise JavaBeans architecture are scalable, transactional, and multi-user secure. These applications may be written once, and then deployed on any server platform that supports the Enterprise JavaBeans specification.

1.1 Target Audience

The target audiences for this specification are the vendors of transaction processing platforms, vendors of enterprise application tools, vendors of object/relational mapping products, and other vendors who want to support the Enterprise JavaBeans (EJB) technology in their products.

Many concepts described in this document are system-level issues that are transparent to the Enterprise JavaBeans application programmer.

1.2 What is New in EJB 3.1

The Enterprise JavaBeans 3.1 architecture extends Enterprise JavaBeans to include the following new functionality and simplifications to the earlier EJB APIs:

- *A simplified Local view that provides Session Bean access without a separate Local Business interface.*
- *Packaging and deployment of EJB components directly in a .war without an ejb-jar.*
- *An embeddable API for executing EJB components within a Java SE environment.*
- *A Singleton session bean component that provides easy access to shared state, as well as application startup/shutdown callbacks.*
- *Automatically created EJB Timers.*
- *Calendar based EJB Timer expressions.*
- *Asynchronous session bean invocations.*

- *The definition of a lightweight subset of Enterprise JavaBeans functionality that can be provided within Java EE Profiles such as the Java EE Web Profile.*
- *A portable global JNDI name syntax for looking up EJB components.*

1.2.1 What Was New in EJB 3.0

The Enterprise JavaBeans 3.0 architecture extends Enterprise JavaBeans to include the following new functionality and simplifications to the earlier EJB APIs:

- *Definition of the Java language metadata annotations that can be used to annotate EJB applications. These metadata annotations are targeted at simplifying the developer's task, at reducing the number of program classes and interfaces the developer is required to implement, and at eliminating the need for the developer to provide an EJB deployment descriptor.*
- *Specification of programmatic defaults, including for metadata, to reduce the need for the developer to specify common, expected behaviors and requirements on the EJB container. A "configuration by exception" approach is taken whenever possible.*
- *Encapsulation of environmental dependencies and JNDI access through the use of annotations, dependency injection mechanisms, and simple lookup mechanisms.*
- *Simplification of the enterprise bean types.*
- *Elimination of the requirement for EJB component interfaces for session beans. The required business interface for a session bean can be a plain Java interface rather than an EJBObject, EJBLocalObject, or java.rmi.Remote interface.*
- *Elimination of the requirement for home interfaces for session beans.*
- *Simplification of entity persistence through the Java Persistence API.[2]. Support for light-weight domain modeling, including inheritance and polymorphism.*
- *Elimination of all required interfaces for persistent entities[2].*
- *Specification of Java language metadata annotations and XML deployment descriptor elements for the object/relational mapping of persistent entities [2].*
- *A query language for Java Persistence that is an extension to EJB QL, with addition of projection, explicit inner and outer join operations, bulk update and delete, subqueries, and group-by. Addition of a dynamic query capability and support for native SQL queries.*
- *An interceptor facility for session beans and message-driven beans.*
- *Reduction of the requirements for usage of checked exceptions.*
- *Elimination of the requirement for the implementation of callback interfaces.*

1.3 Acknowledgements

The EJB 3.1 specification work is being conducted as part of JSR-318 under the Java Community Process Program. This specification is the result of the collaborative work of the members of the EJB 3.1 Expert Group. These include the following present and former expert group members: BEA Systems: Patrick Linskey; Ericsson AB: Peter Kristiansson, Erik van der Velden; IBM: Randy Schnier, Soloman Barghouthi; Inria: Florent Benoit; Oracle: Jason Haley, Michael Keith, Matthew Shinn; Pramati Technologies: Deepak Anupalli; Red Hat Middleware LLC: Bill Burke, Gavin King, Carlo de Wolf; SAP AG: Ivo Simeonov, Peter Peshev; Sybase: Evan Ireland; Sun Microsystems Inc.: Linda DeMichiel, Kenneth Saks; Tmax Soft Inc.: Miju Byon, Wonseok Kim; Adam Bien; David Blevins; Antonio Goncalves; Oliver Ihns; Reza Rahman.

My colleagues at SUN also provided invaluable assistance. I would especially like to thank Linda DeMichiel for the extensive guidance and support she has provided throughout this process. I would also like to thank Bill Shannon, Roberto Chinnici, Mark Hapner, Lance Andersen, Marina Vatkina, Mahesh Kannan, Cheng Fang, Hong Zhang, and Jerome Dochez.

1.4 Organization of the Specification Documents

This specification is organized into the following two documents:

- EJB Core Contracts and Requirements
- Interceptor Requirements

This EJB Core Contracts document defines the contracts and requirements for the use and implementation of Enterprise JavaBeans. These contracts include those for the EJB 3.1 API, as well as for the EJB 2.1 API, which is also required to be supported in this release. See Chapter 21 for coverage of the Enterprise JavaBeans API requirements.

The Interceptor Requirements document defines the contracts and requirements for the use and implementation of Interceptors. These contracts, while required by the core EJB specification, are described in a way that is independent of EJB in order to facilitate their use by other enterprise Java technologies. Future revisions to Interceptors will be undertaken independently of EJB.

1.5 Document Conventions

The regular Times font is used for information that is prescriptive by the EJB specification.

The italic Times font is used for paragraphs that contain descriptive information, such as notes describing typical use, or notes clarifying the text with prescriptive specification.

The Courier font is used for code examples.

Overview

2.1 Overall Goals

The Enterprise JavaBeans (EJB) architecture has the following goals:

- *The Enterprise JavaBeans architecture will be the standard component architecture for building object-oriented business applications in the Java™ programming language.*
- *The Enterprise JavaBeans architecture will be the standard component architecture for building distributed business applications in the Java™ programming language.*
- *The Enterprise JavaBeans architecture will support the development, deployment, and use of web services.*
- *The Enterprise JavaBeans architecture will make it easy to write applications: application developers will not have to understand low-level transaction and state management details, multi-threading, connection pooling, or other complex low-level APIs.*
- *Enterprise JavaBeans applications will follow the Write Once, Run Anywhere™ philosophy of the Java programming language. An enterprise bean can be developed once, and then deployed on multiple platforms without recompilation or source code modification.*

- *The Enterprise JavaBeans architecture will address the development, deployment, and runtime aspects of an enterprise application's life cycle.*
- *The Enterprise JavaBeans architecture will define the contracts that enable tools from multiple vendors to develop and deploy components that can interoperate at runtime.*
- *The Enterprise JavaBeans architecture will make it possible to build applications by combining components developed using tools from different vendors.*
- *The Enterprise JavaBeans architecture will provide interoperability between enterprise beans and Java Platform, Enterprise Edition (Java EE) components as well as non-Java programming language applications.*
- *The Enterprise JavaBeans architecture will be compatible with existing server platforms. Vendors will be able to extend their existing products to support Enterprise JavaBeans.*
- *The Enterprise JavaBeans architecture will be compatible with other Java programming language APIs.*
- *The Enterprise JavaBeans architecture will be compatible with the CORBA protocols.*

The purpose of the EJB 3.1 release is both to continue to achieve these goals and to improve the EJB architecture by reducing its complexity from the enterprise application developer's point of view.

2.2 EJB Roles

The Enterprise JavaBeans architecture defines seven distinct roles in the application development and deployment life cycle. Each EJB Role may be performed by a different party. The EJB architecture specifies the contracts that ensure that the product of each EJB Role is compatible with the product of the other EJB Roles. The EJB specification focuses on those contracts that are required to support the development and deployment of ISV-written enterprise beans.

In some scenarios, a single party may perform several EJB Roles. For example, the Container Provider and the EJB Server Provider may be the same vendor. Or a single programmer may perform the two EJB Roles of the Enterprise Bean Provider and the Application Assembler.

The following sections define the seven EJB Roles.

2.2.1 Enterprise Bean Provider

The Enterprise Bean Provider (Bean Provider for short) is the producer of enterprise beans. His or her output is an ejb-jar file that contains one or more enterprise beans. The Bean Provider is responsible for the Java classes that implement the enterprise beans' business methods; the definition of the beans' client view interfaces; and declarative specification of the beans' metadata. The beans' metadata may take the form of metadata annotations applied to the bean classes and/or an external XML deployment descriptor. The beans' metadata—whether expressed in metadata annotations or in the deployment descriptor—includes the structural information of the enterprise beans and declares all the enterprise beans' external dependencies (e.g. the names and types of resources that the enterprise beans use).

The Enterprise Bean Provider is typically an application domain expert. The Bean Provider develops reusable enterprise beans that typically implement business tasks or business entities.

The Bean Provider is not required to be an expert at system-level programming. Therefore, the Bean Provider usually does not program transactions, concurrency, security, distribution, or other services into the enterprise beans. The Bean Provider relies on the EJB container for these services.

A Bean Provider of multiple enterprise beans often performs the EJB Role of the Application Assembler.

2.2.2 Application Assembler

The Application Assembler combines enterprise beans into larger deployable application units. The input to the Application Assembler is one or more ejb-jar files produced by the Bean Provider(s). The Application Assembler outputs one or more ejb-jar files that contain the enterprise beans along with their application assembly instructions.

The Application Assembler can also combine enterprise beans with other types of application components when composing an application.

The EJB specification describes the case in which the application assembly step occurs *before* the deployment of the enterprise beans. However, the EJB architecture does not preclude the case that application assembly is performed *after* the deployment of all or some of the enterprise beans.

The Application Assembler is a domain expert who composes applications that use enterprise beans. The Application Assembler works with the enterprise bean's metadata annotations and/or deployment descriptor and the enterprise bean's client-view contract. Although the Assembler must be familiar with the functionality provided by the enterprise bean's client-view interfaces, he or she does not need to have any knowledge of the enterprise bean's implementation.

2.2.3 Deployer

The Deployer takes one or more ejb-jar files produced by a Bean Provider or Application Assembler and deploys the enterprise beans contained in the ejb-jar files in a specific operational environment. The operational environment includes a specific EJB server and container.

The Deployer must resolve all the external dependencies declared by the Bean Provider (e.g. the Deployer must ensure that all resource manager connection factories used by the enterprise beans are present in the operational environment, and he or she must bind them to the resource manager connection factory references declared in the metadata annotations or deployment descriptor), and must follow the application assembly instructions defined by the Application Assembler. To perform his or her role, the Deployer uses tools provided by the EJB Container Provider.

The Deployer's output is a set of enterprise beans (or an assembled application that includes enterprise beans) that have been customized for the target operational environment, and that are deployed in a specific EJB container.

The Deployer is an expert at a specific operational environment and is responsible for the deployment of enterprise beans. For example, the Deployer is responsible for mapping the security roles defined by the Bean Provider or Application Assembler to the user groups and accounts that exist in the operational environment in which the enterprise beans are deployed.

The Deployer uses tools supplied by the EJB Container Provider to perform the deployment tasks. The deployment process is typically two-stage:

- *The Deployer first generates the additional classes and interfaces that enable the container to manage the enterprise beans at runtime. These classes are container-specific.*
- *The Deployer performs the actual installation of the enterprise beans and the additional classes and interfaces into the EJB container.*

In some cases, a qualified Deployer may customize the business logic of the enterprise beans at their deployment. Such a Deployer would typically use the Container Provider's tools to write relatively simple application code that wraps the enterprise bean's business methods.

2.2.4 EJB Server Provider

The EJB Server Provider is a specialist in the area of distributed transaction management, distributed objects, and other lower-level system-level services. A typical EJB Server Provider is an OS vendor, middleware vendor, or database vendor.

The current EJB architecture assumes that the EJB Server Provider and the EJB Container Provider roles are the same vendor. Therefore, it does not define any interface requirements for the EJB Server Provider.

2.2.5 EJB Container Provider

The EJB Container Provider (Container Provider for short) provides:

- The deployment tools necessary for the deployment of enterprise beans.
- The runtime support for the deployed enterprise bean instances.

From the perspective of the enterprise beans, the container is a part of the target operational environment. The container runtime provides the deployed enterprise beans with transaction and security management, network distribution of remote clients, scalable management of resources, and other services that are generally required as part of a manageable server platform.

The “EJB Container Provider’s responsibilities” defined by the EJB architecture are meant to be requirements for the implementation of the EJB container and server. Since the EJB specification does not architect the interface between the EJB container and server, it is left up to the vendor how to split the implementation of the required functionality between the EJB container and server.

The expertise of the Container Provider is system-level programming, possibly combined with some application-domain expertise. The focus of a Container Provider is on the development of a scalable, secure, transaction-enabled container that is integrated with an EJB server. The Container Provider insulates the enterprise bean from the specifics of an underlying EJB server by providing a simple, standard API between the enterprise bean and the container. This API is the Enterprise JavaBeans component contract.

The Container Provider typically provides support for versioning the installed enterprise bean components. For example, the Container Provider may allow enterprise bean classes to be upgraded without invalidating existing clients or losing existing enterprise bean objects.

The Container Provider typically provides tools that allow the System Administrator to monitor and manage the container and the beans running in the container at runtime.

2.2.6 Persistence Provider

The expertise of the Persistence Provider is in object/relational mapping, query processing, and caching. The focus of the Persistence Provider is on the development of a scalable, transaction-enabled runtime environment for the management of persistence.

The Persistence Provider provides the tools necessary for the object/relational mapping of persistent entities to a relational database, and the runtime support for the management of persistent entities and their mapping to the database.

The Persistence Provider insulates the persistent entities from the specifics of the underlying persistence substrate, providing a standard API between the persistent entities and the object/relational runtime.

The Persistence Provider may be the same vendor as the EJB Container vendor or the Persistence Provider may be a third-party vendor that provides a pluggable persistence environment as described in [2].

2.2.7 System Administrator

The System Administrator is responsible for the configuration and administration of the enterprise’s computing and networking infrastructure that includes the EJB server and container. The System Administrator is also responsible for overseeing the well-being of the deployed enterprise beans applications at runtime.

2.3 Enterprise Beans

Enterprise JavaBeans is an architecture for component-based transaction-oriented enterprise applications.

2.3.1 Characteristics of Enterprise Beans

The essential characteristics of an enterprise bean are:

- An enterprise bean typically contains business logic that operates on the enterprise's data.
- An enterprise bean's instances are managed at runtime by a container.
- An enterprise bean can be customized at deployment time by editing its environment entries.
- Various service information, such as transaction and security attributes, may be specified together with the business logic of the enterprise bean class in the form of metadata annotations, or separately, in an XML deployment descriptor. This service information may be extracted and managed by tools during application assembly and deployment.
- Client access is mediated by the container in which the enterprise bean is deployed.
- If an enterprise bean uses only the services defined by the EJB specification, the enterprise bean can be deployed in any compliant EJB container. Specialized containers can provide additional services beyond those defined by the EJB specification. An enterprise bean that depends on such a service can be deployed only in a container that supports that service.
- An enterprise bean can be included in an assembled application without requiring source code changes or recompilation of the enterprise bean.
- The Bean Provider defines a client view of an enterprise bean. The Bean Provider can manually define the client view or it can be generated automatically by application development tools. The client view is unaffected by the container and server in which the bean is deployed. This ensures that both the beans and their clients can be deployed in multiple execution environments without changes or recompilation.

2.3.2 Flexible Model

The enterprise bean architecture is flexible enough to implement the following:

- An object that represents a stateless service.
- An object that represents a stateless service and that implements a web service endpoint.
- An object that represents a stateless service and whose invocation is asynchronous, driven by the arrival of messages.

- An object that represents a conversational session with a particular client. Such session objects automatically maintain their conversational state across multiple client-invoked methods.
- An entity object that represents a fine-grained persistent object.

Enterprise beans that are remotely accessible components are intended to be relatively coarse-grained business objects (e.g. shopping cart, stock quote service). Fine-grained objects (e.g. employee record, line items on a purchase order) should be modeled as light weight persistent entities, as described in [2], not as remotely accessible components.

Although the state management protocol defined by the Enterprise JavaBeans architecture is simple, it provides an enterprise bean developer great flexibility in managing a bean's state.

2.4 Session, Entity, and Message-Driven Objects

The Enterprise JavaBeans architecture defines the following types of enterprise bean objects:

- A session object.
- A message-driven object.
- An entity object.

2.4.1 Session Objects

A typical session object has the following characteristics:

- *Executes on behalf of a single client.*
- *Can be transaction-aware.*
- *Updates shared data in an underlying database.*
- *Does not represent directly shared data in the database, although it may access and update such data.*
- *Is relatively short-lived.*
- *Is removed when the EJB container crashes. The client has to re-establish a new session object to continue computation.*

A typical EJB container provides a scalable runtime environment to execute a large number of session objects concurrently.

*The EJB specification defines **stateful**, **stateless**, and **singleton session beans**. There are differences in the API between stateful session beans, stateless session beans, and singleton session beans.*

2.4.2 Message-Driven Objects

A typical message-driven object has the following characteristics:

- *Executes upon receipt of a single client message.*
- *Is asynchronously invoked.*
- *Can be transaction-aware.*
- *May update shared data in an underlying database.*
- *Does not represent directly shared data in the database, although it may access and update such data.*
- *Is relatively short-lived.*
- *Is stateless.*
- *Is removed when the EJB container crashes. The container has to re-establish a new message-driven object to continue computation.*

A typical EJB container provides a scalable runtime environment to execute a large number of message-driven objects concurrently.

2.4.3 Entity Objects

A typical entity object has the following characteristics:

- *Is part of a domain model, providing an object view of data in the database.*
- *Can be long-lived (lives as long as the data in the database).*
- *The entity and its primary key survive the crash of the EJB container. If the state of an entity was being updated by a transaction at the time the container crashed, the entity's state is restored to the state of the last committed transaction when the entity is next retrieved.*

A typical EJB container and server provide a scalable runtime environment for a large number of concurrently active entity objects.

2.5 Standard Mapping to CORBA Protocols

To help interoperability for EJB environments that include systems from multiple vendors, the EJB specification requires compliant implementations to support the interoperability protocol based on CORBA/IIOP for remote invocations from Java EE clients. Implementations may support other remote invocation protocols in addition to IIOP.

Chapter 15 summarizes the requirements for support for distribution and interoperability.

2.6 Mapping to Web Service Protocols

To support web service interoperability, the EJB specification requires compliant implementations to support XML-based web service invocations using WSDL and SOAP or plain XML over HTTP in conformance with the requirements of the JAX-WS [32], JAX-RPC [25], Web Services for Java EE [31], and Web Services Metadata for the Java Platform [30] specifications.

2.7 Pruning the EJB API

The Java EE 6 Specification has adopted the process defined by the Java SE group for “pruning” technologies from the platform in a careful and orderly way that minimizes the impact to developers using these technologies while allowing the platform to grow even stronger.

As part of this process the EJB 3.1 Specification will propose a list of features for possible *future* removal. *None* of the proposed removal items will actually be removed during this release. Instead, for each feature on the proposed removal list, the next version of the EJB Specification will either remove the feature from the release, retain it as a required component, or leave it in the “proposed removal” state for future evaluation.

The result of successfully applying this process to a feature is not the actual deletion of the feature but rather the conversion of the feature from a required part of the EJB API into an optional part of the EJB API. No actual removal from the specification occurs, although the feature may be removed from products at the choice of the product vendor.

This specification proposes the following set of features for future removal :

- EJB 1.1 Entity Bean Component Contract for Container-Managed Persistence
- EJB 2.1 Entity Bean Component Contract for Bean-Managed Persistence
- EJB 2.1 Entity Bean Component Contract for Container-Managed Persistence
- Client View of an EJB 2.1 Entity Bean
- EJB QL : EJB 2.1 Query Language for Container-Managed Persistence Query Methods
- JAX-RPC Based Web Service Endpoints
- JAX-RPC Web Service Client View

2.8 Relationship to Managed Bean Specification

The Managed Beans 1.0 Specification defines the minimal requirements for container-managed objects, otherwise known under the acronym “POJOs” (Plain Old Java Objects), within the Java EE Platform. Managed Beans support a small set of basic services, such as resource injection, lifecycle callbacks and interceptors.

A Session Bean component is a Managed Bean. The EJB component model extends the basic Managed Bean model in many areas(component definition, naming, lifecycle, threading, etc.)

Client View of a Session Bean

This chapter describes the client view of a session bean. The session bean itself implements the business logic. The bean's container provides functionality for remote access, security, concurrency, transactions, and so forth.

While classes implemented by the container provide the client view of the session bean, the container itself is transparent to the client.

3.1 Overview

For a client, a session object is a non-persistent object that implements some business logic running on the server. One way to think of a session object is as a logical extension of the client program that runs on the server. A typical session object is not shared among multiple clients.

A client never directly accesses instances of the session bean's class. A client accesses a session object through the session bean's client view.

The client of a session bean may be a local client, a remote client, or a web service client, depending on which of these views is provided by the bean and used by the client.

A remote client of an session bean can be another enterprise bean deployed in the same or different container; or it can be an arbitrary Java program, such as an application, applet, or servlet. The client view of a session bean can also be mapped to non-Java client environments, such as CORBA clients that are not written in the Java programming language.

The interface used by a remote client of a session bean is implemented by the container as a remote business interface (or a remote EJBObject interface), and the remote client view of a session bean is location-independent. A client running in the same JVM as the session object uses the same API as a client running in a different JVM on the same or different machine.

Terminology note: *This specification uses the term **remote business interface** to refer to the business interface of an EJB 3.x session bean that supports remote access. The term **remote interface** is used to refer to the remote component interface of the EJB 2.1 client view. The term **local business interface** refers to the local business interface of an EJB 3.x session bean that supports local access. The term **local interface** is used to refer to the local component interface of the EJB 2.1 client view.*

Use of a session bean's local client view entails the collocation of the local client and the session. The local client of an enterprise bean must be collocated in the same container as the bean. The local client view is not location-independent.

The client of a stateless session bean or singleton session bean may be a web service client. Only a *stateless* session bean or *singleton* session bean may provide a web service client view. A web service client makes use of the enterprise bean's web service client view, as described by a WSDL document. The bean's client view web service endpoint is in terms of a JAX-WS endpoint [32] or JAX-RPC endpoint interface [25]. Web service clients are discussed in Sections 3.2.4 and 3.5.

While it is possible to provide more than one client view for a session bean, typically only one will be provided.

The considerations that should be taken into account in determining the client view to be used for a session bean are further described in Section 3.2, "Local, Remote, and Web Service Client Views".

A client can invoke a session bean *synchronously* or *asynchronously*. An asynchronous method can return a `Future<V>` object that allows the client to retrieve a result value, check for exceptions, or attempt to cancel an in-progress invocation.

From its creation until destruction, a session object lives in a container. The container provides security, concurrency, transactions, swapping to secondary storage, and other services for the session object transparently to the client.

Each session object has an identity which, in general, *does not* survive a crash and restart of the container, although a high-end container implementation can mask container and server crashes to a remote or web service client.

Multiple enterprise beans can be installed in a container. The container allows the clients of session beans that provide local or remote client views to obtain the business interfaces and/or home interfaces of the installed enterprise beans through dependency injection or to look them up via JNDI.

The client view of a session object is independent of the implementation of the session bean and the container.

3.2 Local, Remote, and Web Service Client Views

This section describes some of the considerations the Bean Provider should take into account in determining the client view to provide for an enterprise bean.

3.2.1 Remote Clients

In EJB 3.x, a remote client accesses a session bean through the bean's remote business interface. For a session bean client and component written to the EJB 2.1 and earlier APIs, the remote client accesses the session bean through the session bean's remote home and remote component interfaces.

Compatibility Note: The EJB 2.1 and earlier API required that a remote client access the stateful or stateless session bean by means of the session bean's remote home and remote component interfaces. These interfaces remain available for use with EJB 3.x, and are described in Section 3.6.

The remote client view of an enterprise bean is location independent. A client running in the same JVM as a bean instance uses the same API to access the bean as a client running in a different JVM on the same or different machine.

The arguments and results of the methods of the remote business interface are passed by value.

3.2.2 Local Clients

Session beans may have local clients. A local client is a client that is collocated in the same JVM with the session bean that provides the local client view and which may be tightly coupled to the bean. A local client of a session bean may be another enterprise bean or a web component.

Access to an enterprise bean through the local client view requires the collocation in the same JVM of both the local client and the enterprise bean that provides the local client view. The local client view therefore does not provide the location transparency provided by the remote client view.

Access to an enterprise bean through the local client view is only required to be supported for local clients packaged within the same application as the enterprise bean that provides the local client view. Compliant implementations of this specification may optionally support access to the local client view of an enterprise bean from a local client packaged in a different application. The configuration requirements for inter-application access to the local client view are vendor-specific and are outside the scope of this specification. Applications relying on inter-application access to the local client view are non-portable.

In EJB 3.x, a local client accesses a session bean through the bean's local business interface or through a no-interface client view representing all the public methods of the bean class. For a session bean or entity bean client and component written to the EJB 2.1 and earlier APIs, the local client accesses the enterprise bean through the bean's local home and local component interfaces. The container object that implements a local business interface or the no-interface local view is a local Java object.

Compatibility Note: The EJB 2.1 and earlier API required that a local client access the stateful or stateless session bean by means of the session bean's local home and local component interfaces. These interfaces remain available for use with EJB 3.x, and are described in Section 3.6.

The arguments and results of the methods of the local client view are passed “by reference”^[1]. Enterprise beans that provide a local client view should therefore be coded to assume that the state of any Java object that is passed as an argument or result is potentially shared by caller and callee.

The Bean Provider must be aware of the potential sharing of objects passed through invocations of the local client view. In particular, the Bean Provider must be careful that the state of one enterprise bean is not assigned as the state of another. In general, the references that are passed across invocations of the local client view cannot be used outside of the immediate call chain and must never be stored as part of the state of another enterprise bean. The Bean Provider must also exercise caution in determining which objects to pass across the local view. This caution applies particularly in the case where there is a change in transaction or security context.

3.2.3 Choosing Between a Local or Remote Client View

The following considerations should be taken into account in determining whether a local or remote access should be used for an enterprise bean.

- The remote programming model provides location independence and flexibility with regard to the distribution of components in the deployment environment. It provides a loose coupling between the client and the bean.
- Remote calls involve pass-by-value. This copy semantics provides a layer of isolation between caller and callee, and protects against the inadvertent modification of data. The client and the bean may be programmed to assume this parameter copying.
- Remote calls are potentially expensive. They involve network latency, overhead of the client and server software stacks, argument copying, etc. Remote calls are typically programmed in a coarse-grained manner with few interactions between the client and bean.
- The objects that are passed as parameters on remote calls must be serializable.
- When the EJB 2.1 and earlier remote home and remote component interfaces are used, the narrowing of remote types requires the use of `javax.rmi.PortableRemoteObject.narrow` rather than Java language casts.
- Remote calls may involve error cases due to communication, resource usage on other servers, etc., which are not expected in local calls. When the EJB 2.1 and earlier remote home and remote component interfaces are used, the client has to explicitly program handlers for handling the `java.rmi.RemoteException`.

[1] More literally, references are passed by value in the JVM: an argument variable of primitive type holds a value of that primitive type; an argument variable of a reference type hold a reference to the object. See [28].

- Because of the overhead of the remote programming model, it is typically used for relatively coarse-grained component access.
- Local calls involve pass-by-reference. The client and the bean may be programmed to rely on pass-by-reference semantics. For example, a client may have a large document which it wants to pass on to the bean to modify, and the bean further passes on. In the local programming model the sharing of state is possible. On the other hand, when the bean wants to return a data structure to the client but the bean does not want the client to modify it, the bean explicitly copies the data structure before returning it, while in the remote programming model the bean does not copy the data structure because it assumes that the system will do the copy.
- Because local calls involve pass-by-reference, the local client and the enterprise bean providing the local client view are collocated.
- The collocation entailed by the local programming model means that the enterprise bean cannot be deployed on a node different from that of its client—thus restricting the distribution of components.
- Because the local programming model provides more lightweight access to a component, it better supports more fine-grained component access.

Note that although collocation of the remote client and the enterprise bean may allow the container to reduce the overhead of calls through a remote business interface or remote component interface, such calls are still likely to be less efficient than calls made using a local interface because any optimizations based on collocation must be done transparently.

The choice between the local and the remote programming model is a design decision that the Bean Provider makes when developing the enterprise bean.

While it is possible to provide both a remote client view and a local client view for an enterprise bean, more typically only one or the other will be provided.

3.2.4 Web Service Clients

Stateless session beans and Singleton session beans may have web service clients.

A web service client accesses a session bean through the web service client view. The web service client view is described by the WSDL document for the web service that the bean implements. WSDL is an XML format for describing a web service as a set of endpoints operating on messages. The abstract description of the service is bound to an XML based protocol (SOAP [27]) and underlying transport (HTTP or HTTPS) by means of which the messages are conveyed between client and server. (See references [25], [26], [30], [31], [32]).

The web service methods of a session bean provide the basis of the web service client view of the bean that is exported through WSDL. See references [30] and [25] for a description of how Java language metadata annotations may be used to specify a session bean's web services client view.

Compatibility Note: EJB 2.1 required the Bean Provider to define a web service endpoint interface for a stateless session bean when he or she wished to expose the functionality of the bean as a web service endpoint through WSDL. This requirement to define the web service endpoint interface is removed in EJB 3.0 and later. See [30].

A bean's web service client view may be initially defined by a WSDL document and then mapped to a web service endpoint that conforms to this, or an existing bean may be adapted to provide a web service client view. Reference [31] describes various design-time scenarios that may be used for EJB web service endpoints.

The web service client view of an enterprise bean is location independent and remotable.

Web service clients may be Java clients and/or clients not written in the Java programming language. A web service client that is a Java client accesses the web service by means of the JAX-WS or JAX-RPC client APIs. Access through web service clients occurs through SOAP 1.1, SOAP 1.2 or plain XML over HTTP(S).

While it is possible to provide a web service client view in addition to other client views for an enterprise bean, more typically only one will be provided. There is no prohibition against using the same interface as both a Remote business interface and a web service endpoint interface. In that case it is the Bean Developer's responsibility to ensure that the interface conforms to the type requirements of each client view through which it is exposed.

3.3 EJB Container

An EJB container (container for short) is a system that functions as the "container" for enterprise beans. Multiple enterprise beans can be deployed in the same container. The container is responsible for making the business interfaces and/or home interfaces of its deployed enterprise beans available to the client through dependency injection and/or through lookup in the JNDI namespace.

3.4 Client View of Session Beans Written to the EJB 3.x Simplified API

The EJB 3.x local or remote client of a session bean written to the EJB 3.x API accesses a session bean through its business interface. The business interface of an EJB 3.x session bean is an ordinary Java interface, regardless of whether local or remote access is provided for the bean. In particular, the EJB 3.x session bean business interface is not one of the interface types required by earlier versions of the EJB specification (i.e., EJBObject or EJBLocalObject interface). A local client may also access a session bean through a no-interface view that exposes all public methods of the bean class.

3.4.1 Obtaining a Session Bean's Business Interface

A client can obtain a session bean's business interface through dependency injection or lookup in the JNDI namespace.

For example, the business interface `Cart` for the `CartBean` session bean may be obtained using dependency injection as follows:

```
@EJB Cart cart;
```

The `Cart` business interface could also be looked up using JNDI as shown in the following code segment using the `lookup` method provided by the `EJBContext` interface. In this example, a reference to the client bean's `SessionContext` object is obtained through dependency injection:

```
@Resource SessionContext ctx;  
...  
Cart cart = (Cart)ctx.lookup("cart");
```

In both cases, the syntax used in obtaining the reference to the `Cart` business interface is independent of whether the business interface is local or remote. In the case of remote access, the actual location of a referenced enterprise bean and EJB container are, in general, transparent to the client using the remote business interface of the bean.

3.4.2 Obtaining a Reference to the No-interface View

A client can obtain a reference to a Session Bean's No-interface View through dependency injection or lookup in the JNDI namespace.

For example, the No-interface view of the `CartBean` session bean with bean class `com.acme.CartBean` may be obtained using dependency injection as follows :

```
@EJB CartBean cart;
```

The `CartBean` No-interface view could also be looked up via JNDI as shown in the following code segment using the `lookup` method provided by the `EJBContext` interface. In this example, a reference to the client bean's `SessionContext` is obtained through dependency injection:

```
@Resource SessionContext ctx;  
...  
CartBean cart = (CartBean)ctx.lookup("cart");
```

Despite the fact that the client reference for the No-interface view has type `<bean class>` , the client never directly uses the `new` operator to acquire the reference.

3.4.3 Session Bean's Business Interface

The session bean's interface is an ordinary Java interface. It contains the business methods of the session bean.

A reference to a session bean's business interface may be passed as a parameter or return value of a business interface method. If the reference is to a session bean's local business interface, the reference may only be passed as a parameter or return value of a local business interface method or a No-interface view method.

The business interface of a stateful session bean typically contains a method to initialize the state of the session object and a method to indicate that the client has finished using the session object and that it can be removed. See Chapter 4, “Session Bean Component Contract”.

It is invalid to reference a session object that does not exist. If a stateful session bean has been removed, attempted invocations on the stateful session bean business interface result in a `javax.ejb.NoSuchEJBException`.^[2] If a Singleton session bean did not successfully initialize, attempted invocations on the singleton session bean business interface result in a `javax.ejb.NoSuchEJBException`.

The container provides an implementation of a session bean’s business interface such that when the client invokes a method on the instance of the business interface, the business method on the session bean instance and any interceptor methods are invoked as needed.

The container makes the session bean’s business interface available to the EJB 3.x client through dependency injection and through lookup in the JNDI namespace. Section 16.5 describes in further detail how clients can obtain references to EJB business interfaces.

3.4.4 Session Bean’s No-Interface View

A Session Bean’s no-interface view is a variation of the Local view that exposes the public methods of the bean class without the use of a separate business interface.

A reference to the no-interface view may be passed as a parameter or return value of any Local business interface or no-interface view method.

The container provides an implementation of a reference to a no-interface view such that when the client invokes a method on the reference, the business method on the session bean instance and any interceptor methods are invoked as needed. As with the session bean remote and local views, a client acquires a no-interface view reference via lookup or injection only. A client does *not* directly instantiate (use the `new` operator on) the bean class to acquire a reference to the no-interface view.

Only public methods of the bean class (and any super-classes) may be invoked through the no-interface view. Attempted invocations of methods with any other access modifiers via the no-interface view reference must result in a `javax.ejb.EJBException`.

When interacting with a reference to the no-interface view, the client must not make any assumptions regarding the internal implementation of the reference, such as any instance-specific state that may be present in the reference. Although the reference object is type-compatible with the corresponding bean class type, there is no prescribed relationship between the internal implementation of the reference and the implementation of the bean instance.

The developer of an enterprise bean that exposes a no-interface view must not make any assumptions about the number of times the bean class no-arg constructor will be called. For example, it is possible that the acquisition of a client reference to the no-interface view will result in the invocation of the bean-class constructor. It is recommended that the bean developer place component initialization logic in a `@PostConstruct` method instead of the bean class no-arg constructor.

[2] This may not apply to stateless session beans; see Section 4.7.

It is invalid to reference a session object that does not exist. If a stateful session bean has been removed, attempted invocations on the no-interface view reference must result in a `javax.ejb.NoSuchEJBException`. If a Singleton session bean did not successfully initialize, attempted invocations on the singleton no-interface view reference result in a `javax.ejb.NoSuchEJBException`.

3.4.5 Client View of Session Object's Life Cycle

From the point of view of the client, a session object exists once the client has obtained a reference to its business interface—whether through dependency injection or from lookup of the business interface in JNDI.

A client that has a reference to a session object's business interface can then invoke business methods on the interface and/or pass the reference as a parameter or return value of a business interface method.^[3]

A client may remove a stateful session bean by invoking a method of its business interface designated as a `Remove` method.

The lifecycle of a stateless session bean does not require that it be removed by the client. Removal of a stateless session bean instance is performed by the container, transparently to the client.

The lifecycle of a singleton session bean does not require that it be removed by the client. Removal of a singleton session bean instance is performed by the container, transparently to the client.

The contracts for session bean lifecycle are described in Chapter 4, "Session Bean Component Contract".

3.4.6 Example of Obtaining and Using a Session Object

An example of the session bean runtime objects is illustrated by the following diagram:

[3] Note that the EJB 3.x session bean business interface is not an `EJBObject`. It is not valid to pass a reference to the remote business interface through a bean's remote component interface.

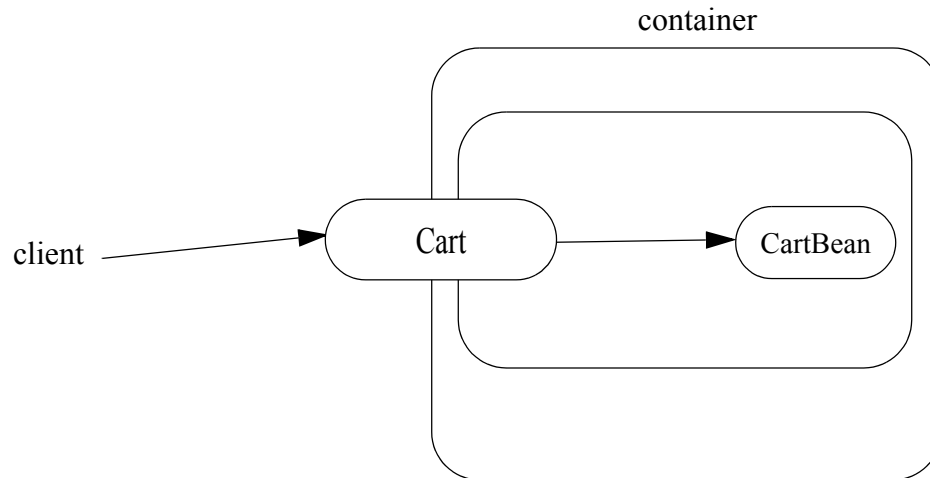
Figure 1 Session Bean Example Objects

A client obtains a reference to a `Cart` session object, which provides a shopping service, by means of dependency injection or using JNDI lookup. The client then uses this session object to fill the cart with items and to purchase its contents. `Cart` is a stateful session.

In this example, the client obtains a reference to the `Cart`'s business interface through dependency injection. The client then uses the business interface to initialize the session object and add a few items to it. The `startShopping` method is a business method that is provided for the initialization of the session object.

```
@EJB Cart cart;  
...  
cart.startShopping();  
cart.addItem(66);  
cart.addItem(22);
```

Finally the client purchases the contents of the shopping cart, and finishes the shopping activity.^[4]

```
cart.purchase();  
cart.finishShopping();
```

[4] It is part of the logic of an application designed using stateful session beans to designate a method that causes the removal of the stateful session (and thus allows for the reclamation of resources used by the session bean). This example assumes that the `finishShopping` method is such a Remove method. See Section 4.6 for further discussion.

3.4.7 Session Object Identity

A client can test two EJB 3.x Remote/Local view references for identity by means of the `Object.equals` and `Object.hashCode` methods.

3.4.7.1 Stateful Session Beans

A stateful session object has a unique identity that is assigned by the container at the time the object is created. A client of the stateful session bean business interface can determine if two business interface or no-interface view references refer to the same session object by use of the `equals` method.

For example,

```
@EJB Cart cart1;
@EJB Cart cart2;
...
if (cart1.equals(cart1)) { // this test must return true
    ...
}
...
if (cart1.equals(cart2)) { // this test must return false
    ...
}
```

All stateful session bean references to the same business interface for the same stateful session bean instance will be equal. All references to the no-interface view of the same stateful session bean instance will be equal. Stateful session bean references to different interface types or between an interface type and a no-interface view or to different session bean instances will not have the same identity.

3.4.7.2 Stateless Session Beans

All business object references of the same interface type for the same stateless session bean have the same object identity, which is assigned by the container. All references to the no-interface view of the same stateless session bean have the same object identity.

For example,

```
@EJB Cart cart1;
@EJB Cart cart2;
...
if (cart1.equals(cart1)) { // this test must return true
    ...
}
...
if (cart1.equals(cart2)) { // this test must also return true
    ...
}
```

The `equals` method always returns true when used to compare references to the same business interface type of the same stateless session bean. The `equals` method always returns true when used to compare references to the no-interface view of the same stateless session bean. Stateless session bean references to either different business interface types or between an interface type and a no-interface view or to different session beans will not be equal.

3.4.7.3 Singleton Session Beans

All business object references of the same interface type for the same singleton session bean have the same object identity, which is assigned by the container. All references to the no-interface view of the same singleton session bean have the same object identity.

For example,

```
@EJB Shared shared1;
@EJB Shared shared2;
...
if (shared1.equals(shared1)) { // this test must return true
    ...
}
...
if (shared1.equals(shared2)) { // this test must also return true
    ...
}
```

The `equals` method always returns true when used to compare references to the same business interface type of the same singleton session bean. The `equals` method always returns true when used to compare references to the no-interface view of the same singleton session bean. Session bean references to either different business interface types or between an interface type and a no-interface view or to different session beans will not be equal.

3.4.8 Asynchronous Invocations

By default, session bean invocations through the Remote, Local, and no-interface views are *synchronous*. The client blocks for the duration of the invocation and is returned control only after all invocation processing has completed. Clients can achieve *asynchronous* invocation behavior by invoking session bean methods that have been designed to support asynchrony.

When a client invokes an asynchronous method, the container returns control to the client immediately and continues processing the invocation on a separate thread of execution.

The client should expect to receive a system exception (in the form of a `javax.ejb.EJBException`) on the client thread if the container has problems allocating the internal resources required to support the asynchronous method.^[5] If a system exception is received on the client thread, the client can expect that the container will not be able to dispatch the asynchronous method. The client may wish to retry the asynchronous method at a later time.

[5] If the business interface is a remote business interface that extends `java.rmi.Remote`, a `java.rmi.RemoteException` is received instead.

If no system exception is received, then the client can expect that the container will make an attempt to dispatch the asynchronous method. An exception resulting from the asynchronous method execution (e.g. an authorization failure, transaction commit failure, application exception, etc.) will be available via the `Future<V>` object.

3.4.8.1 Return Values

Asynchronous methods have a return type of `void` or `Future<V>`, where `V` represents the result value of the asynchronous invocation.

For `Future<V>`, the object returned from the client invocation is a container provided object. This object allows the client to retrieve the invocation result value, discover any invocation exception, or attempt to cancel the asynchronous invocation.

All methods of the `java.util.concurrent.Future` interface are supported. Unless otherwise noted, the behavior matches that described in its javadoc entry [34].

3.4.8.1.1 `Future.cancel(boolean mayInterruptIfRunning)`

If a client calls `cancel` on its `Future` object, the container will attempt to cancel the associated asynchronous invocation *only if* that invocation has not already been dispatched. There is no guarantee that an asynchronous invocation can be cancelled, regardless of how quickly `cancel` is called after the client receives its `Future` object. If the asynchronous invocation can not be cancelled, the method must return `false`. If the asynchronous invocation is successfully cancelled, the method must return `true`.

The `mayInterruptIfRunning` flag controls whether, in the case that the asynchronous invocation can *not* be cancelled, the target enterprise bean should have visibility to the client's cancel attempt. If the `mayInterruptIfRunning` is set to `true`, then subsequent calls to the `SessionContext.wasCancelCalled` method from within the associated dispatched asynchronous invocation must return `true`. If the `mayInterruptIfRunning` is set to `false`, then subsequent calls to the `SessionContext.wasCancelCalled` method from within the associated dispatched asynchronous invocation must return `false`.

Note that all the client `Future` cancel semantics (`isCancelled`, `CancellationException`, etc.) depend only on the result of `Future.cancel`. If the dispatched asynchronous method does decide to short circuit its processing as a result of checking `SessionContext`, it's up to the Bean Developer to decide how to convey that information to the client. Typically, that is done through a special return value or exception delivered via `Future.get()`.

3.4.8.1.2 `Future.get`

The client calls one of the two `Future.get` methods in order to retrieve the result value or resulting exception from the associated asynchronous invocation. The specification recommends that unless the client successfully cancels the asynchronous invocation it should call `get` on every `Future` object it receives. If a call to `get` successfully returns a result value or throws an `ExecutionException`, all subsequent calls to `get` on the same `Future` object must result in that same behavior.

An EJB Container Provider is permitted to define a timeout value that governs the maximum amount of time the container maintains result values for completed asynchronous invocations. The configuration of such a timeout is beyond the scope of this specification.

3.4.9 Concurrent Access to Session Bean References

It is permissible to acquire a session bean reference and attempt to invoke the same reference object concurrently from multiple threads. However, the resulting client behavior on each thread depends on the concurrency semantics of the target bean. See Section 4.3.14 and Section 4.8.5 for details of the concurrency behavior for session beans.

3.5 The Web Service Client View of a Session Bean

From the perspective of the client, the existence of the stateless session bean or singleton session bean is completely hidden behind the web service endpoint that the bean implements.

The web service client's access to the web service functionality provided by a session bean occurs through a web service endpoint. In the case of Java clients, this endpoint is accessed as a JAX-WS or JAX-RPC service endpoint using the JAX-WS or JAX-RPC client view APIs, as described in [32] and [25].

The following diagram illustrates the view that is provided to Java EE web service clients of a stateless session bean through the JAX-WS client view APIs.

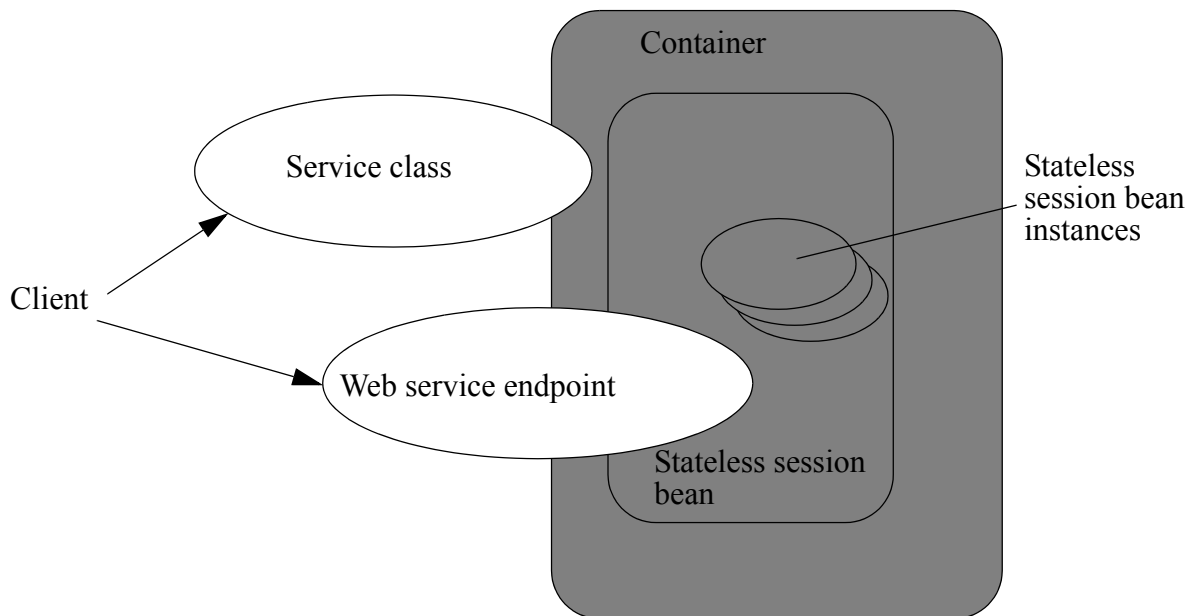
Figure 2 Web Service Client View of Stateless Session Beans Deployed in a Container

3.5.1 JAX-WS Web Service Clients

The Java EE web service client obtains a reference to the service instance of the `javax.xml.ws.Service` class through dependency injection or using JNDI. The service class can be a generic `javax.xml.ws.Service` class or a generated service class which extends the `javax.xml.ws.Service` class. The service instance is then used to obtain a port object for the web service endpoint. The mechanisms and APIs for client web service access are described in the JAX-WS specification [32] and in the Web Services for Java EE specification [31].

The following example illustrates how a JAX-WS client obtains a reference to a web service endpoint, obtains a port object for the web service endpoint, and invokes a method on that endpoint.

```
@WebServiceRef
public StockQuoteService stockQuoteService;
...
StockQuoteProvider sqp =
    stockQuoteService.getStockQuoteProviderPort();
float quotePrice = sqp.getLastTradePrice("ACME");
...
```

The use of service references and the `WebServiceRef` annotation are described in further detail in [32].

3.5.2 JAX-RPC Web Service Clients

The JAX-RPC web service client obtains a reference to the service object that implements the `javax.xml.rpc.Service` interface through dependency injection or using JNDI. The service interface can be a generic `javax.xml.rpc.Service` interface or a generated service interface which extends the `javax.xml.rpc.Service` interface. The service interface is then used to obtain a stub or proxy that implements the session bean's web service endpoint interface. The mechanisms and APIs for client web service access are described in the JAX-RPC specification [25] and in the Web Services for Java EE specification [31].

The following example illustrates how a Java EE client looks up a web service in JNDI using a logical name called a service reference (specified using the `service-ref` element), obtains a stub instance for a web service endpoint, and invokes a method on that endpoint.

```
Context ctx = new InitialContext();
com.example.StockQuoteService sqs = (com.example.StockQuoteService)
    ctx.lookup("java:comp/env/service/StockQuoteService");
com.example.StockQuoteProvider sqp =
    sqs.getStockQuoteProviderPort();
float quotePrice = sqp.getLastTradePrice("ACME");
...
```

The use of service references and the `service-ref` deployment descriptor element are described in further detail in [31].

The JAX-RPC Web Service Client view has been proposed for future removal. See Section 2.7 for more details.

3.6 Remote and Local Client View of Session Beans Written to the EJB 2.1 Client View API

The remainder of this chapter describes the Session Bean client view defined by the EJB 2.1 and earlier specifications. Support for the definition and use of these earlier client interfaces is required to be provided by implementations of the EJB 3.1 specification. The EJB 2.1 Remote and Local client view is not supported for singleton session beans.

3.6.1 Locating a Session Bean's Home Interface

The EJB 2.1 and earlier specifications require that the client first obtain a reference to a session bean's home interface, and then use the home interface to obtain a reference to the bean's component interface. This earlier programming model continues to be supported in EJB 3.1. Both dependency injection and use of the `EJBContext lookup` method may be used as an alternative to the JNDI APIs to obtain a reference to the home interface.

For example, an EJB 3.x client, `com.acme.example.MySessionBean`, might obtain a reference to a bean's home interface as follows:

```
@EJB CartHome cartHome;
```

This home interface could be looked up in JNDI using the `EJBContext lookup` method as shown in the following code segment:

```
@Resource SessionContext ctx;
...
CartHome cartHome =
    (CartHome) ctx.lookup("com.acme.example.MySessionBean/cartHome");
```

When the `EJBContext lookup` method is used to look up a home interface, the use of `javax.rmi.PortableRemoteObject.narrow` is not required.

The following code segments illustrate how the home interface is obtained when the JNDI APIs are used directly, as was required in the EJB 2.1 programming model. For example, the remote home interface for the `Cart` session bean can be located using the following code segment:

```
Context initialContext = new InitialContext();
CartHome cartHome = (CartHome) javax.rmi.PortableRemoteObject.narrow(
    initialContext.lookup("java:comp/env/ejb/cart"),
    CartHome.class);
```

If the `Cart` session bean provides a local client view instead of a remote client view and `CartHome` is a local home interface, this lookup might be as follows:

```
Context initialContext = new InitialContext();
CartHome cartHome = (CartHome)
    initialContext.lookup("java:comp/env/ejb/cart");
```

3.6.2 Session Bean's Remote Home Interface

This section is specific to session beans that provide a remote client view using the remote and remote home interfaces.

This was the only way of providing a remote client view in EJB 2.1 and earlier releases. The remote client view provided by the business interface in EJB 3.1 as described in Section 3.4 is now to be preferred.

The container provides the implementation of the remote home interface for each session bean that defines a remote home interface that is deployed in the container. The object that implements a session bean's remote home interface is called a session EJBHome object. The container makes the session bean's remote home interface available to the client through dependency injection or through lookup in the JNDI namespace.

The remote home interface allows a client to do the following:

- Create a new session object.
- Remove a session object.
- Get the `javax.ejb.EJBMetaData` interface for the session bean. The `javax.ejb.EJBMetaData` interface is intended to allow application assembly tools to discover information about the session bean, and to allow loose client/server binding and client-side scripting.
- Obtain a handle for the remote home interface. The home handle can be serialized and written to stable storage. Later, possibly in a different JVM, the handle can be deserialized from stable storage and used to obtain back a reference of the remote home interface.

The life cycle of the distributed object implementing the remote home interface (the EJBHome object) or the local Java object implementing the local home interface (the EJBLocalHome object) is container-specific. A client application should be able to obtain a home interface, and then use it multiple times, during the client application's lifetime.

A client can pass a remote home object reference to another application. The receiving application can use the home interface in the same way that it would use a remote home object reference obtained via JNDI.

3.6.2.1 Creating a Session Object

A home interface defines one or more `create<METHOD>` methods, one for each way to create a session object. The arguments of the `create` methods are typically used to initialize the state of the created session object.

The return type of a `create<METHOD>` method on the remote home interface is the session bean's remote interface.

The following example illustrates a remote home interface that defines two `create<METHOD>` methods:

```
public interface CartHome extends javax.ejb.EJBHome {
    Cart create(String customerName, String account)
        throws RemoteException, BadAccountException,
        CreateException;
    Cart createLargeCart(String customerName, String account)
        throws RemoteException, BadAccountException,
        CreateException;
}
```

The following example illustrates how a client creates a new session object using a `create<METHOD>` method of the `CartHome` interface:

```
cartHome.create("John", "7506");
```

3.6.2.2 Removing a Session Object

A remote client may remove a session object using the `remove()` method of the `javax.ejb.EJBObject` interface, or the `remove(Handle handle)` method of the `javax.ejb.EJBHome` interface.

Because session objects do not have primary keys that are accessible to clients, invoking the `javax.ejb.EJBHome.remove(Object primaryKey)` method on a session results in a `javax.ejb.RemoveException`.

3.6.3 Session Bean's Local Home Interface

This section is specific to session beans that provide a local client view using the local and local home interfaces.

This was the only way of providing a local client view in EJB 2.1 and earlier releases. The local client view provided by the business interface in EJB 3.1 as described in Section 3.4 is now to be preferred.

The container provides the implementation of the local home interface for each session bean that defines a local home interface that is deployed in the container. The object that implements a session bean's local home interface is called a session `EJBLocalHome` object. The container makes the session bean's local home interface available to the client through JNDI.

The local home interface allows a local client to do the following:

- Create a new session object.
- Remove a session object.

A client can pass a local home object reference to another application through its local interface. A local home object reference cannot be passed as an argument or result of a method on an enterprise bean's remote home or remote interface.

3.6.3.1 Creating a Session Object

A local home interface defines one or more `create<METHOD>` methods, one for each way to create a session object. The arguments of the `create` methods are typically used to initialize the state of the created session object.

The return type of a `create<METHOD>` method on the local home interface is the session bean's local interface.

The following example illustrates a local home interface that defines two `create<METHOD>` methods:

```
public interface CartHome extends javax.ejb.EJBLocalHome {
    Cart create(String customerName, String account)
        throws BadAccountException, CreateException;
    Cart createLargeCart(String customerName, String account)
        throws BadAccountException, CreateException;
}
```

The following example illustrates how a client creates a new session object using a `create<METHOD>` method of the `CartHome` interface:

```
cartHome.create("John", "7506");
```

3.6.3.2 Removing a Session Object

A local client may remove a session object using the `remove()` method of the `javax.ejb.EJBLocalObject` interface.

Because session objects do not have primary keys that are accessible to clients, invoking the `javax.ejb.EJBLocalHome.remove(Object primaryKey)` method on a session results in a `javax.ejb.RemoveException`.

3.6.4 EJBObject and EJBLocalObject

A remote or local client that uses the EJB 2.1 client view APIs uses the session bean's component interface to access a session bean instance. The class that implements the session bean's component interface is provided by the container. Instances of a session bean's remote interface are called session **EJBObjects**. Instances of a session bean's local interface are called session **EJBLocalObjects**.

A session EJBObject supports:

- The business logic methods of the object. The session EJBObject delegates invocation of a business method to the session bean instance.

- The methods of the `javax.ejb.EJBObject` interface. These methods allow the client to:
 - Get the session object's remote home interface.
 - Get the session object's handle.
 - Test if the session object is identical with another session object.
 - Remove the session object.

A session `EJBLocalObject` supports:

- The business logic methods of the object. The session `EJBLocalObject` delegates invocation of a business method to the session bean instance.
- The methods of the `javax.ejb.EJBLocalObject` interface. These methods allow the client to:
 - Get the session object's local home interface.
 - Test if the session object is identical with another session object.
 - Remove the session object.

The implementation of the methods defined in the `javax.ejb.EJBObject` and `javax.ejb.EJBLocalObject` interfaces is provided by the container. They are not delegated to the instances of the session bean class.

3.6.5 Object Identity

Session objects are intended to be private resources used only by the client that created them. For this reason, session objects, from the client's perspective, appear anonymous. In contrast to entity objects, which expose their identity as a primary key, session objects hide their identity. As a result, the `EJBObject.getPrimaryKey()` method results in a `java.rmi.RemoteException` and the `EJBLocalObject.getPrimaryKey()` method results in a `javax.ejb.EJBException`, and the `EJBHome.remove(Object primaryKey)` and the `EJBLocalHome.remove(Object primaryKey)` methods result in a `javax.ejb.RemoveException` if called on a session bean. If the `EJBMetaData.getPrimaryKeyClass()` method is invoked on a `EJBMetaData` object for a session bean, the method throws the `java.lang.RuntimeException`.

Since all session objects hide their identity, there is no need to provide a finder for them. The home interface of a session bean must not define any finder methods.

A session object handle can be held beyond the life of a client process by serializing the handle to persistent storage. When the handle is later deserialized, the session object it returns will work as long as the session object still exists on the server. (An earlier timeout or server crash may have destroyed the session object.)

A handle is not a capability, in the security sense, that would automatically grant its holder the right to invoke methods on the object. When a reference to a session object is obtained from a handle, and then a method on the session object is invoked, the container performs the usual access checks based on the caller's principal.

3.6.6 Client view of Session Object's Life Cycle

From the point of view of a local or remote client using the EJB 2.1 and earlier client view API, the life cycle of a session object is illustrated below.

Figure 3 Life Cycle of a Session Object.

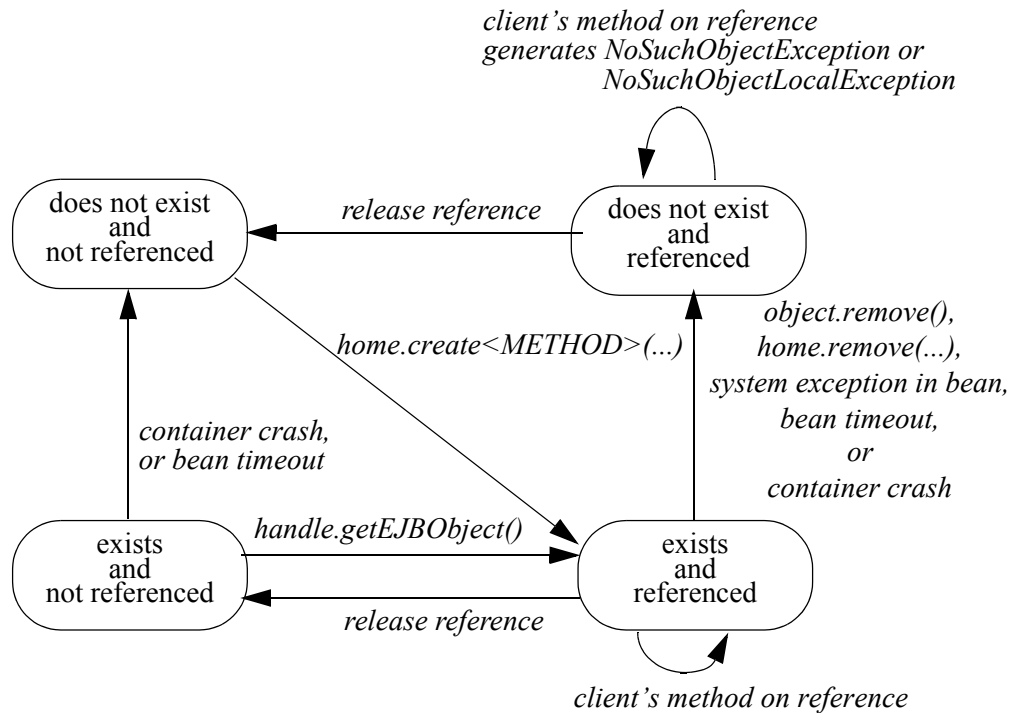

A session object does not exist until it is created. When a client creates a session object, the client has a reference to the newly created session object's component interface.

3.6.6.1 References to Session Object Remote Interfaces

A client that has a reference to a session object's remote interface can then do any of the following:

- Invoke business methods defined in the session object's remote interface.
- Get a reference to the session object's remote home interface.
- Get a handle for the session object.
- Pass the reference as a parameter or return value within the scope of the client.

- Remove the session object. A container may also remove the session object automatically when the session object's lifetime expires.

It is invalid to reference a session object that does not exist. Attempted remote invocations on a stateful session object that does not exist result in a `java.rmi.NoSuchObjectException`.^[6]

3.6.6.2 References to Session Object Local Interfaces

A client that has a reference to a session object's local interface can then do any of the following:

- Invoke business methods defined in the session object's local interface.
- Get a reference to the session object's local home interface.
- Pass the reference as a parameter or return value of a local interface method.
- Remove the session object. A container may also remove the session object automatically when the session object's lifetime expires.

It is invalid to reference a session object that does not exist. Attempted invocations on a stateful session object that does not exist result in `javax.ejb.NoSuchObjectLocalException`.^[7]

A client can pass a local object reference or local home object reference to another application through its local interface. A local object reference or local home object reference cannot be passed as an argument or result of a method on an enterprise bean's remote home or remote interface.

3.6.7 Creating and Using a Session Object

An example of the session bean runtime objects is illustrated by the following diagram:

[6] This may not apply to stateless session beans; see Section 4.7.

[7] This may not apply to stateless session beans; see Section 4.7.

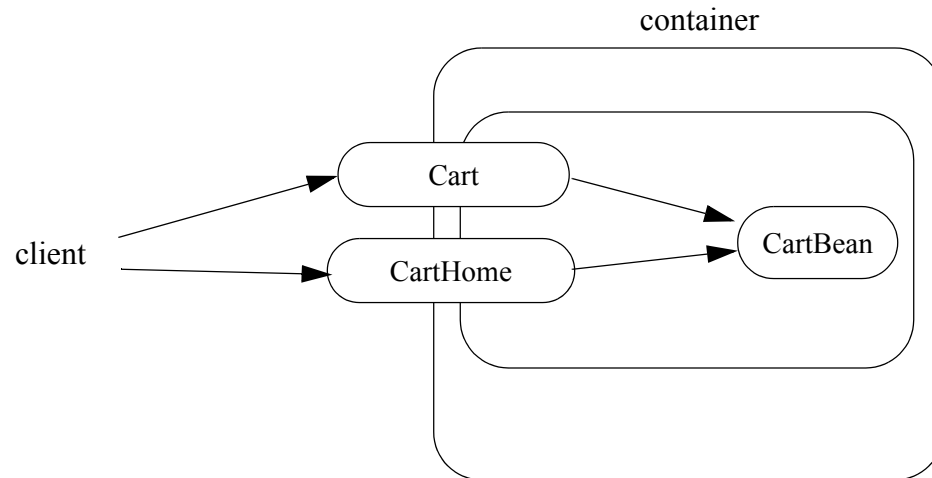
Figure 4 Session Bean Example Objects

A client creates a remote `Cart` session object, which provides a shopping service, using a `create<METHOD>` method of the `Cart`'s remote home interface. The client then uses this session object to fill the cart with items and to purchase its contents.

Suppose that the end-user wishes to start the shopping session, suspend the shopping session temporarily for a day or two, and later complete the session. The client might implement this feature by getting the session object's handle, saving the serialized handle in persistent storage, and using it later to reestablish access to the original `Cart`.

For the following example, we start by looking up the `Cart`'s remote home interface in JNDI. We then use the remote home interface to create a `Cart` session object and add a few items to it:

```

CartHome cartHome = (CartHome)jvax.rmi.PortableRemoteObject.narrow(
    initialContext.lookup(...), CartHome.class);
Cart cart = cartHome.createLargeCart(...);
cart.addItem(66);
cart.addItem(22);
  
```

Next we decide to complete this shopping session at a later time so we serialize a handle to this cart session object and store it in a file:

```

Handle cartHandle = cart.getHandle();
// serialize cartHandle, store in a file...
  
```

Finally we deserialize the handle at a later time, re-create the reference to the cart session object, and purchase the contents of the shopping cart:

```
Handle cartHandle = ...; // deserialize from a file...
Cart cart = (Cart)javax.rmi.PortableRemoteObject.narrow(
    cartHandle.getEJBObject(), Cart.class);
cart.purchase();
cart.remove();
```

3.6.8 Object Identity

3.6.8.1 Stateful Session Beans

A stateful session object has a unique identity that is assigned by the container at create time.

A remote client can determine if two remote object references refer to the same session object by invoking the `isIdentical(EJBObject otherEJBObject)` method on one of the references. A local client can determine if two local object references refer to the same session object by invoking the `isIdentical(EJBLocalObject otherEJBLocalObject)` method.

The following example illustrates the use of the `isIdentical` method for a stateful session object.

```
FooHome fooHome = ...; // obtain home of a stateful session bean
Foo foo1 = fooHome.create(...);
Foo foo2 = fooHome.create(...);

if (foo1.isIdentical(foo1)) { // this test must return true
    ...
}

if (foo1.isIdentical(foo2)) { // this test must return false
    ...
}
```

3.6.8.2 Stateless Session Beans

All session objects of the same stateless session bean within the same home have the same object identity, which is assigned by the container. If a stateless session bean is deployed multiple times (each deployment results in the creation of a distinct home), session objects from different homes will have a different identity.

The `isIdentical(EJBObject otherEJBObject)` and `isIdentical(EJBLocalObject otherEJBLocalObject)` methods always returns true when used to compare object references of two session objects of the same stateless session bean.

The following example illustrates the use of the `isIdentical` method for a stateless session object.

```
FooHome fooHome = ...; // obtain home of a stateless session bean
Foo foo1 = fooHome.create();
Foo foo2 = fooHome.create();

if (foo1.isIdentical(foo1)) { // this test returns true
    ...
}

if (foo1.isIdentical(foo2)) { // this test returns true
    ...
}
```

3.6.8.3 `getPrimaryKey()`

The object identifier of a session object is, in general, opaque to the client. The result of `getPrimaryKey()` on a session `EJBObject` reference results in `java.rmi.RemoteException`. The result of `getPrimaryKey()` on a session `EJBLocalObject` reference results in `javax.ejb.EJBException`.

3.6.9 Type Narrowing

A client program that is intended to be interoperable with all compliant EJB container implementations must use the `javax.rmi.PortableRemoteObject.narrow` method to perform type-narrowing of the client-side representations of the remote home and remote interfaces.^[8]

Note: Programs using the cast operator for narrowing the remote and remote home interfaces are likely to fail if the container implementation uses RMI-IIOP as the underlying communication transport.

[8] Use of `javax.rmi.PortableRemoteObject.narrow` is not needed when the `EJBContext` lookup method is used to look up the remote home interface.

Session Bean Component Contract

This chapter specifies the contract between a session bean and its container. It defines the life cycle of the session bean instances.

This chapter defines the developer's view of session bean state management and the container's responsibilities for managing session bean state.

4.1 Overview

A session bean instance is an instance of the session bean class. It holds the session object's state.

A session bean instance is an extension of the client that creates it:

- In the case of a stateful session bean, its fields contain a **conversational state** on behalf of the session object's client. This state describes the conversation represented by a specific client/session object pair.
- It typically reads and updates data in a database on behalf of the client.
- In the case of a stateful session bean, its lifetime is controlled by the client.

A container may also terminate a session bean instance's life after a deployer-specified timeout or as a result of the failure of the server on which the bean instance is running. For this reason, a client should be prepared to recreate a new session object if it loses the one it is using.

Typically, a session object's conversational state is not written to the database. A session bean developer simply stores it in the session bean instance's fields and assumes its value is retained for the lifetime of the instance. A developer may use an extended persistence context to store a stateful session bean's persistent conversational state. See the document "*Java Persistence API*" of this specification [2].

A session bean that does not make use of the Java Persistence API must explicitly manage cached database data. A session bean instance must write any cached database updates prior to a transaction completion, and it must refresh its copy of any potentially stale database data at the beginning of the next transaction. A session bean must also refresh any `java.sql.Statement` objects before they are used in a new transaction context. Use of the Java Persistence API provides a session bean with automatic management of database data, including the automatic flushing of cached database updates upon transaction commit. See [2].

The container manages the life cycle of the session bean instances. It notifies the instances when bean action may be necessary, and it provides a full range of services to ensure that the session bean implementation is scalable and can support a large number of clients.

A session bean can be invoked *synchronously* or *asynchronously*.

A session bean may be either:

- *stateless*—the session bean instances contain no conversational state between methods; any instance can be used for any client.
- *stateful*—the session bean instances contain conversational state which must be retained across methods and transactions.
- *singleton*—a single session bean instance is shared between clients and supports concurrent access.

4.2 Conversational State of a Stateful Session Bean

The conversational state of a *stateful* session object is defined as the session bean instance's field values, its associated interceptors and their instance field values, plus the transitive closure of the objects from these instances' fields reached by following Java object references.

To efficiently manage the size of its working set, a session bean container may need to temporarily transfer the state of an idle *stateful* session bean instance to some form of secondary storage. The transfer from the working set to secondary storage is called instance *passivation*. The transfer back is called *activation*.

In advanced cases, a session object's conversational state may contain open resources, such as open sockets and open database cursors. A container cannot retain such open resources when a session bean instance is passivated. A developer of a stateful session bean must close and open the resources in the `PrePassivate` and `PostActivate` lifecycle callback interceptor methods.^[9]

A container may only passivate a stateful session bean instance when the instance is *not* in a transaction.

A container must not passivate a stateful session bean with an extended persistence context unless the following conditions are met:^[10]

- All the entities in the persistence context are serializable.
- The `EntityManager` is serializable.

A stateless session bean is never passivated.

A singleton session bean is never passivated.

4.2.1 Instance Passivation and Conversational State

The Bean Provider is required to ensure that the `PrePassivate` method leaves the instance fields and the fields of its associated interceptors ready to be serialized by the container. The objects that are assigned to the instance's non-transient fields and the non-transient fields of its interceptors after the `PrePassivate` method completes must be one of the following.

- A serializable object^[11].
- A `null`.
- A reference to an enterprise bean's business interface.
- A reference to an enterprise bean's no-interface view.
- A reference to an enterprise bean's remote interface, even if the stub class is not serializable.
- A reference to an enterprise bean's remote home interface, even if the stub class is not serializable.
- A reference to an entity bean's local interface, even if it is not serializable.
- A reference to an entity bean's local home interface, even if it is not serializable.
- A reference to the `SessionContext` object, even if it is not serializable.

[9] Note that this requirement does not apply to the `EntityManager` and `EntityManagerFactory` objects.

[10] The container is not permitted to destroy a stateful session bean instance because it does not meet these requirements.

[11] Note that the Java Serialization protocol dynamically determines whether or not an object is serializable. This means that it is possible to serialize an object of a serializable subclass of a non-serializable declared field type.

- A reference to the environment naming context (that is, the `java:comp/env` JNDI context) or any of its subcontexts.
- A reference to the `UserTransaction` interface.
- A reference to a resource manager connection factory.
- A reference to a container-managed `EntityManager` object, even if it is not serializable.
- A reference to an `EntityManagerFactory` object obtained via injection or JNDI lookup, even if it is not serializable.
- A reference to a `javax.ejb.Timer` object.
- An object that is not directly serializable, but becomes serializable by replacing the references to an enterprise bean's business interface, an enterprise bean's home and component interfaces, the references to the `SessionContext` object, the references to the `java:comp/env` JNDI context and its subcontexts, the references to the `UserTransaction` interface, and the references to the `EntityManager` and/or `EntityManagerFactory` by serializable objects during the object's serialization.

This means, for example, that the Bean Provider must close all JDBC™ connections in the `PrePassivate` method and assign the instance's fields storing the connections to null.

The last bulleted item covers cases such as storing Collections of component interfaces in the conversational state.

The Bean Provider must assume that the content of transient fields may be lost between the `PrePassivate` and `PostActivate` notifications. Therefore, the Bean Provider should not store in a transient field a reference to any of the following objects: `SessionContext` object; environment JNDI naming context and any its subcontexts; business interfaces; home and component interfaces; `EntityManager` interface; `EntityManagerFactory` interface; `UserTransaction` interface.

The restrictions on the use of transient fields ensure that containers can use Java Serialization during passivation and activation.

The following are the requirements for the container.

The container performs the Java programming language Serialization (or its equivalent) of the instance's state (and its interceptors' state) after it invokes the `PrePassivate` method on the instance and its interceptors.

The container must be able to properly save and restore the reference to the business interfaces and home and component interfaces of the enterprise beans stored in the instance's state even if the classes that implement the object references are not serializable.

The container must be able to properly save and restore references to timers stored in the instance's state even if the classes that implement the timers are not serializable.

The container may use, for example, the object replacement technique that is part of the `java.io.ObjectOutputStream` and `java.io.ObjectInputStream` protocol to externalize the home and component references.

If the session bean instance stores in its conversational state an object reference to the `javax.ejb.SessionContext` interface, the container must be able to save and restore the reference across the instance's passivation. The container can replace the original `SessionContext` object with a different and functionally equivalent `SessionContext` object during activation.

If the session bean instance stores in its conversational state an object reference to the `java:comp/env` JNDI context or its subcontext, the container must be able to save and restore the object reference across the instance's passivation. The container can replace the original object with a different and functionally equivalent object during activation.

If the session bean instance stores in its conversational state an object reference to the `UserTransaction` interface, the container must be able to save and restore the object reference across the instance's passivation. The container can replace the original object with a different and functionally equivalent object during activation.

If the session bean instance stores in its conversational state an object reference to a container-managed `EntityManager` or to an `EntityManagerFactory` obtained via injection or JNDI lookup, the container must be able to save and restore the object reference across the instance's passivation.

The container may destroy a session bean instance if the instance does not meet the requirements for serialization after `PrePassivate`.

While the container is not required to use the Serialization protocol for the Java programming language to store the state of a passivated session instance, it must achieve the equivalent result. The one exception is that containers are not required to reset the value of `transient` fields during activation^[12]. Declaring the session bean's fields as `transient` is, in general, discouraged.

4.2.2 The Effect of Transaction Rollback on Conversational State

A session object's conversational state is not transactional. It is not automatically rolled back to its initial state if the transaction in which the object has participated rolls back.

If a rollback could result in an inconsistency between a session object's conversational state and the state of the underlying database, the bean developer (or the application development tools used by the developer) must use the `afterCompletion` notification to manually reset its state.

[12] This is to allow the container to swap out an instance's state through techniques other than the Java Serialization protocol. For example, the container's Java Virtual Machine implementation may use a block of memory to keep the instance's variables, and the container swaps the whole memory block to the disk instead of performing Java Serialization on the instance.

4.3 Protocol Between a Session Bean Instance and its Container

Containers themselves make no actual service demands on the session bean instances. The container makes calls on a bean instance to provide it with access to container services and to deliver notifications issued by the container.

4.3.1 Required Session Bean Metadata

A session bean must be annotated or denoted in the deployment descriptor as a stateless or stateful or singleton session bean. A stateless session bean must be annotated with the `Stateless` annotation or denoted in the deployment descriptor as a stateless session bean. A stateful session bean must be annotated with the `Stateful` annotation or denoted in the deployment descriptor as a stateful session bean. A singleton session bean must be annotated with the `Singleton` annotation or denoted in the deployment descriptor as a singleton session bean. The `Stateful` and `Singleton` and `Stateless` annotations are component-defining annotations and are applied to the bean class.

4.3.2 Dependency Injection

A session bean may use dependency injection mechanisms to acquire references to resources or other objects in its environment (see Chapter 16, “Enterprise Bean Environment”). If a session bean makes use of dependency injection, the container injects these references after the bean instance is created, and before any business methods are invoked on the bean instance. If a dependency on the `SessionContext` is declared, or if the bean class implements the optional `SessionBean` interface (see Section 4.3.5), the `SessionContext` is also injected at this time. If dependency injection fails, the bean instance is discarded.

Under the EJB 3.1 API, the bean class may acquire the `SessionContext` interface through dependency injection without having to implement the `SessionBean` interface. In this case, the `Resource` annotation (or `resource-env-ref` deployment descriptor element) is used to denote the bean's dependency on the `SessionContext`. See Chapter 16, “Enterprise Bean Environment”.

4.3.3 The SessionContext Interface

If the bean specifies a dependency on the `SessionContext` interface (or if the bean class implements the `SessionBean` interface), the container must provide the session bean instance with a `SessionContext`. This gives the session bean instance access to the instance's context maintained by the container. The `SessionContext` interface has the following methods:

- The `getCallerPrincipal` method returns the `java.security.Principal` that identifies the invoker.
- The `isCallerInRole` method tests if the session bean instance's caller has a particular role.

- The `setRollbackOnly` method allows the instance to mark the current transaction such that the only outcome of the transaction is a rollback. Only instances of a session bean with container-managed transaction demarcation can use this method.
- The `getRollbackOnly` method allows the instance to test if the current transaction has been marked for rollback. Only instances of a session bean with container-managed transaction demarcation can use this method.
- The `getUserTransaction` method returns the `javax.transaction.UserTransaction` interface. The instance can use this interface to demarcate transactions and to obtain transaction status. Only instances of a session bean with bean-managed transaction demarcation can use this method.
- The `getTimerService` method returns the `javax.ejb.TimerService` interface. Only stateless session beans and singleton session beans can use this method. Stateful session beans cannot be timed objects.
- The `getMessageContext` method returns the `javax.xml.rpc.handler.MessageContext` interface of a stateless session bean that implements a JAX-RPC web service endpoint. Only stateless session beans with web service endpoint interfaces can use this method.
- The `getBusinessObject(Class businessInterface)` method returns a business object reference to the session bean's business interface or no-interface view. In the case of the no-interface view, the argument is of type `<bean class>`. Only session beans with an EJB 3.x business interface or no-interface view can call this method.
- The `getInvokedBusinessInterface` method returns the session bean business interface or no-interface view(`bean class`) type through which the bean was invoked.
- The `getEJBObject` method returns the session bean's remote interface. Only session beans with a remote `EJBObject` interface can call this method.
- The `getEJBHome` method returns the session bean's remote home interface. Only session beans with a remote home interface can call this method.
- The `getEJBLocalObject` method returns the session bean's local interface. Only session beans with a local `EJBLocalObject` interface can call this method.
- The `getEJBLocalHome` method returns the session bean's local home interface. Only session beans with a local home interface can call this method.
- The `lookup` method enables the session bean to look up its environment entries in the JNDI naming context.
- The `wasCancelCalled` method enables an asynchronous session bean method to check whether the client invoked its `Future.cancel` method. `SessionContext.wasCancelCalled` only returns `true` if the `cancel` method was invoked on the client `Future` object corresponding to the currently executing business method and the `mayInterruptIfRunning` parameter was set to `true`.

- The `getContextData` method enables a business method, lifecycle callback method, or timeout method to retrieve any interceptor/webservices context associated with its invocation.

4.3.4 Session Bean Lifecycle Callback Interceptor Methods

The following lifecycle event callbacks are supported for session beans. Lifecycle callback interceptor methods may be defined directly on the bean class or on a separate interceptor class. See Section 4.9.3 and Chapter 12.

- `PostConstruct`
- `PreDestroy`
- `PostActivate`
- `PrePassivate`

The `PostConstruct` callback invocations occur before the first business method invocation on the bean. This is at a point after which any dependency injection has been performed by the container.

The `PostConstruct` lifecycle callback interceptor methods execute in an unspecified security context. The `PostConstruct` lifecycle callback interceptor methods for stateless and stateful session beans execute in an unspecified transaction context. The `PostConstruct` lifecycle callback interceptor methods for singleton beans execute in a transaction context determined by the bean's transaction management type and any applicable transaction attribute.

The `PreDestroy` callback notification signals that the instance is in the process of being removed by the container. In the `PreDestroy` lifecycle callback interceptor methods, the instance typically releases the resources that it has been holding.

The `PreDestroy` lifecycle callback interceptor methods execute in an unspecified security context. The `PreDestroy` lifecycle callback interceptor methods for stateless and stateful session beans execute in an unspecified transaction context. The `PreDestroy` lifecycle callback interceptor methods for singleton beans execute in a transaction context determined by the bean's transaction management type and any applicable transaction attribute.

The `PrePassivate` and `PostActivate` lifecycle callback interceptor methods are only called on stateful session bean instances.

The `PrePassivate` callback notification signals the intent of the container to passivate the instance. The `PostActivate` notification signals the instance it has just been reactivated. Because containers automatically maintain the conversational state of a stateful session bean instance when it is passivated, these notifications are not needed for most session beans. Their purpose is to allow stateful session beans to maintain those open resources that need to be closed prior to an instance's passivation and then reopened during an instance's activation.

The `PrePassivate` and `PostActivate` lifecycle callback interceptor methods execute in an unspecified transaction and security context.

4.3.5 The Optional SessionBean Interface

The session bean class is not required to implement the `SessionBean` interface or the `Serializable` interface. Interceptor classes for the bean are likewise not required to implement the `Serializable` interface.

Compatibility Note: The `SessionBean` interface was required to be implemented by the session bean class in earlier versions of the Enterprise JavaBeans specification. In EJB 3.x, the functionality previously provided by the `SessionBean` interface is available to the bean class through selective use of dependency injection (of the `SessionContext`) and optional lifecycle callback interceptor methods.

The `SessionBean` interface defines four methods: `setSessionContext`, `ejbRemove`, `ejbPassivate`, and `ejbActivate`.

The `setSessionContext` method is called by the bean's container to associate a session bean instance with its context maintained by the container. Typically a session bean instance retains its session context as part of its state.

The `ejbRemove` notification signals that the instance is in the process of being removed by the container. In the `ejbRemove` method, the instance typically releases the same resources that it releases in the `ejbPassivate` method.

Under the EJB 3.x API, the bean class may optionally define a `PreDestroy` lifecycle callback interceptor method for notification of the container's removal of the bean instance.

The `ejbPassivate` notification signals the intent of the container to passivate the instance. The `ejbActivate` notification signals the instance it has just been reactivated. Their purpose is to allow stateful session beans to maintain those open resources that need to be closed prior to an instance's passivation and then reopened during an instance's activation. The `ejbPassivate` and `ejbActivate` methods are only called on stateful session bean instances.

Under the EJB 3.x API, the bean class may optionally define `PrePassivate` and/or `PostActivate` lifecycle callback interceptor methods for notification of the passivation/activation of the bean instance.

This specification requires that the `ejbRemove`, `ejbActivate`, and `ejbPassivate` methods of the `SessionBean` interface, and the `ejbCreate` method of a stateless session bean be treated as `PreDestroy`, `PostActivate`, `PrePassivate` and `PostConstruct` life cycle callback interceptor methods, respectively.

If the session bean implements the `SessionBean` interface, the `PreDestroy` annotation can only be applied to the `ejbRemove` method; the `PostActivate` annotation can only be applied to the `ejbActivate` method; the `PrePassivate` annotation can only be applied to the `ejbPassivate` method. Similar requirements apply to use of deployment descriptor metadata as an alternative to the use of annotations.

4.3.6 Use of the MessageContext Interface by Session Beans

A stateless session bean that implements a web service endpoint using the JAX-RPC contracts accesses the JAX-RPC `MessageContext` interface by means of the `SessionContext.getMessageContext` method. The `MessageContext` interface allows the stateless session bean instance to see the SOAP message for the web service endpoint, as well as the properties set by the JAX-RPC SOAP message handlers, if any. The stateless session bean may use the `MessageContext` interface to set properties for the JAX-RPC message response handlers, if any.

A session bean that implements a web service endpoint using the JAX-WS contracts should use the JAX-WS `WebServiceContext`, which can be injected by use of the `Resource` annotation. The `WebServiceContext` interface allows the session bean instance to see the SOAP message for the web service endpoint, as well as the properties set by the JAX-WS message handlers, if any. The session bean may use the `WebServiceContext` interface to set properties for the JAX-WS message handlers, if any. See [32]. The JAX-WS `MessageContext` is also accessible to interceptors for session bean web service endpoints. See Section 12.6.

4.3.7 The Optional Session Synchronization Notifications for Stateful Session Beans

A stateful session bean class can optionally implement the `javax.ejb.SessionSynchronization` interface or annotate methods using the individual `@AfterBegin`, `@BeforeCompletion`, and `@AfterCompletion` annotations. The deployment descriptor may also be used to declare the individual session synchronization methods. These provide the session bean instances with transaction synchronization notifications. The instances can use these notifications, for example, to manage database data they may cache within transactions—e.g., if the Java Persistence API is not used. A stateful session bean class may use either the `javax.ejb.SessionSynchronization` interface OR the session synchronization annotations, but not both.

The `afterBegin` notification signals a session bean instance that a new transaction has begun. The container invokes this method before the first business method within a transaction (which is not necessarily at the beginning of the transaction). The `afterBegin` notification is invoked with the transaction context. The instance may do any database work it requires within the scope of the transaction.

The `beforeCompletion` notification is issued when a session bean instance's client has completed work on its current transaction but prior to committing the resource managers used by the instance. At this time, the instance should write out any database updates it has cached. The instance can cause the transaction to roll back by invoking the `setRollbackOnly` method on its session context.

The `afterCompletion` notification signals that the current transaction has completed. A completion status of `true` indicates that the transaction has committed. A status of `false` indicates that a rollback has occurred. Since a session bean instance's conversational state is not transactional, it may need to manually reset its state if a rollback occurred.

All container providers must support the session synchronization notifications. It is optional only for the bean implementor. If a bean class implements the `SessionSynchronization` interface, the container must invoke the `afterBegin`, `beforeCompletion`, and `afterCompletion` notifications as required by the specification. If the bean implementor uses the session synchronization annotations, the container must invoke only the notifications corresponding to the annotations that have been used.

A session synchronization method can have `public`, `private`, `protected`, or package level access. A session synchronization method must not be declared as `final` or `static`.

Only a stateful session bean with container-managed transaction demarcation can receive `SessionSynchronization` notifications. Stateless session beans and Singleton session beans must not implement the `SessionSynchronization` interface or use the session synchronization annotations.

There is no need for a session bean with bean-managed transaction demarcation to rely on the synchronization call backs because the bean is in control of the commit—the bean knows when the transaction is about to be committed and it knows the outcome of the transaction commit.

4.3.8 Timeout Callbacks for Stateless and Singleton Session Beans

A stateless session bean or singleton session bean can be registered with the EJB Timer Service for time-based event notifications. The container invokes the appropriate bean instance timeout callback method when a timer for the bean has expired. See Chapter 18, “Timer Service”. Stateful session beans cannot be registered with the EJB Timer Service, and therefore should not implement timeout callback methods.

4.3.9 Business Method Delegation

The session bean’s business interface, no-interface view, component interface, or web service endpoint defines the business methods callable by a client.

The container classes that implement these are generated by the container tools. The class that implements the session bean’s business interface and the class that implements the session bean’s no-interface view and the class that implements a session bean’s component interface delegate an invocation of a business method to the matching business method that is implemented in the session bean class. The class that handles requests to the web service endpoint invokes the session bean method that matches the web service method corresponding to the SOAP request.

4.3.10 Session Bean Creation

The container creates an instance of a session bean as follows. First, the container calls the bean class’s `newInstance` method to create a new session bean instance. Second, the container performs any dependency injection as specified by metadata annotations on the bean class or by the deployment descriptor. This includes the bean’s `SessionContext`, if applicable. Third, the container calls the `PostConstruct` lifecycle callback interceptor methods for the bean, if any. The additional steps described below apply if the session bean is invoked through the EJB 2.1 client view APIs.

4.3.10.1 Stateful Session Beans

If the bean is a stateful session bean and the client has used one of the `create<METHOD>` methods defined in the session bean's home or local home interface to create the bean, the container then calls the instance's initialization method whose signature matches the signature of the `create<METHOD>` invoked by the client, passing to the method the input parameters sent from the client. If the bean class was written to the EJB 3.x API, and has been adapted for use with an earlier client view, this initialization method is a matching `Init` method, as designated by use of the `Init` annotation, or `init-method` deployment descriptor element^[13]. If the bean class was written to the EJB 2.1 or earlier API, this initialization method is a matching `ejbCreate<METHOD>` method, as described in Section 4.9.5.

Each stateful session bean class that has a home interface must have at least one such initialization method. The number and signatures of a session bean's initialization methods are specific to each session bean class. Since a stateful session bean represents a specific, private conversation between the bean and its client, its initialization parameters typically contain the information the client uses to customize the bean instance for its use.

4.3.10.2 Stateless Session Beans

A stateless session bean that has an EJB 2.1 local or remote client view has a single `create` method on its home interface. In this case, EJB 2.1 required the stateless session bean class to have a single `ejbCreate` method have no arguments. Under EJB 3.1, it is not required that a stateless session bean have an `ejbCreate` method, even when it has a home interface. An EJB 3.1 stateless session bean class may have a `PostConstruct` method, as described in Section 4.3.4.

If the stateless session bean instance has an `ejbCreate` method, the container treats the `ejbCreate` method as the instance's `PostConstruct` method, and, in this case, the `PostConstruct` annotation (or deployment descriptor metadata) can only be applied to the bean's `ejbCreate` method.

Since stateless session bean instances are typically pooled, the time of the client's invocation of the `create` method need not have any direct relationship to the container's invocation of the `PostConstruct/ejbCreate` method on the stateless session bean instance.

A stateless session bean that provides only a web service client view has no `create` method. If the `ejbCreate` method required by EJB 2.1 is present, it is likewise treated by the container as the instance's `PostConstruct` method, and is invoked when the container needs to create a new session bean instance in order to service a client request.

4.3.11 Stateful Session Bean Removal

[13] Any initialization methods defined for the bean by means of the `init-method` deployment descriptor element apply in addition to those defined by means of annotations.

A stateful session bean written to the EJB 3.x API typically has one or more remove methods designated by means of the `Remove` annotation or `remove-method` deployment descriptor element.^[14] Invocation of the remove method causes the removal of the stateful session bean after the remove method successfully completes. If the `Remove` annotation specifies the value of `retainIfException` as `true`, and the `Remove` method throws an application exception, the instance is not removed. The `retain-if-exception` subelement of the `remove-method` deployment descriptor element may be explicitly specified to override the `retainIfException` value specified or defaulted by the `Remove` annotation.

4.3.12 Stateful Session Bean Timeout

A Bean Developer or Deployer may optionally assign a timeout value to a stateful session bean. This value is the amount of time a stateful session bean is permitted to remain idle (not receive any client invocations) before being removed by the container. Removal due to timeout must not occur while the bean is in the `method-ready-in-tx` state. (See stateful session bean diagram in Section 4.6)

The stateful session bean timeout is specified using the `@StatefulTimeout` annotation on the bean class. It may also be specified using the `stateful-timeout` deployment descriptor element. A timeout value of -1 indicates that the bean must not be removed due to timeout for as long as the application is deployed. A timeout value of 0 indicates that the bean is immediately eligible for removal after becoming idle.

If a stateful session bean timeout is not designated using this standard metadata, the container determines when to end the lifetime of the bean, possibly based on vendor-specific configuration. The details of such configuration are beyond the scope of the specification.

A stateful session bean instance is not eligible for timeout while it is associated with a transaction or while it is processing a business method or callback. The full stateful session bean life cycle is covered in Section 4.6.

4.3.13 Business Method Interceptor Methods for Session Beans

The `AroundInvoke` interceptor methods are supported for session beans. These interceptor methods may be defined on the bean class and/or on interceptor classes, and apply to the handling of the invocation of the business methods of the bean's business interface, no-interface view, component interface, and/or web service endpoint.

For stateful session beans that use the session synchronization notifications, `afterBegin` occurs before any `AroundInvoke` method invocation, and `beforeCompletion` after all `AroundInvoke` invocations are finished.

Interceptors are described in Chapter 12, "Interceptors".

[14] Any remove methods defined for the bean by means of the `remove-method` deployment descriptor element apply in addition to those defined by means of annotations.

4.3.14 **Serializing Session Bean Methods**

The following requirements apply to Stateless and Stateful session beans. See Section 4.8.5 for Singleton session bean concurrency requirements.

The container serializes calls to each stateful and stateless session bean instance. Most containers will support many instances of a session bean executing concurrently; however, each instance sees only a serialized sequence of method calls. Therefore, a stateful or stateless session bean does not have to be coded as reentrant.

The container must serialize all the container-invoked callbacks (that is, the business method interceptor methods, lifecycle callback interceptor methods, timeout callback methods, `beforeCompletion`, and so on), and it must serialize these callbacks with the client-invoked business method calls.

By default, clients are allowed to make concurrent calls to a stateful session object and the container is required to serialize such concurrent requests. Note that the container never permits multi-threaded access to the actual stateful session bean instance. For this reason, Read/Write method locking metadata, as well as the bean-managed concurrency mode, are not applicable to stateful session beans and must not be used. See Section 4.8.5 for a description of how these mode/locking types apply to Singleton session beans.

The Bean Developer may optionally specify that concurrent client requests to a stateful session bean are prohibited. This is done using the `@AccessTimeout` annotation or `access-timeout` deployment descriptor element with a value of 0. In this case, if a client-invoked business method is in progress on an instance when another client-invoked call, from the same or different client, arrives at the same instance of a stateful session bean, if the second client is a client of the bean's business interface or no-interface view, the concurrent invocation must result in the second client receiving a `javax.ejb.ConcurrentAccessException`^[15]. If the EJB 2.1 client view is used, the container must throw a `java.rmi.RemoteException` if the second client is a remote client, or a `javax.ejb.EJBException` if the second client is a local client.

There is no need for any restrictions against concurrent client access to stateless session beans because the container routes each request to a different instance of the stateless session bean class.

4.3.14.1 **Stateful Session Bean Concurrent Access Timeouts**

`@AccessTimeout` is used to specify the amount of time a stateful session bean request should block in the case that it can't immediately access a bean instance that is already processing a different request. If an access attempt times out, the container throws a `javax.ejb.ConcurrentAccessTimeoutException` to the client.

`@AccessTimeout` can be specified on a business method or on a bean class (or super-class). `@AccessTimeout` specified on a class applies the access timeout to all business methods of that class. If `@AccessTimeout` is specified on both a class and on a business method of that class, the method-level annotation takes precedence.

[15] The `javax.ejb.ConcurrentAccessException` is a subclass of the `javax.ejb.EJBException`. If the business interface is a remote business interface that extends `java.rmi.Remote`, the client will receive the `java.rmi.RemoteException` instead.

An `@AccessTimeout` value of -1 indicates that a concurrent client request will block indefinitely until it can proceed.

4.3.15 Transaction Context of Session Bean Methods

The implementation of a method defined in a session bean's business interface or component interface or no-interface view, a web service method, timeout callback method, or singleton `PostConstruct/PreDestroy` lifecycle callback interceptor method, is invoked in the scope of a transaction determined by the transaction attribute specified in the bean's metadata annotations or deployment descriptor.

A session bean's `afterBegin` and `beforeCompletion` methods are always called with the same transaction context as the business methods executed between the `afterBegin` and `beforeCompletion` methods.

A session bean's `newInstance`, `setSessionContext`, other dependency injection methods, life cycle callback interceptor methods, and `afterCompletion` methods are called with an unspecified transaction context. Refer to section 13.6.5 for how the container executes methods with an unspecified transaction context.

For example, it would be wrong to perform database operations within a stateful session bean's `PostConstruct` or `PreDestroy` lifecycle callback interceptor methods and to assume that the operations are part of the client's transaction. The `PostConstruct` and `PreDestroy` methods for stateful and stateless session beans are not controlled by a transaction attribute because handling roll-backs in these methods would greatly complicate the session instance's state diagram.

4.4 Global JNDI Access

The Java EE Platform Specification defines a standardized global JNDI namespace and a series of related namespaces that map to the various scopes of a Java EE application. These namespaces can be used by applications to portably retrieve references to components and resources. This specification defines the JNDI names by which session beans are required to be registered within these namespaces.

4.4.1 Syntax

Each portable session bean global JNDI name has the following syntax :

```
java:global[/<app-name>]/<module-name>/<bean-name>[!<fully-qualified-interface-name>]
```

`<app-name>` only applies if the session bean is packaged within an `.ear` file. It defaults to the base name of the `.ear` file with no filename extension, unless specified by the `application.xml` deployment descriptor.

`<module-name>` is the name of the module in which the session bean is packaged. In a stand-alone `ejb-jar` file or `.war` file, the `<module-name>` defaults to the base name of the module with any filename extension removed. In an `ear` file, the `<module-name>` defaults to the pathname of the module with any filename extension removed, but with any directory names included. The default `<module-name>` can be overridden using the `module-name` element of `ejb-jar.xml` (for `ejb-jar` files) or `web.xml` (for `.war` files).

`<bean-name>` is the `ejb-name` of the enterprise bean. For enterprise beans defined via annotation, it defaults to the *unqualified* name of the session bean class, unless specified in the contents of the `Stateless/Stateful/Singleton` annotation `name()` attribute. For enterprise beans defined via `ejb-jar.xml`, it's specified in the `<ejb-name>` deployment descriptor element.

The container registers a separate JNDI name entry for each local business interface, each remote business interface, and any no-interface view, 2.x local home interface, and 2.x remote home interface. For the no-interface view, the last portion of the entry name is the fully-qualified bean class name.

In addition to the previous requirements, if the bean exposes only one of the applicable client interfaces (or alternatively has only a no-interface view), the container registers an entry for that view with the following syntax :

```
java:global[/<app-name>]/<module-name>/<bean-name>
```

The container is also required to make session bean JNDI names available through the `java:app` and `java:module` namespaces.

4.4.1.1 **java:app**

The `java:app` prefix allows a component executing within a Java EE application to access an application-specific namespace. The resulting syntax is :

```
java:app/<module-name>/<bean-name>[!<fully-qualified-interface-name>]
```

Note that `<module-name>` is a required part of the syntax, even for names based on session bean components packaged within a stand-alone module.

4.4.1.1.1 **javax.ejb.embeddable.appName**

This property specifies an application name for the EJB modules executing within the embeddable container. If specified, the property value applies to the `<app-name>` portion of the portable global JNDI name syntax. It is recommended that this property be set whenever an embeddable container is executed with more than one `ejb` module.

The property name is defined as `javax.ejb.embeddable.EJBContainer.APP_NAME`.

See Section 22.2 for more on the embeddable API.

4.4.1.2 java:module

The `java:module` prefix allows a component executing within a Java EE application to access a module-specific namespace. The resulting syntax is :

```
java:module/<bean-name>[!<fully-qualified-interface-name>]
```

Note that the existence of global JNDI names for the Local and no-interface client views does not imply that cross-application access to those entries is required. See Section 3.2.2 for more details.

4.4.2 Examples

The following examples show the resulting global JNDI names for various session beans.

4.4.2.1 Session bean exposing a single local business interface

```
package com.acme;

@Stateless
public class FooBean implements Foo { ... }
```

If `FooBean` is packaged in `fooejb.jar` without a deployment descriptor and deployed as a stand-alone module, the resulting JNDI name entries are :

```
java:global/fooejb/FooBean
java:global/fooejb/FooBean!com.acme.Foo

java:app/fooejb/FooBean
java:app/fooejb/FooBean!com.acme.Foo

java:module/FooBean
java:module/FooBean!com.acme.Foo
```

If `FooBean` is packaged in `fooejb.jar` within `fooapp.ear`, without the use of any deployment descriptors, the resulting global JNDI name entries are :

```
java:global/fooapp/fooejb/FooBean
java:global/fooapp/fooejb/FooBean!com.acme.Foo

java:app/fooejb/FooBean
java:app/fooejb/FooBean!com.acme.Foo

java:module/FooBean
java:module/FooBean!com.acme.Foo
```

If `FooBean` is packaged in a stand-alone `.war` `fooweb.war`, without the use of any deployment descriptors, the resulting global JNDI name entries are :

```
java:global/fooweb/FooBean
java:global/fooweb/FooBean!com.acme.Foo
```

```
java:app/fooweb/FooBean
java:app/fooweb/FooBean!com.acme.Foo
```

```
java:module/FooBean
java:module/FooBean!com.acme.Foo
```

If `FooBean` is packaged in `fooweb.war` within `fooapp.ear`, without the use of any deployment descriptors, the resulting global JNDI name entries are :

```
java:global/fooapp/fooweb/FooBean
java:global/fooapp/fooweb/FooBean!com.acme.Foo
```

```
java:app/fooweb/FooBean
java:app/fooweb/FooBean!com.acme.Foo
```

```
java:module/FooBean
java:module/FooBean!com.acme.Foo
```

4.4.2.2 Session bean exposing multiple client views

```
package com.acme;

@Singleton(name="Shared")
@LocalBean
@Remote(com.acme.SharedRemote.class)
public class SharedBean { ... }
```

If `SharedBean` is packaged in `shared.jar` without a deployment descriptor and deployed as a stand-alone module, the resulting global JNDI name entries are :

```
java:global/shared/Shared!com.acme.SharedBean
java:global/shared/Shared!com.acme.SharedRemote
```

```
java:app/shared/Shared!com.acme.SharedBean
java:app/shared/Shared!com.acme.SharedRemote
```

```
java:module/Shared!com.acme.SharedBean
java:module/Shared!com.acme.SharedRemote
```

4.5 Asynchronous Methods

A session bean can expose methods with asynchronous client invocation semantics. For asynchronous invocations, control returns to the client before the container dispatches the invocation to a bean instance. An asynchronous method is a business method exposed through one or more of the Remote business, Local business, or no-interface session bean views.

Asynchronous methods can return a `Future<V>` object that allows the client to retrieve a result value, check for exceptions, or attempt to cancel an in-progress invocation.

4.5.1 Metadata

The `@Asynchronous` annotation is used to designate which business methods are asynchronous.

`@Asynchronous` can be applied to a particular business method of a bean class (or superclass), or at the class level of a bean-class (or superclass). If `@Asynchronous` is applied at the class level, all business methods declared on that specific class are asynchronous.

Asynchronous methods can also be designated via the deployment descriptor.

Asynchronous method invocation semantics only apply to the no-interface, Local business, and Remote business client views. Business methods exposed through the EJB 2.x Local, EJB 2.x Remote, and Web Service client views must not be designated as asynchronous.

4.5.2 Method Requirements

The client return type of an asynchronous method is either `void` or `java.util.concurrent.Future<V>`, where `V` is the result value type.

An asynchronous method with return type `void` must not declare any application exceptions. An asynchronous method with return type `Future<V>` is permitted to declare application exceptions.

4.5.2.1 Business Interfaces

The method signature of an asynchronous method on a business interface has return type `void` or `Future<V>`, where `V` is the result value type.

4.5.2.2 Bean Classes

The method signature of an asynchronous method on a bean-class has return type `void` or `Future<V>`, where `V` is the result value type.

The Bean Developer makes the result value of an asynchronous invocation available to the client by returning a `Future<V>` object for which both `get()` methods return the result value. A concrete `Future<V>` implementation called `javax.ejb.AsyncResult<V>` is provided by the container as a convenience. `AsyncResult<V>` has a constructor that takes the result value as a parameter.

Example :

```
@Asynchronous
public Future<Integer> performCalculation(...) {
    // ... do calculation
    Integer result = ...;
    return new AsyncResult<Integer>(result);
}
```

Note that the `Future<V>` object returned from the bean class method (including any instance of `AsyncResult<V>`) is *only* used as a way to pass the result value to the container. This object is not given directly to the caller, since by definition the caller already has a container-generated `Future<V>` object that was returned from the original EJB reference invocation.

A client can request that an asynchronous invocation be cancelled by calling the `Future<v>.cancel(boolean mayInterruptIfRunning)` method. A Bean Developer can check whether the client has requested cancellation by calling the `SessionContext.wasCancelCalled()` method within the context of the asynchronous method. See Section 3.4.8 for a complete description of the client `Future` contract.

4.5.3 Transactions

Client transaction context does not propagate with an asynchronous method invocation. From the Bean Developer's view, there is never a transaction context flowing in from the client. This means, for example, that the semantics of the `REQUIRED` transaction attribute on an asynchronous method are exactly the same as `REQUIRES_NEW`.

4.5.4 Security

Caller security principal propagates with an asynchronous method invocation. Caller security principal propagation behaves exactly the same for asynchronous method invocations as it does for synchronous session bean invocations.

4.5.5 Client Exception Behavior

Client exception behavior depends on whether the asynchronous method has return type `void` or `Future<V>`.

If the asynchronous method has return type `void`, then once control has returned from the client's method call no exceptions occurring during the processing of the invocation will be delivered to the client. For this reason, asynchronous methods with return type `void` must not declare `Application` exceptions.

If the asynchronous method has return type `Future<V>`, an exception thrown from the processing of the asynchronous method invocation is accessible to the client via the `getCause()` method of a `java.util.concurrent.ExecutionException` thrown from either `Future.get()` method.

4.6 Stateful Session Bean State Diagram

The following figure illustrates the life cycle of a stateful session bean instance.

Figure 5 Life Cycle of a Stateful Session Bean Instance

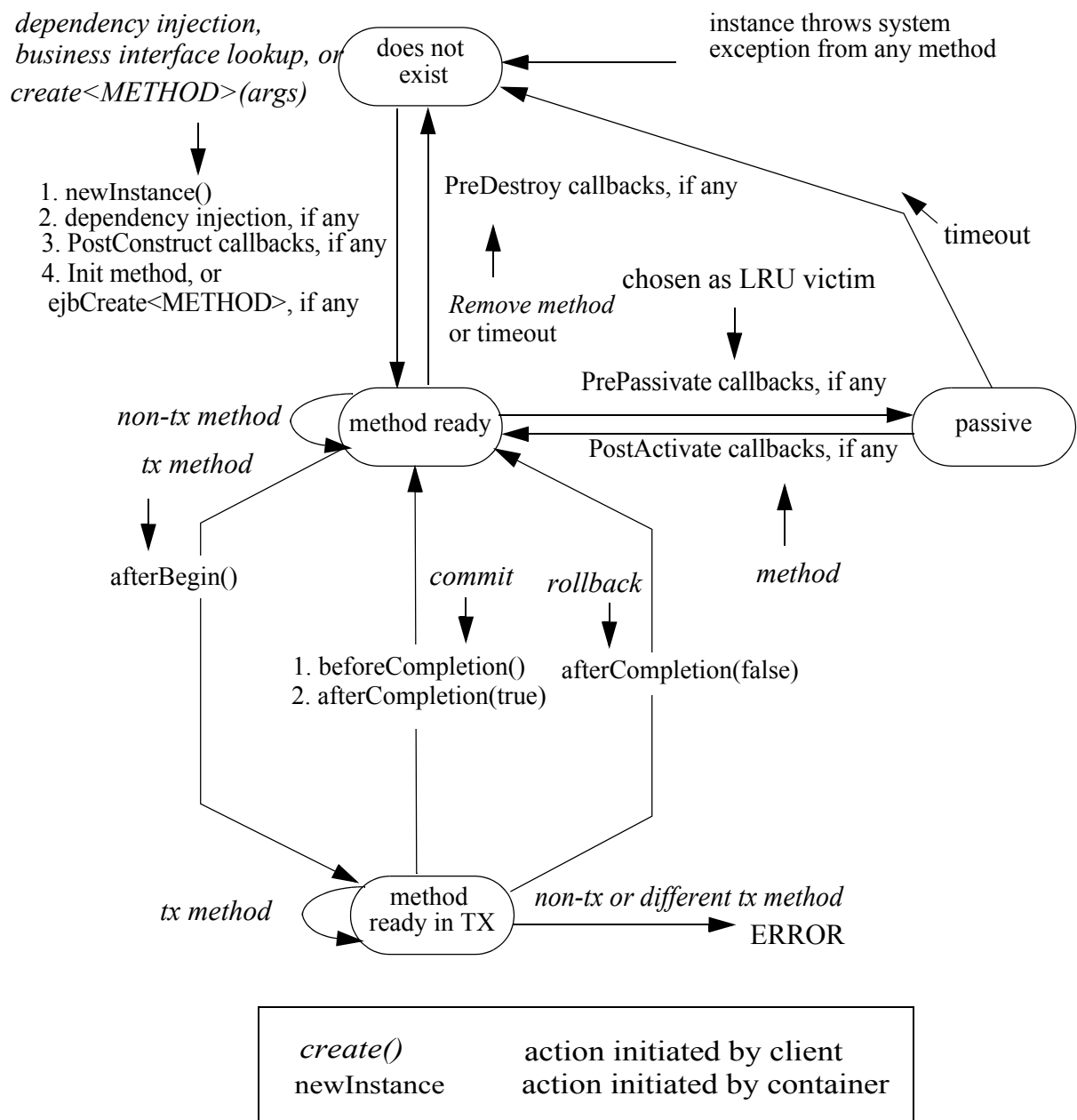

The following steps describe the life cycle of a stateful session bean instance:

- A session bean instance's life starts when a client obtains a reference to a stateful session bean instance through dependency injection or JNDI lookup, or when the client invokes a `create<METHOD>` method on the session bean's home interface. This causes the container to invoke `newInstance` on the session bean class to create a new session bean instance. Next, the container performs any dependency injection as specified by metadata annotations on the bean class or by the deployment descriptor. The container then calls the `PostConstruct` lifecycle callback interceptor method(s) for the bean, if any. Finally, if the session bean was written to the EJB 2.1 client view, the container invokes the matching `ejbCreate<METHOD>` or `Init` method on the instance. The container then returns the session object reference to the client. The instance is now in the method ready state.

NOTE: When a stateful session bean is looked up or otherwise obtained through the explicit JNDI lookup mechanisms, the container must provide a new stateful session bean instance, as required by the Java EE specification (Section "Java Naming and Directory Interface (JNDI) Naming Context" [12]).

- The session bean instance is now ready for client's business methods. Based on the transaction attributes in the session bean's metadata annotations and/or deployment descriptor and the transaction context associated with the client's invocation, a business method is executed either in a transaction context or with an unspecified transaction context (shown as "tx method" and "non-tx method" in the diagram). See Chapter 13 for how the container deals with transactions.
- A non-transactional method is executed while the instance is in the method ready state.
- An invocation of a transactional method causes the instance to be included in a transaction. When the session bean instance is included in a transaction, the container issues the `afterBegin` method on it. The `afterBegin` method is invoked on the instance before any business method or business method interceptor method is executed as part of the transaction. The instance becomes associated with the transaction and will remain associated with the transaction until the transaction completes.
- Session bean methods invoked by the client in this transaction can now be delegated to the bean instance. An error occurs if a client attempts to invoke a method on the session object and the bean's metadata annotations and/or deployment descriptor for the method requires that the container invoke the method in a different transaction context than the one with which the instance is currently associated or in an unspecified transaction context.
- If a transaction commit has been requested, the transaction service notifies the container of the commit request before actually committing the transaction, and the container issues a `beforeCompletion` on the instance. When `beforeCompletion` is invoked, the instance should write any cached updates to the database^[16]. If a transaction rollback had been requested instead, the rollback status is reached without the container issuing a `beforeCompletion`. The container may not call the `beforeCompletion` method if the transaction has been marked for rollback (nor does the instance write any cached updates to the database).

[16] Note that if the Java Persistence API is used, the persistence provider will use the `beforeCompletion` notification to automatically flush any updates to the container-managed persistence context to the database. See [2].

- The transaction service then attempts to commit the transaction, resulting in either a commit or rollback.
- When the transaction completes, the container issues `afterCompletion` on the instance, specifying the status of the completion (either commit or rollback). If a rollback occurred, the bean instance may need to reset its conversational state back to the value it had at the beginning of the transaction.
- The container's caching algorithm may decide that the bean instance should be evicted from memory. (This could be done at the end of each method, or by using an LRU policy). The container invokes the `PrePassivate` lifecycle callback interceptor method(s) for the bean instance, if any. After this completes, the container saves the instance's state to secondary storage. A session bean can be passivated only between transactions, and not within a transaction.
- While the instance is in the passivated state, the container may remove the session object after the expiration of a timeout specified by the Deployer. All object references and handles for the session object become invalid. If a client attempts to invoke a method on the bean's business interface, the container will throw the `javax.ejb.NoSuchEJBException`^[17]. If the EJB 2.1 client view is used, the container will throw the `java.rmi.NoSuchObjectException` if the client is a remote client, or the `javax.ejb.NoSuchObjectLocalException` if the client is a local client.
- If a client invokes a session object whose session bean instance has been passivated, the container will activate the instance. To activate the session bean instance, the container restores the instance's state from secondary storage and invokes the `PostActivate` method for the instance, if any.
- The session bean instance is again ready for client methods.
- When the client calls a business method of the bean that has been designated as a `Remove` method, or a `remove` method on the home or component interface, the container invokes `PreDestroy` lifecycle callback interceptor method(s) (if any) for the bean instance after the `Remove` method completes.^[18] This ends the life of the session bean instance and the associated session object. If a client subsequently attempts to invoke a method on the bean's business interface, the container will throw the `javax.ejb.NoSuchEJBException`^[19]. If the EJB 2.1 client view is used, any subsequent attempt causes the `java.rmi.NoSuchObjectException` to be thrown if the client is a remote client, or the `javax.ejb.NoSuchObjectLocalException` if the client is a local client. (The `java.rmi.NoSuchObjectException` is a subclass of the `java.rmi.RemoteException`; the `javax.ejb.NoSuchObjectLocalException` is a subclass of the `javax.ejb.EJBException`). Note that a container can also invoke the `PreDestroy` method on the instance without a client call to remove the session object after the lifetime of the EJB object has expired. If the `Remove` method completes successfully or if the `Remove`

[17] If the business interface is a remote business interface that extends `java.rmi.Remote`, the `java.rmi.NoSuchObjectException` is thrown to the client instead.

[18] If the `Remove` annotation specifies the value of `retainIfException` as `true`, and the `Remove` method throws an application exception, the instance is not removed (and the `PreDestroy` lifecycle callback interceptor methods are not invoked).

[19] If the business interface is a remote business interface that extends `java.rmi.Remote`, the `java.rmi.NoSuchObjectException` is thrown to the client instead.

methods throws an application exception for which `retainIfException` is not true or if a system exception is thrown, session synchronization methods are not called on the bean instance. If an application exception is thrown for which `retainIfException` is true, the bean is neither destroyed nor discarded, and session synchronization methods, if any, are called on the instance at the end of transaction.

The container must call the `afterBegin`, `beforeCompletion`, and `afterCompletion` methods if the session bean class implements, directly or indirectly, the `SessionSynchronization` interface, or if the bean class uses the session synchronization annotations. The container does not call these methods if the session bean class does not implement the `SessionSynchronization` interface or use the session synchronization annotations.

4.6.1 Operations Allowed in the Methods of a Stateful Session Bean Class

Table 1 defines the methods of a stateful session bean class from which the session bean instances can access the methods of the `javax.ejb.SessionContext` interface, the `java:comp/env` environment naming context, resource managers, `Timer` methods, the `EntityManager` and `EntityManagerFactory` methods, and other enterprise beans.

If a session bean instance attempts to invoke a method of the `SessionContext` interface, and that access is not allowed in Table 1, the container must throw the `java.lang.IllegalStateException`.

If a session bean instance attempts to access a resource manager, an enterprise bean, an entity manager or entity manager factory, and that access is not allowed in Table 1, the behavior is undefined by the EJB architecture.

If a session bean instance attempts to invoke a method of the `Timer` interface and the access is not allowed in Table 1, the container must throw the `java.lang.IllegalStateException`.

Table 1 Operations Allowed in the Methods of a Stateful Session Bean

Bean method	Bean method can perform the following operations	
	Container-managed transaction demarcation	Bean-managed transaction demarcation
constructor	-	-
dependency injection methods (e.g., setSessionContext)	SessionContext methods: <i>getEJBHome</i> , <i>getEJBLocalHome</i> , <i>lookup</i> JNDI access to java:comp/env	SessionContext methods: <i>getEJBHome</i> , <i>getEJBLocalHome</i> , <i>lookup</i> JNDI access to java:comp/env
PostConstruct, PreDestroy, PrePassivate, PostActivate lifecycle callback interceptor methods	SessionContext methods: <i>getBusinessObject</i> , <i>getEJBHome</i> , <i>getEJBLocalHome</i> , <i>getCallerPrincipal</i> , <i>isCallerInRole</i> , <i>getEJBObject</i> , <i>getEJBLocalObject</i> , <i>lookup</i> , <i>getContextData</i> JNDI access to java:comp/env Resource manager access Enterprise bean access EntityManagerFactory access EntityManager access	SessionContext methods: <i>getBusinessObject</i> , <i>getEJBHome</i> , <i>getEJBLocalHome</i> , <i>getCallerPrincipal</i> , <i>isCallerInRole</i> , <i>getEJBObject</i> , <i>getEJBLocalObject</i> , <i>getUserTransaction</i> , <i>lookup</i> , <i>getContextData</i> UserTransaction methods JNDI access to java:comp/env Resource manager access Enterprise bean access EntityManagerFactory access EntityManager access
business method from business interface or from no-interface view or from component interface; business method interceptor method	SessionContext methods: <i>getBusinessObject</i> , <i>getEJBHome</i> , <i>getEJBLocalHome</i> , <i>getCallerPrincipal</i> , <i>getRollbackOnly</i> , <i>isCallerInRole</i> , <i>setRollbackOnly</i> , <i>getEJBObject</i> , <i>getEJBLocalObject</i> , <i>getInvokedBusinessInterface</i> , <i>wasCancelCalled</i> , <i>lookup</i> , <i>getContextData</i> JNDI access to java:comp/env Resource manager access Enterprise bean access EntityManagerFactory access EntityManager access Timer methods	SessionContext methods: <i>getBusinessObject</i> , <i>getEJBHome</i> , <i>getEJBLocalHome</i> , <i>getCallerPrincipal</i> , <i>isCallerInRole</i> , <i>getEJBObject</i> , <i>getEJBLocalObject</i> , <i>getInvokedBusinessInterface</i> , <i>wasCancelCalled</i> , <i>lookup</i> , <i>getContextData</i> UserTransaction methods JNDI access to java:comp/env Resource manager access Enterprise bean access EntityManagerFactory access EntityManager access Timer methods

Table 1 Operations Allowed in the Methods of a Stateful Session Bean

Bean method	Bean method can perform the following operations	
	Container-managed transaction demarcation	Bean-managed transaction demarcation
afterBegin beforeCompletion	SessionContext methods: <i>getBusinessObject</i> , <i>getJBHome</i> , <i>getJBLocalHome</i> , <i>getCallerPrincipal</i> , <i>getRollbackOnly</i> , <i>isCallerInRole</i> , <i>setRollbackOnly</i> , <i>getEJBObject</i> , <i>getJBLocalObject</i> , <i>lookup</i> , <i>getContextData</i> JNDI access to java:comp/env Resource manager access Enterprise bean access EntityManagerFactory access EntityManager access Timer methods	N/A (a bean with bean-managed transaction demarcation cannot implement the SessionSynchronization interface or use the session synchronization annotations)
afterCompletion	SessionContext methods: <i>getBusinessObject</i> , <i>getJBHome</i> , <i>getJBLocalHome</i> , <i>getCallerPrincipal</i> , <i>isCallerInRole</i> , <i>getEJBObject</i> , <i>getJBLocalObject</i> , <i>lookup</i> , <i>getContextData</i> JNDI access to java:comp/env	

Notes:

- The `PostConstruct`, `PreDestroy`, `PrePassivate`, `PostActivate`, `Init`, and/or `ejbCreate<METHOD>`, `ejbRemove`, `ejbPassivate`, and `ejbActivate` methods of a session bean with container-managed transaction demarcation execute with an unspecified transaction context. Refer to Subsection 13.6.5 for how the container executes methods with an unspecified transaction context.
- In some cases, lifecycle callback interceptor methods initiated solely by the container without an associated client invocation run in an unspecified security context. E.g., a `@PostConstruct` method callback invoked as a side-effect of injection of an EJB 3.x remote or local business interface reference. However, the container is still required to permit calls to these methods according to the rules in this table.

Additional restrictions:

- The `getRollbackOnly` and `setRollbackOnly` methods of the `SessionContext` interface should be used only in the session bean methods that execute in the context of a transaction. The container must throw the `java.lang.IllegalStateException` if the methods are invoked while the instance is not associated with a transaction.

The reasons for disallowing the operations in Table 1 follow:

- Invoking the `getBusinessObject` method is disallowed if the session bean does not define an EJB 3.x business interface and does not define a no-interface view.
- Invoking the `getInvokedBusinessInterface` method is disallowed if the session bean does not define an EJB 3.x business interface and does not define a no-interface view. It is also disallowed if the current business method was not invoked through a business interface or the no-interface view.
- Invoking the `getEJBObject` and `getEJBHome` methods is disallowed if the session bean does not define a remote client view.
- Invoking the `getEJBLocalObject` and `getEJBLocalHome` methods is disallowed if the session bean does not define a local client view.
- Invoking the `getRollbackOnly` and `setRollbackOnly` methods is disallowed in the session bean methods for which the container does not have a meaningful transaction context, and to all session beans with bean-managed transaction demarcation.
- Accessing resource managers and enterprise beans is disallowed in the session bean methods for which the container does not have a meaningful transaction context and/or client security context.
- The `UserTransaction` interface is unavailable to enterprise beans with container-managed transaction demarcation.
- The `TimerService` interface is unavailable to stateful session beans.
- Invoking the `getMessageContext` method is disallowed for stateful session beans.
- Invoking the `getEJBObject` and `getEJBLocalObject` methods is disallowed in the session bean methods in which there is no session object identity established for the instance.

4.6.2 Dealing with Exceptions

A `RuntimeException` that is not an application exception thrown from any method of the session bean class (including the business methods and the lifecycle callback interceptor methods invoked by the container) results in the transition to the “does not exist” state. Exception handling is described in detail in Chapter 14. See section 12.5.1 for the rules pertaining to lifecycle callback interceptor methods when more than one such method applies to the bean class.

From the client perspective, the corresponding session object does not exist any more. If a client subsequently attempts to invoke a method on the bean's business interface or the no-interface view, the container will throw the `javax.ejb.NoSuchEJBException`^[20]. If the EJB 2.1 client view is used, the container will throw the `java.rmi.NoSuchObjectException` if the client is a remote client, or the `javax.ejb.NoSuchObjectLocalException` if the client is a local client.

4.6.3 Missed PreDestroy Calls

The Bean Provider cannot assume that the container will always invoke the `PreDestroy` lifecycle callback interceptor method(s) (or `ejbRemove` method) for a session bean instance. The following scenarios result in the `PreDestroy` lifecycle callback interceptor method(s) not being called for an instance:

- A crash of the EJB container.
- A system exception thrown from the instance's method to the container.
- A timeout of client inactivity while the instance is in the `passive` state. The timeout is specified by the Deployer in an EJB container implementation-specific way.

If resources are allocated in a `PostConstruct` lifecycle callback interceptor method (or `ejbCreate<METHOD>` method) and/or in the business methods, and normally released in a `PreDestroy` lifecycle callback interceptor method, these resources will not be automatically released in the above scenarios. The application using the session bean should provide some clean up mechanism to periodically clean up the unreleased resources.

For example, if a shopping cart component is implemented as a session bean, and the session bean stores the shopping cart content in a database, the application should provide a program that runs periodically and removes "abandoned" shopping carts from the database.

4.6.4 Restrictions for Transactions

The state diagram implies the following restrictions on transaction scoping of the client invoked business methods. The restrictions are enforced by the container and must be observed by the client programmer.

- A session bean instance can participate in at most a single transaction at a time.
- If a session bean instance is participating in a transaction, it is an error for a client to invoke a method on the session object such that the transaction attribute specified in the bean's metadata annotations and/or the deployment descriptor would cause the container to execute the method in a different transaction context or in an unspecified transaction context. In such a case, the `javax.ejb.EJBException` will be thrown to a client of the bean's business interface^[21].

[20] If the business interface is a remote business interface that extends `java.rmi.Remote`, the `java.rmi.NoSuchObjectException` is thrown to the client instead.

[21] If the business interface is a remote business interface that extends `java.rmi.Remote`, the `java.rmi.RemoteException` is thrown to the client instead.

If the EJB 2.1 client view is used, the container throws the `java.rmi.RemoteException` to the client if the client is a remote client, or the `javax.ejb.EJBException` if the client is a local client.

- If a session bean instance is participating in a transaction, it is an error for a client to invoke the `remove` method on the session object's home or component interface object. The container must detect such an attempt and throw the `javax.ejb.RemoveException` to the client. The container should not mark the client's transaction for rollback, thus allowing the client to recover. Note that this restriction only applies to the `remove` method on the session object's home or component interface, not to the invocation of `@Remove` methods.

4.7 Stateless Session Beans

Stateless session beans are session beans whose instances have no conversational state. This means that all bean instances are equivalent when they are not involved in servicing a client-invoked method.

The term “stateless” signifies that an instance has no state for a specific client. However, the instance variables of the instance can contain the state across client-invoked method calls. Examples of such state include an open database connection and an object reference to an enterprise bean object.

The Bean Provider must exercise caution if retaining any application state across method calls. In particular, references to common bean state should not be returned through multiple local interface method calls.

Because all instances of a stateless session bean are equivalent, the container can choose to delegate a client-invoked method to any available instance. This means, for example, that the container may delegate the requests from the same client within the same transaction to different instances, and that the container may interleave requests from multiple transactions to the same instance.

A container only needs to retain the number of instances required to service the current client load. Due to client “think time,” this number is typically much smaller than the number of active clients. Passivation is not needed or used for stateless sessions. The container creates another stateless session bean instance if one is needed to handle an increase in client work load. If a stateless session bean is not needed to handle the current client work load, the container can destroy it.

Because stateless session beans minimize the resources needed to support a large population of clients, depending on the implementation of the container, applications that use stateless session beans may scale somewhat better than those using stateful session beans. However, this benefit may be offset by the increased complexity of the client application that uses the stateless beans.

Compatibility Note: Local and remote clients using the EJB 2.1 client view interfaces use the `create` and `remove` methods on the home interface of a stateless session bean in the same way as on a stateful session bean. To the EJB 2.1 client, it appears as if the client controls the life cycle of the session object. However, the container handles the `create` and `remove` calls without necessarily creating and removing an EJB instance. The home interface of a stateless session bean must have one `create` method that takes no arguments. The `create` method of the remote home interface must return the session bean's remote interface. The `create` method of the local home interface must return the session bean's local interface. There can be no other `create` methods in the home interface.

There is no fixed mapping between clients and stateless instances. The container simply delegates a client's work to any available instance that is method-ready.

A stateless session bean must not implement the `javax.ejb.SessionSynchronization` interface or use the session synchronization annotations.

4.7.1 Stateless Session Bean State Diagram

When a client calls a method on a stateless session object or invokes a method on a stateless session bean through its web service client view, the container selects one of its method-ready instances and delegates the method invocation to it.

The following figure illustrates the life cycle of a *stateless* session bean instance.

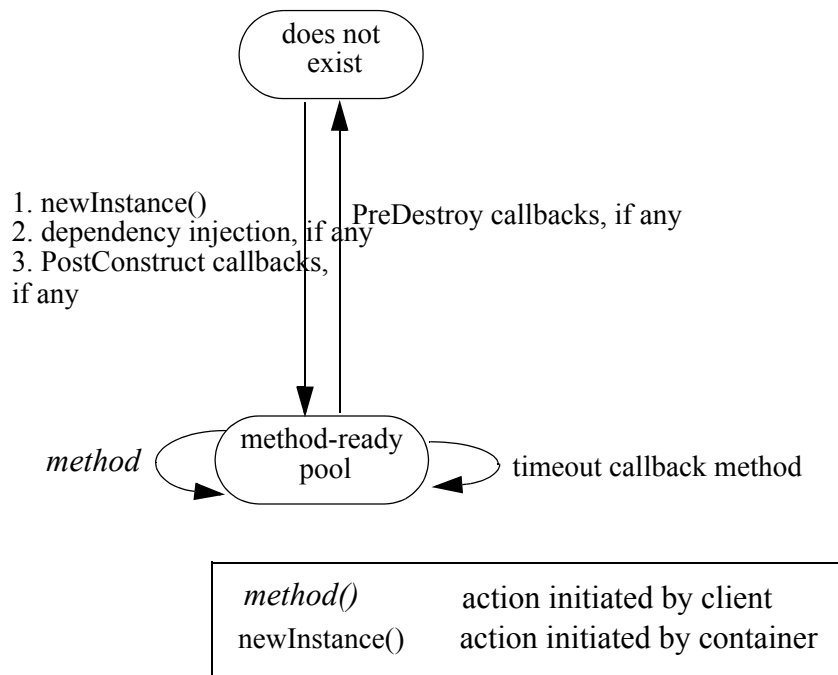
Figure 6 Life Cycle of a Stateless Session Bean

The following steps describe the life cycle of a session bean instance:

- A stateless session bean instance's life starts when the container invokes the `newInstance` method on the session bean class to create a new session bean instance. Next, the container performs any dependency injection as specified by metadata annotations on the bean class or by the deployment descriptor. The container then calls the `PostConstruct` lifecycle callback interceptor methods for the bean, if any. The container can perform the instance creation at any time—there is no direct relationship to a client's invocation of a business method or the `create` method.
- The session bean instance is now ready to be delegated a business method call from any client or a call from the container to a timeout callback method.
- When the container no longer needs the instance (usually when the container wants to reduce the number of instances in the method-ready pool), the container invokes the `PreDestroy` lifecycle callback interceptor methods for it, if any. This ends the life of the stateless session bean instance.

4.7.2 Operations Allowed in the Methods of a Stateless Session Bean Class

Table 2 defines the methods of a stateless session bean class in which the session bean instances can access the methods of the `javax.ejb.SessionContext` interface, the `java:comp/env` environment naming context, resource managers, `TimerService` and `Timer` methods, the `EntityManager` and `EntityManagerFactory` methods, and other enterprise beans.

If a session bean instance attempts to invoke a method of the `SessionContext` interface, and the access is not allowed in Table 2, the container must throw the `java.lang.IllegalStateException`.

If a session bean instance attempts to invoke a method of the `TimerService` or `Timer` interface and the access is not allowed in Table 2, the container must throw the `java.lang.IllegalStateException`.

If a session bean instance attempts to access a resource manager, an enterprise bean, an entity manager or entity manager factory, and the access is not allowed in Table 2, the behavior is undefined by the EJB architecture.

Table 2 Operations Allowed in the Methods of a Stateless Session Bean

Bean method	Bean method can perform the following operations	
	Container-managed transaction demarcation	Bean-managed transaction demarcation
constructor	-	-
dependency injection methods (e.g., setSessionContext)	SessionContext methods: <i>getEJBHome</i> , <i>getEJBLocalHome</i> , <i>lookup</i> JNDI access to java:comp/env	SessionContext methods: <i>getEJBHome</i> , <i>getEJBLocalHome</i> , <i>lookup</i> JNDI access to java:comp/env
PostConstruct, Pre-Destroy lifecycle callback interceptor methods	SessionContext methods: <i>getBusinessObject</i> , <i>getEJBHome</i> , <i>getEJBLocalHome</i> , <i>getEJBObject</i> , <i>getEJBLocalObject</i> , <i>getTimerService</i> , <i>lookup</i> , <i>getContextData</i> JNDI access to java:comp/env EntityManagerFactory access	SessionContext methods: <i>getBusinessObject</i> , <i>getEJBHome</i> , <i>getEJBLocalHome</i> , <i>getEJBObject</i> , <i>getEJBLocalObject</i> , <i>getUserTransaction</i> , <i>getTimerService</i> , <i>lookup</i> , <i>getContextData</i> JNDI access to java:comp/env EntityManagerFactory access
business method from business interface or from no-interface view or from component interface; business method interceptor method	SessionContext methods: <i>getBusinessObject</i> , <i>getEJBHome</i> , <i>getEJBLocalHome</i> , <i>getCallerPrincipal</i> , <i>isCallerInRole</i> , <i>getRollbackOnly</i> , <i>setRollbackOnly</i> , <i>getEJBObject</i> , <i>getEJBLocalObject</i> , <i>getTimerService</i> , <i>getInvokedBusinessInterface</i> , <i>wasCancelCalled</i> , <i>lookup</i> , <i>getContextData</i> JNDI access to java:comp/env Resource manager access Enterprise bean access EntityManagerFactory access EntityManager access TimerService and Timer methods	SessionContext methods: <i>getBusinessObject</i> , <i>getEJBHome</i> , <i>getEJBLocalHome</i> , <i>getCallerPrincipal</i> , <i>isCallerInRole</i> , <i>getEJBObject</i> , <i>getEJBLocalObject</i> , <i>getUserTransaction</i> , <i>getTimerService</i> , <i>getInvokedBusinessInterface</i> , <i>wasCancelCalled</i> , <i>lookup</i> , <i>getContextData</i> UserTransaction methods JNDI access to java:comp/env Resource manager access Enterprise bean access EntityManagerFactory access EntityManager access TimerService and Timer methods

Table 2 Operations Allowed in the Methods of a Stateless Session Bean

Bean method	Bean method can perform the following operations	
	Container-managed transaction demarcation	Bean-managed transaction demarcation
business method from web service endpoint	SessionContext methods: <i>getBusinessObject</i> , <i>getEJBHome</i> , <i>getEJBLocalHome</i> , <i>getCallerPrincipal</i> , <i>isCallerInRole</i> , <i>getRollbackOnly</i> , <i>setRollbackOnly</i> , <i>getEJBObject</i> , <i>getEJBLocalObject</i> , <i>getTimerService</i> , <i>getMessageContext</i> , <i>lookup</i> , <i>getContextData</i> Message context methods JNDI access to java:comp/env Resource manager access Enterprise bean access EntityManagerFactory access EntityManager access TimerService and Timer methods	SessionContext methods: <i>getBusinessObject</i> , <i>getEJBHome</i> , <i>getEJBLocalHome</i> , <i>getCallerPrincipal</i> , <i>isCallerInRole</i> , <i>getEJBObject</i> , <i>getEJBLocalObject</i> , <i>getUserTransaction</i> , <i>getTimerService</i> , <i>getMessageContext</i> , <i>lookup</i> , <i>getContextData</i> UserTransaction methods Message context methods JNDI access to java:comp/env Resource manager access Enterprise bean access EntityManagerFactory access EntityManager access TimerService and Timer methods
timeout callback method	SessionContext methods: <i>getBusinessObject</i> , <i>getEJBHome</i> , <i>getEJBLocalHome</i> , <i>getCallerPrincipal</i> , <i>isCallerInRole</i> , <i>getRollbackOnly</i> , <i>setRollbackOnly</i> , <i>getEJBObject</i> , <i>getEJBLocalObject</i> , <i>getTimerService</i> , <i>lookup</i> , <i>getContextData</i> JNDI access to java:comp/env Resource manager access Enterprise bean access EntityManagerFactory access EntityManager access TimerService and Timer methods	SessionContext methods: <i>getBusinessObject</i> , <i>getEJBHome</i> , <i>getEJBLocalHome</i> , <i>getCallerPrincipal</i> , <i>isCallerInRole</i> , <i>getEJBObject</i> , <i>getEJBLocalObject</i> , <i>getTimerService</i> , <i>lookup</i> , <i>getContextData</i> UserTransaction methods JNDI access to java:comp/env Resource manager access Enterprise bean access EntityManagerFactory access EntityManager access TimerService and Timer methods

Additional restrictions:

- The `getRollbackOnly` and `setRollbackOnly` methods of the `SessionContext` interface should be used only in the session bean methods that execute in the context of a transaction. The container must throw the `java.lang.IllegalStateException` if the methods are invoked while the instance is not associated with a transaction.

The reasons for disallowing operations in Table 2:

- Invoking the `getBusinessObject` method is disallowed if the session bean does not define an EJB 3.x business interface and does not define a no-interface view.
- Invoking the `getInvokedBusinessInterface` method is disallowed if the session bean does not define an EJB 3.x business interface and does not define a no-interface view. It is also disallowed if the current business method was not invoked through a business interface or the no-interface view.
- Invoking the `getEJBObject` and `getEJBHome` methods is disallowed if the session bean does not define a remote client view.
- Invoking the `getEJBLocalObject` and `getEJBLocalHome` methods is disallowed if the session bean does not define a local client view.
- Invoking the `getRollbackOnly` and `setRollbackOnly` methods is disallowed in the session bean methods for which the container does not have a meaningful transaction context, and for all session beans with bean-managed transaction demarcation.
- Invoking the `getMessageContext` method is disallowed in session bean methods that were not invoked by the container through the session bean's web service endpoint. The `getMessageContext` method returns the `javax.xml.rpc.handler.MessageContext` interface of a stateless session bean that implements a JAX-RPC web service endpoint.
- Accessing resource managers, enterprise beans, and the `EntityManager` is disallowed in the session bean methods for which the container does not have a meaningful transaction context and/or client security context.
- The `UserTransaction` interface is unavailable to session beans with container-managed transaction demarcation.

4.7.3 Dealing with Exceptions

A `RuntimeException` that is not an application exception thrown from any method of the enterprise bean class (including the business methods and the lifecycle callback interceptor methods invoked by the container) results in the transition to the “does not exist” state. Exception handling is described in detail in Chapter 14. See section 12.5.1 for the rules pertaining to lifecycle callback interceptor methods when more than one such method applies to the bean class.

From the client perspective, the session object continues to exist. The client can continue accessing the session object because the container can delegate the client's requests to another instance.

4.8 Singleton Session Beans

A Singleton session bean is a session bean component that is instantiated once per application. In cases where the container is distributed over many virtual machines, each application will have one bean instance of the Singleton for each JVM.

Once instantiated, a Singleton session bean instance lives for the duration of the application in which it is created. It maintains its state between client invocations but that state is not required to survive container shutdown or crash.

A Singleton session bean is intended to be shared and supports concurrent access.

A Singleton session bean must not implement the `javax.ejb.SessionSynchronization` interface or use the session synchronization annotations.

Figure 7 Life Cycle of a Singleton Session Bean

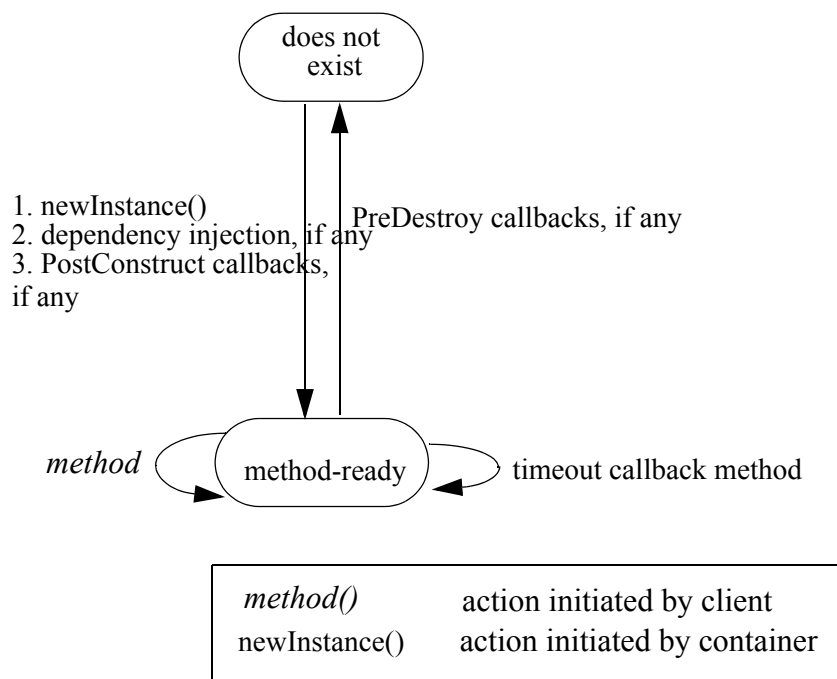

The following steps describe the life cycle of a singleton session bean instance:

- A singleton session bean instance's life starts when the container invokes the `newInstance` method on the session bean class to create the singleton bean instance. Next, the container per-

forms any dependency injection as specified by the metadata annotations on the bean class or by the deployment descriptor. The container then calls the `PostConstruct` lifecycle callback interceptor methods for the bean, if any.

- The singleton bean instance is now ready to be delegated a business method call from any client or a call from the container to a timeout callback method.
- When the application is shutting down, the container invokes the `PreDestroy` lifecycle callback interceptor methods on the singleton, if any. This ends the life of the singleton session bean instance.

4.8.1 Singleton Initialization

By default, the container is responsible for deciding *when* to initialize a Singleton bean instance. However, the bean developer can optionally configure the Singleton for eager initialization. If the `Startup` annotation appears on the Singleton bean class or if the Singleton has been designated via the deployment descriptor as requiring eager initialization, the container must initialize the Singleton bean instance during the application startup sequence. The container must initialize all such startup-time Singletons before any external client requests (that is, client requests originating outside of the application) are delivered to any enterprise bean components in the application.

The following example shows a Singleton with startup logic that initializes its shared state :

```
@Startup
@Singleton
public class SharedBean implements Shared {

    private SharedData state;

    @PostConstruct
    void init() {
        // initialize shared data
        ...
    }
    ...
}
```

In some cases, explicit initialization ordering dependencies exist between multiple Singleton components in an application. The `DependsOn` annotation is used to express these dependencies. A `DependsOn` dependency is used in cases where one Singleton must *initialize* before one or more other Singletons. The container ensures that all Singleton beans with which a Singleton has a `DependsOn` relationship have been initialized before `PostConstruct` is called.

Note that if one Singleton merely needs to invoke another Singleton from its `PostConstruct` method, no explicit ordering metadata is required. In that case, the first Singleton would merely use an `ejb` reference to invoke the target Singleton. There, the acquisition of the `ejb` reference (either through injection or lookup) does not necessarily imply the actual creation of the corresponding Singleton bean instance.

The following examples illustrate the use of `DependsOn` metadata :

```
@Singleton
public class B { ... }

@DependsOn("B")
@Singleton
public class A { ... }
```

This tells the container to guarantee that Singleton B is initialized before Singleton A. The `DependsOn` value attribute holds one or more strings, where each specifies the `ejb-name` of the target Singleton using the same syntax as the `@EJB beanName()` attribute.

```
@Singleton
public class B { ... }

@Singleton
public class C { ... }

@DependsOn({"B", "C"})
@Singleton
public class A { ... }
```

This tells the container to guarantee that Singletons B and C are initialized before Singleton A. In the case of multiple values, the ordering in which the target `ejb-names` are listed is not preserved at runtime. E.g., if Singleton B has an ordering dependency on Singleton C, it is Singleton B's responsibility to explicitly capture that in its own metadata.

```
// two Singleton components packaged in different ejb-jars within
// the same .ear

// packaged in b.jar
@Singleton
public class B { ... }

// packaged in a.jar
@DependsOn("b.jar#B")
@Singleton
public class A { ... }
```

This shows the use of the fully-qualified `ejb-name` syntax to refer to a Singleton component packaged within a different module in the same application.

Circular dependencies within `DependsOn` metadata are not permitted. Circular dependencies are not required to be detected by the container but may result in a deployment error.

4.8.2 Singleton Destruction

Any Singleton instance that successfully completes initialization is explicitly removed by the container during application shutdown. At this time the container invokes the `PreDestroy` lifecycle callback interceptor methods on the singleton, if any. The container ensures that all singleton beans with which a Singleton has a `DependsOn` relationship are still available during `PreDestroy`. After `PreDestroy` completes the container ends the life of the singleton bean instance.

4.8.3 Transaction Semantics of Initialization and Destruction

`PostConstruct` and `PreDestroy` methods of Singletons with container-managed transactions are transactional. From the bean developer's view there is no client of a `PostConstruct` or `PreDestroy` method.

A `PostConstruct` or `PreDestroy` method of a Singleton with container-managed transactions has transaction attribute `REQUIRED`, `REQUIRES_NEW`, or `NOT_SUPPORTED` (`Required`, `RequiresNew`, or `NotSupported` if the deployment descriptor is used to specify the transaction attribute).

Note that the container must start a new transaction if the `REQUIRED` (`Required`) transaction attribute is used. This guarantees, for example, that the transactional behavior of the `PostConstruct` method is the same regardless of whether it is initialized eagerly at container startup time or as a side effect of a first client invocation on the Singleton. The `REQUIRED` transaction attribute value is allowed so that specification of a transaction attribute for the Singleton `PostConstruct/PreDestroy` methods can be defaulted.

4.8.4 Singleton Error Handling

Errors occurring during Singleton initialization are considered fatal and must result in the discarding of the Singleton instance. Possible initialization errors include injection failure, a system exception thrown from a `PostConstruct` method, or the failure of a `PostConstruct` method container-managed transaction to successfully commit. If a singleton fails to initialize, attempted invocations on the Singleton result in an exception as defined by Section 3.4.3 and Section 3.4.4.

The same Singleton bean instance must remain active until application shutdown. Unlike instances of other component types, system exceptions thrown from business methods or callbacks of a Singleton do *not* result in the destruction of the Singleton instance.

4.8.5 Singleton Concurrency

From the client's perspective, a Singleton bean always supports concurrent access. In general, a Singleton client does not have to concern itself with whether other clients might be accessing the Singleton at the same time.

From the bean developer's perspective, there are two approaches for controlling Singleton concurrency behavior :

- container-managed concurrency : the container controls concurrent access to the bean instance based on method-level locking metadata

- bean-managed concurrency : the container allows full concurrent bean instance access and defers state synchronization responsibility to the bean developer

When designing a Singleton session bean, the developer must decide whether the bean will use container managed or bean managed concurrency. Typically Singleton beans will be specified to have container managed concurrency demarcation. This is the default if no concurrency management type is specified. A Singleton bean can be designed to use either container managed concurrency or bean managed concurrency but it cannot use both.

The lifecycle of any interceptor classes associated with a Singleton have the same lifecycle and concurrency behavior as that Singleton. Each interceptor class will be instantiated once per Singleton bean instance. Any state stored in an instance of an interceptor class associated with a Singleton should be considered when devising the concurrency plan for the bean.

It is legal to store Java EE objects that do not support concurrent access (e.g. Entity Managers, Stateful Session Bean references) within Singleton bean instance state. However, it is the responsibility of the Bean Developer to ensure such objects are not accessed by more than one thread at a time.

Independent of the bean's concurrency management type, the container must ensure that no concurrent access to the Singleton bean instance occurs until after the instance has successfully completed its initialization sequence, including any `@PostConstruct` lifecycle callback method(s). The container must temporarily block any Singleton access attempts that arrive while the Singleton is still initializing.

Singleton beans support reentrant calls. That is, where an outbound call from a Singleton method results in a loopback call to the Singleton on the same thread. Reentrant Singletons should be programmed and used with caution. Special locking semantics apply to loopback calls on Singletons with container-managed concurrency (detailed below).

4.8.5.1 Container Managed Concurrency

With Container Managed Concurrency demarcation, the container is responsible for controlling concurrent access to the bean instance based on method-level locking metadata. Each business method or timeout method is associated with either a `Read`(shared) lock or `Write` (exclusive) lock.

If the container invokes a method associated with a `Read` lock, any number of other concurrent invocations on `Read` methods are allowed to access the bean instance simultaneously.

If the container invokes a method associated with a `Write` lock, no other concurrent invocations will be allowed to proceed until the initial `Write` method's processing completes.

A concurrent access attempt that is not allowed to proceed due to locking is blocked until it can make forward progress. Timeouts can be specified via metadata so that a blocked request can be rejected if a lock is not acquired within a certain amount of time. If a Singleton invocation is rejected due to lock timeout the `ConcurrentAccessTimeoutException` is thrown to the client.

This specification only mandates the basic `Read/Write` locking semantics outlined above. There are many policy decisions that a container could make to affect the performance of the locking scheme for a given application. For example :

- Determining whether to grant forward progress to a `Read` method or `Write` method, when both readers and writers are waiting, at the time that a write method completes.
- Determining whether to allow additional readers while one or more readers is active and a writer is waiting.

The exact set of additional read/write locking policy decisions supported by a container provider and the configuration requirements for those policies are outside the scope of this specification.

4.8.5.1.1 Reentrant Locking Behavior

Special locking semantics apply to loopback calls on Singletons with container-managed concurrency.

If a loopback call occurs on a Singleton that already holds a `Write` lock on the same thread :

- If the target of the loopback call is a `Read` method, the `Read` lock must always be granted immediately, without releasing the original `Write` lock.
- If the target of the loopback call is a `Write` method, the call must proceed immediately, without releasing the original `Write` lock.

If a loopback call occurs on a Singleton that holds a `Read` lock on the same thread (but does not also hold a `Write` lock on the same thread) :

- If the target of the loopback call is a `Read` method, the call must proceed immediately, without releasing the original `Read` lock.
- If the target of the loopback call is a `Write` method, a `javax.ejb.IllegalLoopbackException` must be thrown to the caller.

4.8.5.2 Bean Managed Concurrency

With Bean Managed Concurrency demarcation, the container allows full concurrent access to the Singleton bean instance. It is the responsibility of the bean developer to guard its state as necessary against synchronization errors due to concurrent access. The bean developer is permitted to use the Java language level synchronization primitives such as `synchronized` and `volatile` for this purpose.

4.8.5.3 Specification of a Concurrency Management Type

By default, a singleton bean has container managed concurrency demarcation if the concurrency management type is not specified. The Bean Provider of a singleton bean can use the `ConcurrencyManagement` annotation on the bean class to declare the bean's concurrency management type.

Alternatively, the Bean Provider can use the deployment descriptor to specify the bean's concurrency management type. If the deployment descriptor is used, it is only necessary to explicitly specify the bean's concurrency management type if bean managed concurrency is used.

The concurrency management type of a Singleton is determined by the Bean Provider. The application assembler is not permitted to use the deployment descriptor to override a bean's concurrency management type regardless of whether it has been explicitly specified or defaulted by the Bean Provider. (See Chapter 19 for information about the deployment descriptor.)

4.8.5.4 Specification of the Container Managed Concurrency Metadata for a Bean's Methods

The Bean Provider of a Singleton bean with container managed concurrency demarcation may specify locking metadata for the enterprise bean's methods. By default, the value of the lock associated with a method of a bean with container managed concurrency demarcation is `Write(exclusive)`, and the concurrency lock attribute does not need to be explicitly specified in this case.

A concurrency locking attribute is a value associated with each of the following methods:

- a method of a bean's business interface
- a method of a bean's no-interface view
- a timeout callback method
- a web service endpoint method

The concurrency locking attribute specifies how the container must manage concurrency when a client invokes the method.

Concurrency locking attributes are specified for the following methods:

- For a bean written to the EJB 3.x client view API, the concurrency locking attributes are specified for those methods of the bean class that correspond to the bean's business interface, the direct and indirect superinterfaces of the business interface, methods exposed through the no-interface view, and for timeout callback methods, if any.
- For a bean that provides a web service client view, the concurrency locking attributes are specified for those methods of the bean class that correspond to the bean's web service endpoint methods, and for timeout callback methods, if any.

By default, if a concurrency locking attribute annotation is not specified for a method of a Singleton bean with container managed concurrency demarcation, the value of the concurrency locking attribute for the method is defined to be `Write`.

The Bean Provider may use the deployment descriptor as an alternative to metadata annotations to specify the concurrency locking attributes (or as a means to supplement or override metadata annotations for concurrency locking attributes). Concurrency locking attributes specified in the deployment descriptor are assumed to override or supplement concurrency locking attributes specified in annotations. If a concurrency locking attribute value is not specified in the deployment descriptor, it is assumed that the concurrency locking attribute specified in annotations applies, or — in the case that no annotation has been specified — that the value is `Write`.

The application assembler is permitted to override the concurrency locking attribute values using the bean's deployment descriptor. The deployer is also permitted to override the concurrency locking attribute values at deployment time. Caution should be exercised when overriding the concurrency locking attributes of an application, as the concurrency structure of an application is typically intrinsic to the semantics of the application.

4.8.5.5 Specification of Concurrency Locking Attributes with Metadata Annotations

The following is the description of the rules for the specification of concurrency attributes using Java language metadata annotations.

The `Lock(READ)` and `Lock(WRITE)` annotations are used to specify a concurrency locking attributes.

The concurrency locking attributes for the methods of a bean class may be specified on the class, the business methods of the class, or both.

Specifying the `Lock` annotation on the bean class means that it applies to all applicable business methods of the class. If the concurrency locking attribute is not specified, it is assumed to be `Lock(WRITE)`. The absence of a concurrency attribute specification on the bean class is equivalent to the specification of `Lock(WRITE)` on the bean class.

A concurrency locking attribute may be specified on a method of the bean class to override the concurrency locking attribute value explicitly or implicitly specified on the bean class.

If the bean class has superclasses, the following additional rules apply:

- A concurrency locking attribute specified on a superclass `S` applies to the business methods defined by `S`. If a class-level concurrency attribute is not specified on `S`, it is equivalent to specification of `Lock(WRITE)` on `S`.
- A concurrency locking attribute may be specified on a business method `M` defined by class `S` to override for method `M` the concurrency locking attribute value explicitly or implicitly specified on the class `S`.
- If a method `M` of class `S` overrides a business method defined by a superclass of `S`, the concurrency locking attribute of `M` is determined by the above rules as applied to class `S`.

Example:

```
@Lock(READ)
public class SomeClass {
    public void aMethod () { ... }
    public void bMethod () { ... }
    ...
}

@Singleton public class ABean extends SomeClass implements A {

    public void aMethod () { ... }

    @Lock(WRITE)
    public void cMethod () { ... }

    ...
}
```

Assuming `aMethod`, `bMethod`, `cMethod` of Singleton bean `ABean` are methods of business interface `A`, their concurrency locking attributes are `Lock(WRITE)`, `Lock(READ)`, and `Lock(WRITE)` respectively.

4.8.5.5.1 Concurrent Access Timeouts

A concurrent access attempt that can not immediately acquire the appropriate lock is blocked until it can make forward progress. `@AccessTimeout` is used to specify the amount of time the access attempt should be blocked before timing out. Access timeouts only apply to methods eligible for concurrency locks on a Singleton bean with container managed concurrency. If an access attempt times out, the container throws a `javax.ejb.ConcurrentAccessTimeoutException` to the client.

`@AccessTimeout` can be specified on a business method or on a bean class (or super-class). An `@AccessTimeout` specified on a class applies the access timeout to all business methods of that class. If `@AccessTimeout` is specified on both a class and on a business method of that class, the method-level annotation takes precedence.

An `@AccessTimeout` value of `-1` indicates that the client request will block indefinitely until forward progress can be made.

An `@AccessTimeout` value of `0` indicates that concurrent access is not allowed. Access attempts on methods with a timeout value of `0` result in a `javax.ejb.ConcurrentAccessException`.

4.8.6 Operations Allowed in the Methods of a Singleton Session Bean

Table 3 defines the methods of a singleton session bean class in which the session bean instances can access the methods of the `javax.ejb.SessionContext` interface, the `java:comp/env` environment naming context, resource managers, `TimerService` and `Timer` methods, the `EntityManager` and `EntityManagerFactory` methods, and other enterprise beans.

If a session bean instance attempts to invoke a method of the `SessionContext` interface, and the access is not allowed in Table 3, the container must throw the `java.lang.IllegalStateException`.

If a session bean instance attempts to invoke a method of the `TimerService` or `Timer` interface and the access is not allowed in Table 3, the container must throw the `java.lang.IllegalStateException`.

If a session bean instance attempts to access a resource manager, an enterprise bean, an entity manager or entity manager factory, and the access is not allowed in Table 3, the behavior is undefined by the EJB architecture.

Table 3 Operations Allowed in the Methods of a Singleton Session Bean

Bean method	Bean method can perform the following operations	
	Container-managed transaction demarcation	Bean-managed transaction demarcation
constructor	-	-
dependency injection-methods	SessionContext methods: <i>lookup</i> JNDI access to java:comp/env	SessionContext methods: <i>lookup</i> JNDI access to java:comp/env
PostConstruct, Pre-Destroy lifecycle callback interceptor methods	SessionContext methods: <i>getBusinessObject, getRollbackOnly, setRollbackOnly, getTimerService, lookup, getContextData</i> JNDI access to java:comp/env Resource manager access Enterprise bean access EntityManagerFactory access EntityManager access TimerService and Timer methods	SessionContext methods: <i>getBusinessObject, getUserTransaction, getTimerService, lookup, getContextData</i> UserTransaction methods JNDI access to java:comp/env Resource manager access Enterprise bean access EntityManager access EntityManagerFactory access TimerService and Timer methods
business method from business interface or from no-interface view ; business method interceptor method	SessionContext methods: <i>getBusinessObject, getCallerPrincipal, isCallerInRole, getRollbackOnly, setRollbackOnly, getTimerService, getInvokedBusinessInterface, wasCancelCalled, lookup, getContextData</i> JNDI access to java:comp/env Resource manager access Enterprise bean access EntityManagerFactory access EntityManager access TimerService and Timer methods	SessionContext methods: <i>getBusinessObject, getCallerPrincipal, isCallerInRole, getUserTransaction, getTimerService, getInvokedBusinessInterface, wasCancelCalled, lookup, getContextData</i> UserTransaction methods JNDI access to java:comp/env Resource manager access Enterprise bean access EntityManagerFactory access EntityManager access TimerService and Timer methods

Table 3 Operations Allowed in the Methods of a Singleton Session Bean

Bean method	Bean method can perform the following operations	
	Container-managed transaction demarcation	Bean-managed transaction demarcation
business method from web service endpoint	SessionContext methods: <i>getBusinessObject</i> , <i>getCallerPrincipal</i> , <i>isCallerInRole</i> , <i>getRollbackOnly</i> , <i>setRollbackOnly</i> , <i>getTimerService</i> , <i>getMessageContext</i> , <i>lookup</i> , <i>getContextData</i> Message context methods JNDI access to java:comp/env Resource manager access Enterprise bean access EntityManagerFactory access EntityManager access TimerService and Timer methods	SessionContext methods: <i>getBusinessObject</i> , <i>getCallerPrincipal</i> , <i>isCallerInRole</i> , <i>getUserTransaction</i> , <i>getTimerService</i> , <i>getMessageContext</i> , <i>lookup</i> , <i>getContextData</i> UserTransaction methods Message context methods JNDI access to java:comp/env Resource manager access Enterprise bean access EntityManagerFactory access EntityManager access TimerService and Timer methods
timeout callback method	SessionContext methods: <i>getBusinessObject</i> , <i>getCallerPrincipal</i> , <i>isCallerInRole</i> , <i>getRollbackOnly</i> , <i>setRollbackOnly</i> , <i>getTimerService</i> , <i>lookup</i> , <i>getContextData</i> JNDI access to java:comp/env Resource manager access Enterprise bean access EntityManagerFactory access EntityManager access TimerService and Timer methods	SessionContext methods: <i>getBusinessObject</i> , <i>getCallerPrincipal</i> , <i>isCallerInRole</i> , <i>getUserTransaction</i> , <i>getTimerService</i> , <i>lookup</i> , <i>getContextData</i> UserTransaction methods JNDI access to java:comp/env Resource manager access Enterprise bean access EntityManagerFactory access EntityManager access TimerService and Timer methods

Additional restrictions:

- The `getRollbackOnly` and `setRollbackOnly` methods of the `SessionContext` interface should be used only in the session bean methods that execute in the context of a transaction. The container must throw the `java.lang.IllegalStateException` if the methods are invoked while the current business method is not executing in the context of a transaction.

The reasons for disallowing operations in Table 3:

- Invoking the `getBusinessObject` method is disallowed if the session bean does not define an EJB 3.x business interface and does not define a no-interface view.
- Invoking the `getInvokedBusinessInterface` method is disallowed if the session bean does not define an EJB 3.x business interface and does not define a no-interface view. It is also disallowed if the current business method was not invoked through a business interface or the no-interface view.
- Invoking the `getEJBObject` and `getEJBHome` methods is disallowed since a singleton session bean does not support the EJB 2.x Remote client view.
- Invoking the `getEJBLocalObject` and `getEJBLocalHome` methods is disallowed since a singleton session bean does not support the EJB 2.x Local client view.
- Invoking the `getRollbackOnly` and `setRollbackOnly` methods is disallowed in the session bean methods for which the container does not have a meaningful transaction context, and for all session beans with bean-managed transaction demarcation.
- Invoking the `getMessageContext` method is disallowed in session bean methods that were not invoked by the container through the session bean's web service endpoint. The `getMessageContext` method returns the `javax.xml.rpc.handler.MessageContext` interface of a stateless session bean that implements a JAX-RPC web service endpoint.
- Accessing resource managers, enterprise beans, and the `EntityManager` is disallowed in the session bean methods for which the container does not have a meaningful transaction context and/or client security context.
- The `UserTransaction` interface is unavailable to session beans with container-managed transaction demarcation.

4.9 The Responsibilities of the Bean Provider

This section describes the responsibilities of the session Bean Provider to ensure that a session bean can be deployed in any EJB container.

4.9.1 Classes and Interfaces

The session Bean Provider is responsible for providing the following class files^[22]:

- Session bean class.
- Session bean's business interface(s), if the session bean provides an EJB 3.x local or remote client view.
- Session bean's remote interface and remote home interface, if the session bean provides an EJB 2.1 remote client view.
- Session bean's local interface and local home interface, if the session bean provides an EJB 2.1 local client view.
- Session bean's web service endpoint interface, if any.
- Interceptor classes, if any.

The Bean Provider for a session bean that provides a web service client view may also define JAX-WS or JAX-RPC message handlers for the bean. The requirements for such message handlers are defined in [31] and [32].

4.9.2 Session Bean Class

The following are the requirements for the session bean class:

- The class must be defined as `public`, must not be `final`, and must not be `abstract`. The class must be a top level class.
- The class must have a `public` constructor that takes no parameters. The container uses this constructor to create instances of the session bean class.
- The class must not define the `finalize()` method.
- The class must implement the bean's business interface(s) or the methods of the bean's business interface(s), if any.
- The class must implement the business methods of the bean's EJB 2.1 client view interfaces, if any.^[23]

Optionally:

- The class may implement, directly or indirectly, the `javax.ejb.SessionBean` interface.^[24]

[22] Note that the interfaces provided by the Bean Provider may have been generated by tools.

[23] Note that the EJB 2.x client view is not supported for Singleton session beans.

- If the class is a stateful session bean, it may implement the `javax.ejb.SessionSynchronization` interface or use one or more of the session synchronization annotations.
- The class may implement the session bean's web service endpoint or component interface.
- If the class is a stateless session bean, it may implement the `javax.ejb.TimedObject` interface. See Chapter 18, "Timer Service".
- The class may implement the `ejbCreate` method(s).
- The session bean class may have superclasses and/or superinterfaces. If the session bean has superclasses, the business methods, lifecycle callback interceptor methods, the timeout callback methods, the methods implementing the optional session synchronization notifications, the `Init` or `ejbCreate<METHOD>` methods, the `Remove` methods, and the methods of the `SessionBean` interface, may be defined in the session bean class, or in any of its superclasses.
- The session bean class is allowed to implement other methods (for example helper methods invoked internally by the business methods) in addition to the methods required by the EJB specification.

4.9.2.1 Session Bean Superclasses

A session bean class is permitted to have superclasses that are themselves session bean classes. However, there are no special rules that apply to the processing of annotations or the deployment descriptor for this case. For the purposes of processing a particular session bean class, all superclass processing is identical regardless of whether the superclasses are themselves session bean classes. In this regard, the use of session bean classes as superclasses merely represents a convenient use of *implementation inheritance*, but does not have *component inheritance* semantics.

As an example, the client views exposed by a particular session bean are not inherited by a subclass that also happens to define a session bean.

```
@Stateless
public class A implements Foo { ... }

@Stateless
public class B extends A implements Bar { ... }
```

Assuming `Foo` and `Bar` are local business interfaces and there is no associated deployment descriptor, session bean A exposes local business interface `Foo` and session bean B exposes local business interface `Bar`, but *not* `Foo`.

[24] Except for Singleton beans.

Session bean B would need to explicitly include `Foo` in its set of exposed views for that interface to apply. For example:

```
@Stateless
public class A implements Foo { ... }

@Stateless
public class B extends A implements Foo, Bar { ... }
```

4.9.3 Lifecycle Callback Interceptor Methods

`PostConstruct`, `PreDestroy`, `PrePassivate`, and `PostActivate` lifecycle callback interceptor methods may be defined for session beans. If `PrePassivate` or `PostActivate` lifecycle callbacks are defined for stateless session beans or singleton beans, they are ignored.^[25]

Compatibility Note: If the `PostConstruct` lifecycle callback interceptor method is the `ejbCreate` method, if the `PreDestroy` lifecycle callback interceptor method is the `ejbRemove` method, if the `PostActivate` lifecycle callback interceptor method is the `ejbActivate` method, or if the `PrePassivate` lifecycle callback interceptor method is the `ejbPassivate` method, these callback methods must be implemented on the bean class itself (or on its superclasses). Except for these cases, the method names can be arbitrary, but must not start with “`ejb`” to avoid conflicts with the callback methods defined by the `javax.ejb.EnterpriseBean` interfaces.

Lifecycle callback interceptor methods may be defined on the bean class and/or on an interceptor class of the bean. Rules applying to the definition of lifecycle callback interceptor methods are defined in Section 12.5, “Interceptors for LifeCycle Event Callbacks” .

4.9.4 Session Synchronization Methods

The bean class (or superclass) of a stateful session bean may use one or more of the session synchronization annotations `@AfterBegin`, `@BeforeCompletion`, and `@AfterCompletion`. Each bean has at most one session synchronization method for each of the three annotation types. In the case of method overriding of session synchronization methods declared by annotations, the most derived method takes precedence. The signatures of the session synchronization methods must follow these rules :

- The method must not be declared as `final` or `static`.
- The method may have any access type : `public`, `private`, `protected`, or package-level.
- The return type must be `void`.
- The `@AfterBegin` and `@BeforeCompletion` methods must take 0 arguments.
- The `@AfterCompletion` method must take a single argument of type `boolean`.

[25] Note that this might result from the use of default interceptors, for example.

4.9.5 `ejbCreate`<METHOD> Methods

The session bean class of a session bean that has a home interface may define one or more `ejbCreate`<METHOD> methods. These `ejbCreate` methods are intended for use only with the EJB 2.1 components. The signatures of the `ejbCreate` methods must follow these rules:

- The method name must have `ejbCreate` as its prefix.
- The method must be declared as `public`.
- The method must not be declared as `final` or `static`.
- The return type must be `void`.
- The method arguments must be legal types for RMI/IIOP if there is a `create`<METHOD> corresponding to the `ejbCreate`<METHOD> method on the session bean's remote home interface.
- A stateless session bean may define only a single `ejbCreate` method, with no arguments.
- The `throws` clause may define arbitrary application exceptions, possibly including the `javax.ejb.CreateException`.

Compatibility Note: EJB 1.0 allowed the `ejbCreate` method to throw the `java.rmi.RemoteException` to indicate a non-application exception. This practice was deprecated in EJB 1.1—an EJB 1.1 or EJB 2.0 or later compliant enterprise bean should throw the `javax.ejb.EJBException` or another `RuntimeException` to indicate non-application exceptions to the container (see Section 14.2.2). An EJB 2.0 and later compliant enterprise bean should not throw the `java.rmi.RemoteException` from the `ejbCreate` method.

4.9.6 Business Methods

The session bean class may define zero or more business methods whose signatures must follow these rules:

- The method names can be arbitrary, but they must not start with “`ejb`” to avoid conflicts with the callback methods used by the EJB architecture.
- The business method must be declared as `public`.
- The method must not be declared as `final` or `static`.
- The argument and return value types for a method must be legal types for RMI/IIOP if the method corresponds to a business method on the session bean's remote business interface or remote interface.

- The argument and return value types for a method must be legal types for JAX-WS / JAX-RPC if the method is a web service method or corresponds to a method on the session bean's web service endpoint.
- The `throws` clause may define arbitrary application exceptions.

Note : Callback methods are permitted to have `public` access type. This raises the question of whether a callback method can also be exposed as a business method through one or more client views. Doing so is not prohibited, but should be done with caution. The runtime context (e.g. transaction context, caller principal, operations allowed, etc.) for a method invoked as a callback can differ significantly from the context for the same method invoked via a client invocation. As a general rule, callback methods should not be exposed as business methods. Therefore, it is recommended that all non-business methods be assigned an access type other than `public`.

Compatibility Note: EJB 1.0 allowed the business methods to throw the `java.rmi.RemoteException` to indicate a non-application exception. This practice was deprecated in EJB 1.1—an EJB 1.1 or EJB 2.0 or later compliant enterprise bean should throw the `javax.ejb.EJBException` or another `RuntimeException` to indicate non-application exceptions to the container (see Section 14.2.2). An EJB 2.0 or later compliant enterprise bean should not throw the `java.rmi.RemoteException` from a business method.

4.9.7 Session Bean's Business Interface

The following are the requirements for the session bean's business interface:

- The interface must not extend the `javax.ejb.EJBObject` or `javax.ejb.EJBLocalObject` interface.
- If the business interface is a remote business interface, the argument and return values must be of valid types for RMI/IIOP. The remote business interface is not required or expected to be a `java.rmi.Remote` interface. The `throws` clause should not include the `java.rmi.RemoteException`. The methods of the business interface may only throw the `java.rmi.RemoteException` if the interface extends `java.rmi.Remote`.
- The interface is allowed to have superinterfaces.
- If the interface is a remote business interface, its methods must not expose local interface types, timers or timer handles, or the managed collection classes that are used for EJB 2.1 entity beans with container-managed persistence as arguments or results.
- The bean class must implement the interface or the interface must be designated as a local or remote business interface of the bean by means of the `Local` or `Remote` annotation or in the deployment descriptor. The following rules apply:
 - If the bean does not expose any other business interfaces (Local, Remote) or No-Interface view, and the bean class implements a single interface, that interface is assumed to be the business interface of the bean. This business interface will be a local interface unless the interface is designated as a remote business interface by use

of the `Remote` annotation on the bean class or interface or by means of the deployment descriptor.

- A bean class is permitted to have more than one interface. If a bean class has more than one interface—excluding the interfaces listed below—any business interface of the bean class must be explicitly designated as a business interface of the bean by means of the `Local` or `Remote` annotation on the bean class or interface or in the deployment descriptor.
- The following interfaces are excluded when determining whether the bean class has more than one interface: `java.io.Serializable`; `java.io.Externalizable`; any of the interfaces defined by the `javax.ejb` package.
- The same business interface cannot be both a local and a remote business interface of the bean.^[26]
- While it is expected that the bean class will typically implement its business interface(s), if the bean class uses annotations or the deployment descriptor to designate its business interface(s), it is not required that the bean class also be specified as implementing the interface(s).

4.9.8 Session Bean's No-Interface View

The following are the requirements for a session bean that exposes a no-interface view :

- The bean class must designate that it exposes a no-interface view via its bean class definition or in the deployment descriptor. The following rules apply :
 - If the bean does not expose any other client views (`Local`, `Remote`, `No-Interface`, `2.x Remote Home`, `2.x Local Home`, `Web Service`) and its implements clause is empty, the bean defines a no-interface view.
 - If the bean exposes at least one other client view, the bean designates that it exposes a no-interface view by means of the `@LocalBean` annotation on the bean class or in the deployment descriptor.
 - The following interfaces are excluded when determining whether the bean exposes a no-interface view : `java.io.Serializable`; `java.io.Externalizable`; any of the interfaces defined by the `javax.ejb` package.
- All `public` methods of the bean class and any superclasses are exposed as business methods through the no-interface view. [Note : This includes callback methods. The Bean Developer should exercise caution when choosing to expose callback methods as business methods through the no-interface view. The runtime context(e.g. transaction context, caller principal, operations allowed, etc.) for a method invoked as a callback can differ significantly from the context for the same method invoked via a client invocation. In general, callback methods should not be exposed as business methods. Therefore, it is recommended that all non-business methods be assigned an access type other than `public`.]
- The `throws` clause of a bean class method exposed through the no-interface view must not include the `java.rmi.RemoteException`.

[26] It is also an error if the `Local` and/or `Remote` annotations are specified both on the bean class and on the referenced interface and the values differ.

- All methods of the bean class and any superclasses must not be declared `final`.

4.9.9 Session Bean's Remote Interface

The following are the requirements for the session bean's remote interface:

- The interface must extend the `javax.ejb.EJBObject` interface.
- The methods defined in this interface must follow the rules for RMI/IIOP. This means that their argument and return values must be of valid types for RMI/IIOP, and their `throws` clauses must include the `java.rmi.RemoteException`.
- The remote interface is allowed to have superinterfaces. Use of interface inheritance is subject to the RMI/IIOP rules for the definition of remote interfaces.
- For each method defined in the remote interface, there must be a matching method in the session bean's class. The matching method must have:
 - The same name.
 - The same number and types of arguments, and the same return type.
 - All the exceptions defined in the `throws` clause of the matching method of the session bean class must be defined in the `throws` clause of the method of the remote interface.
- The remote interface methods must not expose local interface types, local home interface types, timers or timer handles, or the managed collection classes that are used for entity beans with container-managed persistence as arguments or results.

4.9.10 Session Bean's Remote Home Interface

The following are the requirements for the session bean's remote home interface:

- The interface must extend the `javax.ejb.EJBHome` interface.
- The methods defined in this interface must follow the rules for RMI/IIOP. This means that their argument and return values must be of valid types for RMI/IIOP, and that their `throws` clauses must include the `java.rmi.RemoteException`.
- The remote home interface is allowed to have superinterfaces. Use of interface inheritance is subject to the RMI/IIOP rules for the definition of remote interfaces.
- A session bean's remote home interface must define one or more `create<METHOD>` methods. A stateless session bean must define exactly one `create` method with no arguments.
- Each `create` method of a stateful session bean must be named `create<METHOD>`, and it must match one of the `Init` methods or `ejbCreate<METHOD>` methods defined in the ses-

sion bean class. The matching `Init` method or `ejbCreate<METHOD>` method must have the same number and types of arguments. (Note that the return type is different.) The `create` method for a stateless session bean must be named “`create`” but need not have a matching “`ejbCreate`” method.

- The return type for a `create<METHOD>` method must be the session bean’s remote interface type.
- All the exceptions defined in the `throws` clause of an `ejbCreate<METHOD>` method of the session bean class must be defined in the `throws` clause of the matching `create<METHOD>` method of the remote home interface.
- The `throws` clause must include `javax.ejb.CreateException`.

4.9.11 Session Bean’s Local Interface

The following are the requirements for the session bean’s local interface:

- The interface must extend the `javax.ejb.EJBLocalObject` interface.
- The `throws` clause of a method defined in the local interface must not include the `java.rmi.RemoteException`.
- The local interface is allowed to have superinterfaces.
- For each method defined in the local interface, there must be a matching method in the session bean’s class. The matching method must have:
 - The same name.
 - The same number and types of arguments, and the same return type.
 - All the exceptions defined in the `throws` clause of the matching method of the session bean class must be defined in the `throws` clause of the method of the local interface.

4.9.12 Session Bean’s Local Home Interface

The following are the requirements for the session bean’s local home interface:

- The interface must extend the `javax.ejb.EJBLocalHome` interface.
- The `throws` clause of a method in the local home interface must not include the `java.rmi.RemoteException`.
- The local home interface is allowed to have superinterfaces.
- A session bean’s local home interface must define one or more `create<METHOD>` methods. A stateless session bean must define exactly one `create` method with no arguments.

- Each `create` method of a stateful session bean must be named `create<METHOD>`, and it must match one of the `Init` methods or `ejbCreate<METHOD>` methods defined in the session bean class. The matching `Init` method or `ejbCreate<METHOD>` method must have the same number and types of arguments. (Note that the return type is different.) The `create` method for a stateless session bean must be named “`create`” but need not have a matching “`ejbCreate`” method.
- The return type for a `create<METHOD>` method must be the session bean’s local interface type.
- All the exceptions defined in the `throws` clause of an `ejbCreate<METHOD>` method of the session bean class must be defined in the `throws` clause of the matching `create<METHOD>` method of the local home interface.
- The `throws` clause must include `javax.ejb.CreateException`.

4.9.13 Session Bean’s Web Service Endpoint Interface

EJB 3.1 does not require the definition of a web service endpoint interface for session beans that implement a web service endpoint.

The following are requirements for stateless session beans with JAX-RPC web service endpoint interfaces. The JAX-WS and Web Services for Java EE specifications do not require that a separate interface be defined for a web service endpoint. The requirements for web service endpoints under JAX-WS and Web Services for Java EE are given in [32] and [31].

The following are the requirements for a stateless session bean’s web service endpoint interface. The web service endpoint interface must follow the rules for JAX-RPC service endpoint interfaces [25].

- The web service endpoint interface must extend the `java.rmi.Remote` interface.
- The methods defined in the interface must follow the rules for JAX-RPC service endpoint interfaces. This means that their argument and return values must be of valid types for JAX-RPC, and their `throws` clauses must include the `java.rmi.RemoteException`. The `throws` clause may additionally include application exceptions.

Note that JAX-RPC Holder classes may be used as method parameters. The JAX-RPC specification requires support for Holder classes as part of the standard Java mapping of WSDL operations in order to handle out and inout parameters. Holder classes implement the `javax.xml.rpc.holders.Holder` interface. See the JAX-RPC specification [25] for further details.

- For each method defined in the web service endpoint interface, there must be a matching method in the session bean’s class. The matching method must have:
 - The same name.
 - The same number and types of arguments, and the same return type.
 - All the exceptions defined in the `throws` clause of the matching method of the session bean class must be defined in the `throws` clause of the method of the web service endpoint interface.

- The web service endpoint interface must not include an EJBObject or EJBLocalObject as either a parameter or return type. An array or JAX-RPC value type must not include an EJBObject or EJBLocalObject as a contained element. The web service endpoint interface methods must not expose business interface types, local or remote interface types, local or remote home interface types, timers or timer handles, or the managed collection classes that are used for entity beans with container-managed persistence as arguments or results or as fields of value types.
- JAX-RPC serialization rules apply for any value types that are used by the web service endpoint interface. If it is important that Java serialization semantics apply, the Bean Provider should use the restricted set of JAX-RPC value types for which the semantics of Java serialization apply under JAX-RPC serialization. See the JAX-RPC specification [25] for details.
- The web service endpoint interface must not include constant (as `public final static`) declarations.
- The Bean Provider must designate the web service endpoint interface in the deployment descriptor by means of the `service-endpoint` element. The service endpoint itself is only exposed within a web service if it is referenced by a web service deployment descriptor as defined by [31].

JAX-RPC Web Service Endpoints have been proposed for future removal. See Section 2.7 for more details.

4.10 The Responsibilities of the Container Provider

This section describes the responsibilities of the Container Provider to support a session bean. The Container Provider is responsible for providing the deployment tools and for managing the session bean instances at runtime.

Because the EJB specification does not define the API between deployment tools and the container, we assume that the deployment tools are provided by the Container Provider. Alternatively, the deployment tools may be provided by a different vendor who uses the container vendor's specific API.

4.10.1 Generation of Implementation Classes

The deployment tools provided by the container are responsible for the generation of additional classes when the session bean is deployed. The tools obtain the information that they need for generation of the additional classes by introspecting the classes and interfaces provided by the Bean Provider and by examining the session bean's deployment descriptor.

The deployment tools must generate the following classes:

- A class that implements the session bean's business interface.
- A class that implements the session bean's no-interface view.

- A class that implements the session bean's remote home interface (session EJBHome class).
- A class that implements the session bean's remote interface (session EJBObject class).
- A class that implements the session bean's local home interface (session EJBLocalHome class).
- A class that implements the session bean's local interface (session EJBLocalObject class).
- A class that implements the session bean's web service endpoint.
- A class that implements the return value of an asynchronous method with return type `Future<V>`.

The deployment tools may also generate a class that mixes some container-specific code with the session bean class. This code may, for example, help the container to manage the bean instances at runtime. The tools can use subclassing, delegation, and code generation.

The deployment tools may also allow the generation of additional code that wraps the business methods and is used to customize the business logic to an existing operational environment. For example, a wrapper for a `debit` function on the `AccountManager` bean may check that the debited amount does not exceed a certain limit.

4.10.2 Generation of WSDL

Reference [31] describes the generation of a WSDL document for a web service endpoint. The Java to WSDL mapping must adhere to the requirements of JAX-RPC or JAX-WS [32].

4.10.3 Session Business Interface Implementation Class

The container's implementation of the session business interface, which is generated by the deployment tools, implements the business methods specific to the session bean.

The implementation of each business method must activate the instance (if the instance is in the passive state), invoke any business method interceptor methods, and invoke the matching business method on the instance.

The container provider is responsible for providing the implementation of the `equals` and `hashCode` methods for the business interface, in conformance with the requirements of section 3.6.5.

4.10.4 No-Interface View Reference Class

The container's implementation of the no-interface view reference, which is generated by the deployment tools, implements the business methods that are exposed to the no-interface view client.

The implementation of each business method must activate the instance (if the instance is in the passive state), invoke any business method interceptor methods, and invoke the matching business method on the instance.

The container provider is responsible for providing the implementation of the equals and hashCode methods for no-interface view reference, in conformance with the requirements of section [3.6.5].

4.10.5 Session EJBHome Class

The session EJBHome class, which is generated by the deployment tools, implements the session bean's remote home interface. This class implements the methods of the `javax.ejb.EJBHome` interface and the `create<METHOD>` methods specific to the session bean.

The implementation of each `create<METHOD>` method invokes a matching `ejbCreate<METHOD>` method.

4.10.6 Session EJBObject Class

The session EJBObject class, which is generated by the deployment tools, implements the session bean's remote interface. It implements the methods of the `javax.ejb.EJBObject` interface and the business methods specific to the session bean.

The implementation of each business method must activate the instance (if the instance is in the passive state), invoke any business method interceptor methods, and invoke the matching business method on the instance.

4.10.7 Session EJBLocalHome Class

The session EJBLocalHome class, which is generated by the deployment tools, implements the session bean's local home interface. This class implements the methods of the `javax.ejb.EJBLocalHome` interface and the `create<METHOD>` methods specific to the session bean.

The implementation of each `create<METHOD>` method invokes a matching `ejbCreate<METHOD>` method.

4.10.8 Session EJBLocalObject Class

The session EJBLocalObject class, which is generated by the deployment tools, implements the session bean's local interface. It implements the methods of the `javax.ejb.EJBLocalObject` interface and the business methods specific to the session bean.

The implementation of each business method must activate the instance (if the instance is in the passive state), invoke any business method interceptor methods, and invoke the matching business method on the instance.

4.10.9 Web Service Endpoint Implementation Class

The implementation class for a stateless session bean's web service endpoint is generated by the container's deployment tools. This class must handle requests to the web service endpoint, unmarshal the SOAP request, invoke any business method interceptor methods, and invoke the stateless session bean method that matches the web service endpoint method that corresponds to the request.

4.10.10 Asynchronous Client Future<V> Return Value Implementation Class

The object returned from an asynchronous method with return type `Future<V>` is implemented by the container's deployment tools.

4.10.11 Handle Classes

The deployment tools are responsible for implementing the handle classes for the session bean's remote home and remote interfaces.

4.10.12 EJBMetaData Class

The deployment tools are responsible for implementing the class that provides metadata to the remote client view contract. The class must be a valid RMI Value class and must implement the `javax.ejb.EJBMetaData` interface.

4.10.13 Non-reentrant Instances

The container must ensure that only one thread can be executing a stateless or stateful session bean instance at any time. Therefore, stateful and stateless session beans do not have to be coded as reentrant. One implication of this rule is that an application cannot make loopback calls to a stateless or stateful session bean instance.

4.10.14 Transaction Scoping, Security, Exceptions

The container must follow the rules with respect to transaction scoping, security checking, and exception handling, as described in Chapters 13, 17, and 14, respectively.

4.10.15 JAX-WS and JAX-RPC Message Handlers for Web Service Endpoints

The container must support the use of JAX-WS and JAX-RPC message handlers for web service endpoints. Container requirements for support of message handlers are specified in [32] and [31].

If message handlers are present, they must be invoked before any business method interceptor methods.

4.10.16 SessionContext

The container must implement the `SessionContext.getEJBObject` method such that the bean instance can use the Java language cast to convert the returned value to the session bean's remote interface type. Specifically, the bean instance does not have to use the `PortableRemoteObject.narrow` method for the type conversion.

The container must implement the `EJBContext.lookup` method such that when the `lookup` method is used to look up a bean's remote home interface, a bean instance can use the Java language cast to convert the returned value to a session bean's remote home interface type. Specifically, the bean instance does not have to use the `PortableRemoteObject.narrow` method for the type conversion.

Message-Driven Bean Component Contract

This chapter specifies the contract between a message-driven bean and its container. It defines the life cycle of the message-driven bean instances.

This chapter defines the developer's view of message-driven bean state management and the container's responsibility for managing message-driven bean state.

5.1 Overview

A message-driven bean is an asynchronous message consumer. A message-driven bean is invoked by the container as a result of the arrival of a message at the destination or endpoint that is serviced by the message-driven bean. A message-driven bean instance is an instance of a message-driven bean class. A message-driven bean is defined for a single messaging type, in accordance with the message listener interface it employs.

To a client, a message-driven bean is a message consumer that implements some business logic running on the server. A client accesses a message-driven bean by sending messages to the destination or endpoint for which the message-driven bean class is the message listener.

Message-driven beans are anonymous. They have no client-visible identity.

Message-driven bean instances have no conversational state. This means that all bean instances are equivalent when they are not involved in servicing a client message.

A message-driven bean instance is created by the container to handle the processing of the messages for which the message-driven bean is the consumer. Its lifetime is controlled by the container.

A message-driven bean instance has no state for a specific client. However, the instance variables of the message-driven bean instance can contain state across the handling of client messages. Examples of such state include an open database connection and a reference to an enterprise bean.

5.2 Goals

The goal of the message-driven bean model is to make developing an enterprise bean that is asynchronously invoked to handle the processing of incoming messages as simple as developing the same functionality in any other message listener.

A further goal of the message-driven bean model is to allow for the concurrent processing of a stream of messages by means of container-provided pooling of message-driven bean instances.

5.3 Client View of a Message-Driven Bean

To a client, a message-driven bean is simply a message consumer. The client sends messages to the destination or endpoint for which the message-driven bean is the message listener just as it would to any other destination or endpoint. The message-driven bean, as a message consumer, handles the processing of the messages.

From the perspective of the client, the existence of a message-driven bean is completely hidden behind the destination or endpoint for which the message-driven bean is the message listener. The following diagram illustrates the view that is provided to a message-driven bean's clients.

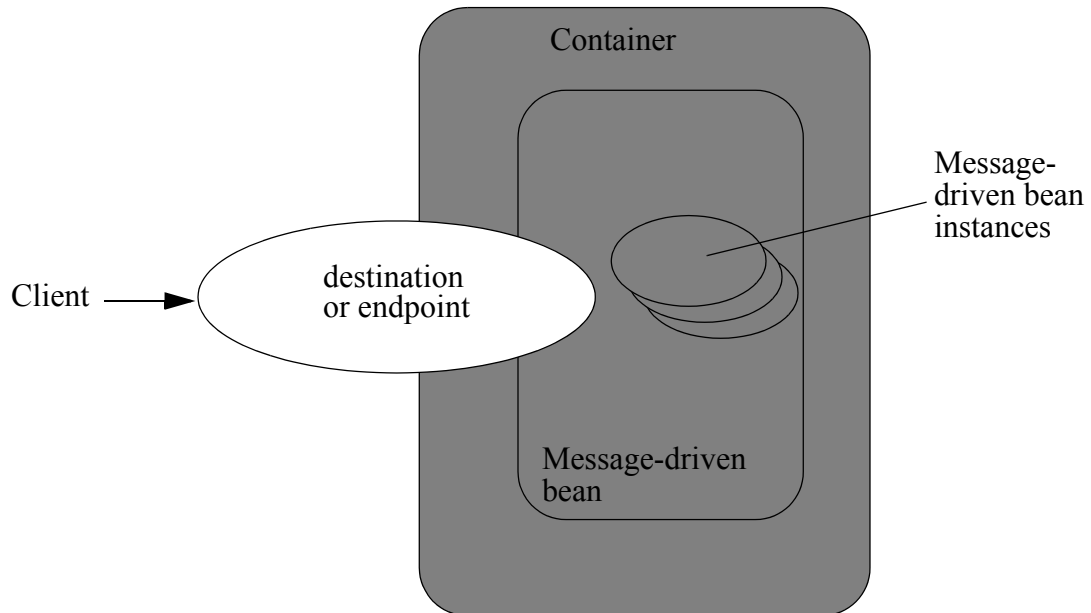
Figure 8 Client view of Message-Driven Beans Deployed in a Container

A client's JNDI name space may be configured to include the destinations or endpoints of message-driven beans installed in multiple EJB containers located on multiple machines on a network. The actual locations of an enterprise bean and EJB container are, in general, transparent to the client using the enterprise bean.

References to message destinations can be injected, or they can be looked up in the client's JNDI namespace.

For example, the reference to the queue for a JMS message-driven bean might be injected as follows.

```
@Resource Queue stockInfoQueue;
```

Alternatively, the queue for the `StockInfo` JMS message-driven bean might be located using the following code segment:

```
Context initialContext = new InitialContext();
Queue stockInfoQueue = (javax.jms.Queue)initialContext.lookup
    ("java:comp/env/jms/stockInfoQueue");
```

The remainder of this section describes the message-driven bean life cycle in detail and the protocol between the message-driven bean and its container.

5.4 Protocol Between a Message-Driven Bean Instance and its Container

From its creation until destruction, a message-driven bean instance lives in a container. The container provides security, concurrency, transactions, and other services for the message-driven bean. The container manages the life cycle of the message-driven bean instances, notifying the instances when bean action may be necessary, and providing a full range of services to ensure that the message-driven bean implementation is scalable and can support the concurrent processing of a large number of messages.

From the Bean Provider's point of view, a message-driven bean exists as long as its container does. It is the container's responsibility to ensure that the message-driven bean comes into existence when the container is started up and that instances of the bean are ready to receive an asynchronous message delivery before the delivery of messages is started.

Containers themselves make no actual service demands on the message-driven bean instances. The calls a container makes on a bean instance provide it with access to container services and deliver notifications issued by the container.

Since all instances of a message-driven bean are equivalent, a client message can be delivered to any available instance.

5.4.1 Required MessageDrivenBean Metadata

A message-driven bean must be annotated with the `MessageDriven` annotation or denoted in the deployment descriptor as a message-driven bean.

5.4.2 The Required Message Listener Interface

The message-driven bean class must implement the appropriate message listener interface for the messaging type that the message-driven bean supports or specify the message listener interface using the `MessageDriven` metadata annotation or the `messaging-type` deployment descriptor element. The specific message listener interface that is implemented by a message-driven bean class distinguishes the messaging type that the message-driven bean supports.

The message-driven bean class's implementation of the `javax.jms.MessageListener` interface distinguishes the message-driven bean as a JMS message-driven bean.

The bean's message listener method (e.g., `onMessage` in the case of `javax.jms.MessageListener`) is called by the container when a message has arrived for the bean to service. The message listener method contains the business logic that handles the processing of the message.

A bean's message listener interface may define more than one message listener method. If the message listener interface contains more than one method, it is the resource adapter that determines which method is invoked. See [15].

If the message-driven bean class implements more than one interface other than `java.io.Serializable`, `java.io.Externalizable`, or any of the interfaces defined by the `javax.ejb` package, the message listener interface must be specified by the `messageListenerInterface` element of the `MessageDriven` annotation or the `messaging-type` element of the `message-driven` deployment descriptor element.

5.4.3 Dependency Injection

A message-driven bean may use dependency injection mechanisms to acquire references to resources or other objects in its environment (see Chapter 16, "Enterprise Bean Environment"). If a message-driven bean makes use of dependency injection, the container injects these references after the bean instance is created, and before any message-listener methods are invoked on the bean instance. If a dependency on the `MessageDrivenContext` is declared, or if the bean class implements the optional `MessageDrivenBean` interface (see Section 5.4.6), the `MessageDrivenContext` is also injected at this time. If dependency injection fails, the bean instance is discarded.

Under the EJB 3.x API, the bean class may acquire the `MessageDrivenContext` interface through dependency injection without having to implement the `MessageDrivenBean` interface. In this case, the `Resource` annotation (or `resource-env-ref` deployment descriptor element) is used to denote the bean's dependency on the `MessageDrivenContext`. See Chapter 16, "Enterprise Bean Environment".

5.4.4 The MessageDrivenContext Interface

If the bean specifies a dependency on the `MessageDrivenContext` interface (or if the bean class implements the `MessageDrivenBean` interface), the container must provide the message-driven bean instance with a `MessageDrivenContext`. This gives the message-driven bean instance access to the instance's context maintained by the container. The `MessageDrivenContext` interface has the following methods:

- The `setRollbackOnly` method allows the instance to mark the current transaction such that the only outcome of the transaction is a rollback. Only instances of a message-driven bean with container-managed transaction demarcation can use this method.
- The `getRollbackOnly` method allows the instance to test if the current transaction has been marked for rollback. Only instances of a message-driven bean with container-managed transaction demarcation can use this method.

- The `getUserTransaction` method returns the `javax.transaction.UserTransaction` interface that the instance can use to demarcate transactions, and to obtain transaction status. Only instances of a message-driven bean with bean-managed transaction demarcation can use this method.
- The `getTimerService` method returns the `javax.ejb.TimerService` interface.
- The `getCallerPrincipal` method returns the `java.security.Principal` that is associated with the invocation.
- The `isCallerInRole` method is inherited from the `EJBContext` interface.
- The `getEJBHome` and `getEJBLocalHome` methods are inherited from the `EJBContext` interface. Message-driven bean instances must not call these methods.
- The `lookup` method enables the message-driven bean to look up its environment entries in the JNDI naming context.
- The `getContextData` method enables a business method, lifecycle callback method, or timeout method to retrieve any interceptor/webservices context associated with its invocation.

5.4.5 Message-Driven Bean Lifecycle Callback Interceptor Methods

The following lifecycle event callbacks are supported for message-driven beans. Callback methods may be defined directly on the bean class or on a separate interceptor class^[27]. See Section 5.6.5.

- `PostConstruct`
- `PreDestroy`

The `PostConstruct` callback occurs before the first message listener method invocation on the bean. This is at a point after which any dependency injection has been performed by the container.

The `PostConstruct` lifecycle callback interceptor method executes in an unspecified transaction and security context.

The `PreDestroy` callback occurs at the time the bean is removed from the pool or destroyed.

The `PreDestroy` lifecycle callback interceptor method executes in an unspecified transaction and security context.

5.4.6 The Optional MessageDrivenBean Interface

The message-driven bean class is not required to implement the `javax.ejb.MessageDrivenBean` interface.

[27] If `PrePassivate` or `PostActivate` lifecycle callbacks are defined for message-driven beans, they are ignored.

Compatibility Note: The `MessageDrivenBean` interface was required by earlier versions of the Enterprise JavaBeans specification. In EJB 3.x, the functionality previously provided by the `MessageDrivenBean` interface is available to the bean class through selective use of dependency injection (of the `MessageDrivenContext`) and optional lifecycle callback methods.

The `MessageDrivenBean` interface defines two methods, `setMessageDrivenContext` and `ejbRemove`.

The `setMessageDrivenContext` method is called by the bean's container to associate a message-driven bean instance with its context maintained by the container. Typically a message-driven bean instance retains its message-driven context as part of its state.

The `ejbRemove` notification signals that the instance is in the process of being removed by the container. In the `ejbRemove` method, the instance releases the resources that it is holding.

Under the EJB 3.x API, the bean class may optionally define a `PreDestroy` callback method for notification of the container's removal of the bean instance.

This specification requires that the `ejbRemove` and the `ejbCreate` methods of a message-driven bean be treated as the `PreDestroy` and `PostConstruct` lifecycle callback methods, respectively. If the message-driven bean implements the `MessageDrivenBean` interface, the `PreDestroy` annotation can only be applied to the `ejbRemove` method. Similar requirements apply to use of deployment descriptor metadata as an alternative to the use of annotations.

5.4.7 Timeout Callbacks

A message driven bean can be registered with the EJB timer service for time-based event notifications. The container invokes the appropriate bean instance timeout callback method when a timer for the bean has expired. See Chapter 18, "Timer Service".

5.4.8 Message-Driven Bean Creation

The container creates an instance of a message-driven bean in three steps. First, the container calls the bean class' `newInstance` method to create a new message-driven bean instance. Second, the container injects the bean's `MessageDrivenContext`, if applicable, and performs any other dependency injection as specified by metadata annotations on the bean class or by the deployment descriptor. Third, the container calls the instance's `PostConstruct` lifecycle callback methods, if any. See Section 5.6.5.

Compatibility Note: EJB 2.1 required the message-driven bean class to implement the `ejbCreate` method. This requirement has been removed in EJB 3.x. If the message-driven bean class implements the `ejbCreate` method, the `ejbCreate` method is treated as the bean's `PostConstruct` method, and the `PostConstruct` annotation can only be applied to the `ejbCreate` method.

5.4.9 Message Listener Interceptor Methods for Message-Driven Beans

The `AroundInvoke` business method interceptor methods are supported for message-driven beans. These interceptor methods may be defined on the bean class or on an interceptor class and apply to the handling of the invocation of the bean's message listener method(s).

Interceptors are described in Chapter 12, "Interceptors".

5.4.10 Serializing Message-Driven Bean Methods

The container serializes calls to each message-driven bean instance. Most containers will support many instances of a message-driven bean executing concurrently; however, each instance sees only a serialized sequence of method calls. Therefore, a message-driven bean does not have to be coded as reentrant.

The container must serialize all the container-invoked callbacks (e.g., lifecycle callback interceptor methods and timeout callback methods), and it must serialize these callbacks with the message listener method calls.

5.4.11 Concurrency of Message Processing

A container allows many instances of a message-driven bean class to be executing concurrently, thus allowing for the concurrent processing of a stream of messages. No guarantees are made as to the exact order in which messages are delivered to the instances of the message-driven bean class, although the container should attempt to deliver messages in order when it does not impair the concurrency of message processing. Message-driven beans should therefore be prepared to handle messages that are out of sequence: for example, the message to cancel a reservation may be delivered before the message to make the reservation.

5.4.12 Transaction Context of Message-Driven Bean Methods

A bean's message listener and timeout callback methods are invoked in the scope of a transaction determined by the transaction attribute specified in the bean's metadata annotations or deployment descriptor. If the bean is specified as using container-managed transaction demarcation, either the `REQUIRED` or the `NOT_SUPPORTED` transaction attribute must be used for the message listener methods, and either the `REQUIRED`, `REQUIRES_NEW`, or the `NOT_SUPPORTED` transaction attribute for timeout callback methods. See Chapter 13, "Support for Transactions"

When a message-driven bean using bean-managed transaction demarcation uses the `javax.transaction.UserTransaction` interface to demarcate transactions, the message receipt that causes the bean to be invoked is not part of the transaction. If the message receipt is to be part of the transaction, container-managed transaction demarcation with the `REQUIRED` transaction attribute must be used.

The `newInstance` method, `setMessageDrivenContext`, the message-driven bean's dependency injection methods, and lifecycle callback methods are called with an unspecified transaction context. Refer to Subsection 13.6.5 for how the container executes methods with an unspecified transaction context.

5.4.13 Security Context of Message-Driven Bean Methods

A caller principal may propagate into a message-driven bean's message listener methods. Whether this occurs is a function of the specific message-listener interface and associated messaging provider, but is not governed by this specification.

The Bean Provider can use the `@RunAs` metadata annotation (or corresponding deployment descriptor element) to define a run-as identity for the enterprise bean. The run-as identity applies to the bean's message listener methods and timeout methods. Run-as identity behavior is further defined in the Security chapter in Section 17.3.4.1.

5.4.14 Activation Configuration Properties

The Bean Provider may provide information to the Deployer about the configuration of the message-driven bean in its operational environment. This may include information about message acknowledgement modes, message selectors, expected destination or endpoint types, etc.

Activation configuration properties are specified by means of the `activationConfig` element of the `MessageDriven` annotation or `activation-config` deployment descriptor element. Activation configuration properties specified in the deployment descriptor are added to those specified by means of the `MessageDriven` annotation. If a property of the same name is specified in both, the deployment descriptor value overrides the value specified in the annotation.

Activation configuration properties for JMS message-driven beans are described in Sections 5.4.15 through 5.4.17.

5.4.15 Message Acknowledgment for JMS Message-Driven Beans

JMS message-driven beans should not attempt to use the JMS API for message acknowledgment. Message acknowledgment is automatically handled by the container. If the message-driven bean uses container-managed transaction demarcation, message acknowledgment is handled automatically as a part of the transaction commit. If bean-managed transaction demarcation is used, the message receipt cannot be part of the bean-managed transaction, and, in this case, the receipt is acknowledged by the container. If bean-managed transaction demarcation is used, the Bean Provider can indicate whether JMS `AUTO_ACKNOWLEDGE` semantics or `DUPS_OK_ACKNOWLEDGE` semantics should apply by using the

activationConfig element of the MessageDriven annotation or by using the activation-config-property deployment descriptor element. The property name used to specify the acknowledgment mode is acknowledgeMode. If the acknowledgeMode property is not specified, JMS AUTO_ACKNOWLEDGE semantics are assumed. The value of the acknowledgeMode property must be either Auto-acknowledge or Dups-ok-acknowledge for a JMS message-driven bean.

5.4.16 Message Selectors for JMS Message-Driven Beans

The Bean Provider may declare the JMS message selector to be used in determining which messages a JMS message-driven bean is to receive. If the Bean Provider wishes to restrict the messages that a JMS message-driven bean receives, the Bean Provider can specify the value of the message selector by using the activationConfig element of the MessageDriven annotation or by using the activation-config-property deployment descriptor element. The property name used to specify the message selector is messageSelector.

For example:

```
@MessageDriven(activationConfig={
    @ActivationConfigProperty(
        propertyName="messageSelector",
        propertyValue="JMSType = 'car' AND color = 'blue' and weight
> 2500"))})
```

```
<activation-config>
<activation-config-property>
<activation-config-property-name>messageSelector</activation-con-
fig-property-name>
<activation-config-property-value>JMSType = 'car' AND color = 'blue'
AND weight > 2500</activation-config-property-value>
</activation-config-property>
</activation-config>
```

The Application Assembler may further restrict, but not replace, the value of the messageSelector property of a JMS message-driven bean.

5.4.17 Association of a Message-Driven Bean with a Destination or Endpoint

A message-driven bean is associated with a destination or endpoint when the bean is deployed in the container. It is the responsibility of the Deployer to associate the message-driven bean with a destination or endpoint.

5.4.17.1 JMS Message-Driven Beans

A JMS message-driven bean is associated with a JMS Destination (Queue or Topic) when the bean is deployed in the container. It is the responsibility of the Deployer to associate the message-driven bean with a Queue or Topic.

The Bean Provider may provide advice to the Deployer as to whether a message-driven bean is intended to be associated with a queue or a topic by using the `activationConfig` element of the `MessageDriven` annotation or by using the `activation-config-property` deployment descriptor element. The property name used to specify the destination type associated with the bean is `destinationType`. The value for this property must be either `javax.jms.Queue` or `javax.jms.Topic` for a JMS message-driven bean.

If the message-driven bean is intended to be used with a topic, the Bean Provider may further indicate whether a durable or non-durable subscription should be used by using the `activationConfig` element of the `MessageDriven` annotation or by using the `activation-config-property` deployment descriptor element. The property name used to specify whether a durable or non-durable subscription should be used is `subscriptionDurability`. The value for this property must be either `Durable` or `NonDurable` for a JMS message-driven bean. If a topic subscription is specified and `subscriptionDurability` is not specified, a non-durable subscription is assumed.

- Durable topic subscriptions, as well as queues, ensure that messages are not missed even if the EJB server is not running. Reliable applications will typically make use of queues or durable topic subscriptions rather than non-durable topic subscriptions.
- If a non-durable topic subscription is used, it is the container's responsibility to make sure that the message driven bean subscription is active (i.e., that there is a message driven bean available to service the message) in order to ensure that messages are not missed as long as the EJB server is running. Messages may be missed, however, when a bean is not available to service them. This will occur, for example, if the EJB server goes down for any period of time.

The Deployer should avoid associating more than one message-driven bean with the same JMS Queue. If there are multiple JMS consumers for a queue, JMS does not define how messages are distributed between the queue receivers.

5.4.18 Dealing with Exceptions

A message-driven bean's message listener method must not throw the `java.rmi.RemoteException`.

Message-driven beans should not, in general, throw `RuntimeExceptions`.

A `RuntimeException` that is not an application exception thrown from any method of the message-driven bean class (including a message listener method and the callbacks invoked by the container) results in the transition to the "does not exist" state. If a message-driven bean uses bean-managed transaction demarcation and throws a `RuntimeException`, the container should not acknowledge the message. Exception handling is described in detail in Chapter 14. See Section 12.5.1 for the rules pertaining to lifecycle callback interceptor methods when more than one such method applies to the bean class.

From the client perspective, the message consumer continues to exist. If the client continues sending messages to the destination or endpoint associated with the bean, the container can delegate the client's messages to another instance.

The message listener methods of some messaging types may throw application exceptions. An application exception is propagated by the container to the resource adapter.

5.4.19 Missed PreDestroy Callbacks

The Bean Provider cannot assume that the container will always invoke the `PreDestroy` callback method (or `ejbRemove` method) for a message-driven bean instance. The following scenarios result in the `PreDestroy` callback method not being called on an instance:

- A crash of the EJB container.
- A system exception thrown from the instance's method to the container.

If the message-driven bean instance allocates resources in the `PostConstruct` lifecycle callback method and/or in the message listener method, and releases normally the resources in the `PreDestroy` method, these resources will not be automatically released in the above scenarios. The application using the message-driven bean should provide some clean up mechanism to periodically clean up the unreleased resources.

5.4.20 Replying to a JMS Message

In standard JMS usage scenarios, the messaging mode of a message's `JMSReplyTo` destination (Queue or Topic) is the same as the mode of the destination to which the message has been sent. Although a message-driven bean is not directly dependent on the mode of the JMS destination from which it is consuming messages, it may contain code that depends on the mode of its message's `JMSReplyTo` destination. In particular, if a message-driven bean replies to a message, the mode of the reply's message producer and the mode of the `JMSReplyTo` destination must be the same. In order to implement a message-driven bean that is independent of `JMSReplyTo` mode, the Bean Provider should use `instanceOf` to test whether a `JMSReplyTo` destination is a Queue or Topic, and then use a matching message producer for the reply.

5.5 Message-Driven Bean State Diagram

When a client sends a message to a Destination for which a message-driven bean is the consumer, the container selects one of its method-ready instances and invokes the instance's message listener method.

The following figure illustrates the life cycle of a message-driven bean instance.

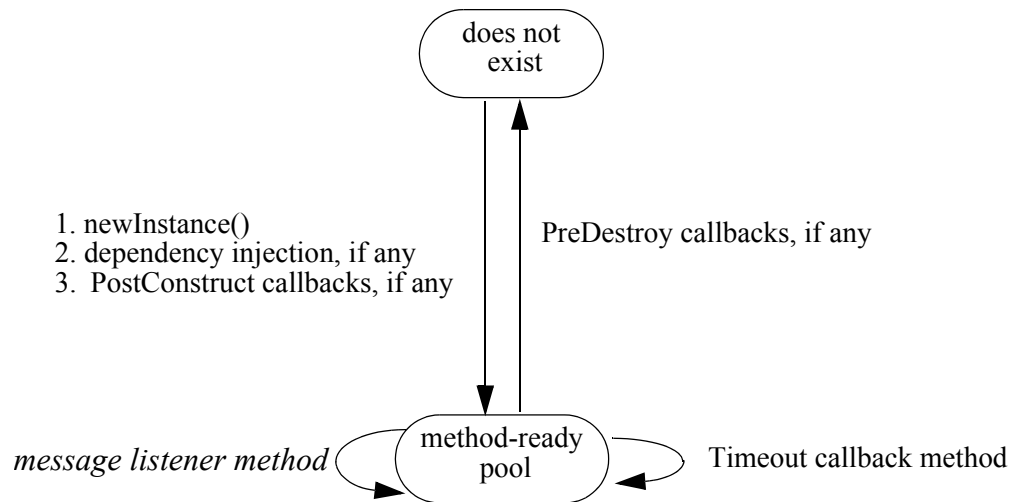
Figure 9 Life Cycle of a Message-Driven Bean.

<i>message listener method</i>	action resulting from client message arrival
<code>newInstance()</code>	action initiated by container

The following steps describe the life cycle of a message-driven bean instance:

- A message-driven bean instance's life starts when the container invokes `newInstance` on the message-driven bean class to create a new instance. Next, the container injects the bean's `MessageDrivenContext`, if applicable, and performs any other dependency injection as specified by metadata annotations on the bean class or by the deployment descriptor. The container then calls the bean's `PostConstruct` lifecycle callback methods, if any.
- The message-driven bean instance is now ready to be delivered a message sent to its associated destination or endpoint by any client or a call from the container to a timeout callback method.
- When the container no longer needs the instance (which usually happens when the container wants to reduce the number of instances in the method-ready pool), the container invokes the `PreDestroy` lifecycle callback methods for it, if any. This ends the life of the message-driven bean instance.

5.5.1 Operations Allowed in the Methods of a Message-Driven Bean Class

Table 4 defines the methods of a message-driven bean class in which the message-driven bean instances can access the methods of the `javax.ejb.MessageDrivenContext` interface, the `java:comp/env` environment naming context, resource managers, `TimerService` and `Timer` methods, the `EntityManager` and `EntityManagerFactory` methods, and other enterprise beans.

If a message-driven bean instance attempts to invoke a method of the `MessageDrivenContext` interface, and the access is not allowed in Table 4, the container must throw and log the `java.lang.IllegalStateException`.

If a message-driven bean instance attempts to invoke a method of the `TimerService` or `Timer` interface, and the access is not allowed in Table 4, the container must throw the `java.lang.IllegalStateException`.

If a bean instance attempts to access a resource manager, an enterprise bean, or an entity manager or entity manager factory, and the access is not allowed in Table 4, the behavior is undefined by the EJB architecture.

Table 4 Operations Allowed in the Methods of a Message-Driven Bean

Bean method	Bean method can perform the following operations	
	Container-managed transaction demarcation	Bean-managed transaction demarcation
constructor	-	-
dependency injection methods (e.g., <code>setMessageDrivenContext</code>)	MessageDrivenContext methods: <i>lookup</i> JNDI access to <code>java:comp/env</code>	MessageDrivenContext methods: <i>lookup</i> JNDI access to <code>java:comp/env</code>
PostConstruct, Pre-Destroy lifecycle callback methods	MessageDrivenContext methods: <i>getTimerService, lookup, getContextData</i> JNDI access to <code>java:comp/env</code> EntityManagerFactory access	MessageDrivenContext methods: <i>getUserTransaction, getTimerService, lookup, getContextData</i> JNDI access to <code>java:comp/env</code> EntityManagerFactory access
message listener method, business method interceptor method	MessageDrivenContext methods: <i>getRollbackOnly, setRollbackOnly, getCallerPrincipal, isCallerInRole, getTimerService, lookup, getContextData</i> JNDI access to <code>java:comp/env</code> Resource manager access Enterprise bean access EntityManagerFactory access EntityManager access Timer service or Timer methods	MessageDrivenContext methods: <i>getUserTransaction, getCallerPrincipal, isCallerInRole, getTimerService, lookup, getContextData</i> UserTransaction methods JNDI access to <code>java:comp/env</code> Resource manager access Enterprise bean access EntityManagerFactory access EntityManager access Timer service or Timer methods
timeout callback method	MessageDrivenContext methods: <i>getRollbackOnly, setRollbackOnly, getCallerPrincipal, getTimerService, lookup, getContextData</i> JNDI access to <code>java:comp/env</code> Resource manager access Enterprise bean access EntityManagerFactory access EntityManager access Timer service or Timer methods	MessageDrivenContext methods: <i>getUserTransaction, getCallerPrincipal, getTimerService, lookup, getContextData</i> UserTransaction methods JNDI access to <code>java:comp/env</code> Resource manager access Enterprise bean access EntityManagerFactory access EntityManager access Timer service or Timer methods

Additional restrictions:

- The `getRollbackOnly` and `setRollbackOnly` methods of the `MessageDrivenContext` interface should be used only in the message-driven bean methods that execute in the context of a transaction. The container must throw the `java.lang.IllegalStateException` if the methods are invoked while the instance is not associated with a transaction.

The reasons for disallowing operations in Table 4:

- Invoking the `getRollbackOnly` and `setRollbackOnly` methods is disallowed in the message-driven bean methods for which the container does not have a meaningful transaction context, and for all message-driven beans with bean-managed transaction demarcation.
- The `UserTransaction` interface is unavailable to message-driven beans with container-managed transaction demarcation.
- Invoking `getEJBHome` or `getEJBLocalHome` is disallowed in message-driven bean methods because there are no `EJBHome` or `EJBLocalHome` objects for message-driven beans. The container must throw and log the `java.lang.IllegalStateException` if these methods are invoked.

5.6 The Responsibilities of the Bean Provider

This section describes the responsibilities of the message-driven Bean Provider to ensure that a message-driven bean can be deployed in any EJB container.

5.6.1 Classes and Interfaces

The message-driven Bean Provider is responsible for providing the following class files:

- Message-driven bean class.
- Interceptor classes, if any.

5.6.2 Message-Driven Bean Class

The following are the requirements for the message-driven bean class:

- The class must implement, directly or indirectly, the message listener interface required by the messaging type that it supports or the methods of the message listener interface. In the case of JMS, this is the `javax.jms.MessageListener` interface.
- The class must be defined as `public`, must not be `final`, and must not be `abstract`. The class must be a top level class.

- The class must have a `public` constructor that takes no arguments. The container uses this constructor to create instances of the message-driven bean class.
- The class must not define the `finalize` method.

Optionally:

- The class may implement, directly or indirectly, the `javax.ejb.MessageDrivenBean` interface.
- The class may implement, directly or indirectly, the `javax.ejb.TimerObject` interface.
- The class may implement the `ejbCreate` method.

The message-driven bean class may have superclasses and/or superinterfaces. If the message-driven bean has superclasses, the methods of the message listener interface, lifecycle callback interceptor methods, timeout callback methods, the `ejbCreate` method, and the methods of the `MessageDrivenBean` interface may be defined in the message-driven bean class or in any of its superclasses. A message-driven bean class must not have a superclass that is itself a message-driven bean class.

The message-driven bean class is allowed to implement other methods (for example, helper methods invoked internally by the message listener method) in addition to the methods required by the EJB specification.

5.6.3 Message-Driven Bean Superclasses

A message-driven bean class is permitted to have superclasses that are themselves message-driven bean classes. However, there are no special rules that apply to the processing of annotations or the deployment descriptor for this case. For the purposes of processing a particular message-driven bean class, all superclass processing is identical regardless of whether the superclasses are themselves message-driven bean classes. In this regard, the use of message-driven bean classes as superclasses merely represents a convenient use of *implementation inheritance*, but does not have *component inheritance* semantics.

5.6.4 Message Listener Method

The message-driven bean class must define the message listener methods. The signature of a message listener method must follow these rules:

The method must be declared as `public`.

The method must not be declared as `final` or `static`.

5.6.5 Lifecycle Callback Interceptor Methods

`PostConstruct` and `PreDestroy` lifecycle callback interceptor methods may be defined for message-driven beans. If `PrePassivate` or `PostActivate` lifecycle callbacks are defined, they are ignored.^[28]

Compatibility Note: If the `PostConstruct` lifecycle callback interceptor method is the `ejbCreate` method, or if the `PreDestroy` lifecycle callback interceptor method is the `ejbRemove` method, these callback methods must be implemented on the bean class itself (or on its superclasses). Except for these cases, the method names can be arbitrary, but must not start with “`ejb`” to avoid conflicts with the callback methods defined by the `javax.ejb.EnterpriseBean` interfaces.

Lifecycle callback interceptor methods may be defined on the bean class and/or on an interceptor class of the bean. Rules applying to the definition of lifecycle callback interceptor methods are defined in Section 12.5, “Interceptors for LifeCycle Event Callbacks”.

5.7 The Responsibilities of the Container Provider

This section describes the responsibilities of the Container Provider to support a message-driven bean. The Container Provider is responsible for providing the deployment tools, and for managing the message-driven bean instances at runtime.

Because the EJB specification does not define the API between deployment tools and the container, we assume that the deployment tools are provided by the Container Provider. Alternatively, the deployment tools may be provided by a different vendor who uses the container vendor’s specific API.

5.7.1 Generation of Implementation Classes

The deployment tools provided by the container are responsible for the generation of additional classes when the message-driven bean is deployed. The tools obtain the information that they need for generation of the additional classes by introspecting the classes and interfaces provided by the enterprise Bean Provider and by examining the message-driven bean’s deployment descriptor.

The deployment tools may generate a class that mixes some container-specific code with the message-driven bean class. This code may, for example, help the container to manage the bean instances at runtime. Subclassing, delegation, and code generation can be used by the tools.

5.7.2 Deployment of JMS Message-Driven Beans

The Container Provider must support the deployment of a JMS message-driven bean as the consumer of a JMS queue or a durable subscription.

[28] This might result from the use of default interceptor classes, for example.

5.7.3 Request/Response Messaging Types

If the message listener supports a request/response messaging type, it is the container's responsibility to deliver the message response.

5.7.4 Non-reentrant Instances

The container must ensure that only one thread can be executing an instance at any time.

5.7.5 Transaction Scoping, Security, Exceptions

The container must follow the rules with respect to transaction scoping, security checking, and exception handling, as described in Chapters 13, 17, and 14.

Chapter 6 Persistence

The model for persistence and object/relational mapping was considerably revised and enhanced in the Enterprise JavaBeans 3.0 release. The contracts and requirements for persistent entities are now defined by an independent specification, the “*Java Persistence API*” [2], which also contains the full specification of the Java Persistence query language and the metadata for object/relational mapping.

Chapters 7, 8, and 10 of this specification document the client view of entity beans under the earlier EJB 2.1 programming model, the contracts for EJB 2.1 Entity Beans with Container-Managed Persistence, and the contracts for EJB 2.1 Entity Beans with Bean-Managed Persistence respectively.

Client View of an EJB 2.1 Entity Bean

This chapter describes the client view of an EJB 2.1 entity bean. It is actually a contract fulfilled by the container in which the entity bean is deployed. Only the business methods are supplied by the enterprise bean itself.

Although the client view of the deployed entity beans is provided by classes implemented by the container, the container itself is transparent to the client.

The contents of this chapter apply only to entities as defined in the Enterprise JavaBeans 2.1 specification[3]. The client view of a persistent entity is described in the document “*Java Persistence API*” [2].

The EJB 2.1 Entity Bean Contracts have been proposed for future removal. See Section 2.7 for more details.

7.1 Overview

For a client, an entity bean is a component that represents an object-oriented view of some entities stored in a persistent storage, such as a database, or entities that are implemented by an existing enterprise application.

The client of an entity bean may be a local client or the client may be a remote client.

This section provides an overview of the entity bean client view that is independent of whether the client is a remote client or a local client. The differences between remote clients and local clients are discussed in the following sections.

From its creation until its destruction, an entity object lives in a container. Transparently to the client, the container provides security, concurrency, transactions, persistence, and other services for the entity objects that live in the container. The container is transparent to the client—there is no API that a client can use to manipulate the container.

Multiple clients can access an entity object concurrently. The container in which the entity bean is deployed properly synchronizes access to the entity object's state using transactions.

Each entity object has an identity which, in general, survives a crash and restart of the container in which the entity object has been created. The object identity is implemented by the container with the cooperation of the enterprise bean class.

Multiple enterprise beans can be deployed in a container. For each entity bean deployed in a container, the container provides a class that implements a home interface for the entity bean. This interface allows the client to create, find, and remove entity objects within the enterprise bean's home as well as to execute home business methods, which are not specific to a particular entity bean object. A client can obtain the entity bean's home interface through dependency injection, or the client can look up the entity bean's home interface through JNDI. It is the responsibility of the container to make the entity bean's home interface available in the JNDI name space.

A client view of an entity bean is independent of the implementation of the entity bean and its container. This ensures that a client application is portable across all container implementations in which the entity bean might be deployed.

7.2 Remote Clients

A remote client accesses an entity bean through the entity bean's remote and remote home interfaces. The remote and remote home interfaces of the entity bean provide the remote client view.

The remote client view of an entity bean is location independent. A client running in the same JVM as an entity bean instance uses the same API to access the entity bean as a client running in a different JVM on the same or different machine.

The container provides classes that implement the entity bean's remote and remote home interfaces. The objects that implement the remote home and remote objects are remote Java objects, and are accessible from a client through the standard Java™ APIs for remote object invocation [6].

A remote client of an entity object can be another enterprise bean deployed in the same or different container or can be an arbitrary Java program, such as an application, applet, or servlet. The remote client view of an entity bean can also be mapped to non-Java client environments, such as CORBA clients not written in the Java programming language.

7.3 Local Clients

Entity beans may also have local clients. A local client is a client that is collocated with the entity bean and which may be tightly coupled to the bean.

Unlike the remote client view, the local client view of an entity bean is not location independent. The local client view requires the collocation in the same JVM of both the local client and the entity bean that provides the local client view. The local client view therefore does not provide the location transparency provided by the remote client view.

A local client accesses an entity bean through the entity bean's local home and local component interfaces. The container provides classes that implement the entity bean's local home and local component interfaces. The objects that implement the local home and local component interfaces are local Java objects.

The arguments of the methods of the local component interface and local home interface are passed by reference^[29]. Such entity beans and their clients must be coded to assume that the state of any Java object that is passed as an argument or result is potentially shared by caller and callee.

A local client of an entity bean may be a session bean, a message-driven bean, another entity bean, or a web-tier component.

The choice between the use of a local or remote programming model is a design decision that the Bean Provider makes when developing the entity bean application. In general, however, entity beans are intended to be used with local clients. While it is possible to provide both a client view and a local client view for an entity bean with container-managed persistence, it is more likely that the entity bean will be designed with the local view in mind.

Entity beans that have container-managed relationships with other entity beans, as described in Chapter 8, "EJB 2.1 Entity Bean Component Contract for Container-Managed Persistence", must be accessed in the same local scope as those related beans, and therefore typically provide a local client view. In order to be the target of a container-managed relationship, an entity bean with container-managed persistence must provide a local component interface.

7.4 EJB Container

An EJB container (container for short) is a system that functions as a runtime container for enterprise beans.

[29] More literally, references are passed by value in the JVM: an argument variable of primitive type holds a value of that primitive type; an argument variable of a reference type hold a reference to the object. See [28].

Multiple enterprise beans can be deployed in a single container. For each entity bean deployed in a container, the container provides a home interface that allows the client to create, find, and remove entity objects that belong to the entity bean. The home interface may also provide home business methods, which are not specific to a particular entity bean object. The container makes the entity bean's home interface (defined by the Bean Provider and implemented by the Container Provider) available in the JNDI name space for clients.

An EJB server may host one or multiple EJB containers. The containers are transparent to the client: there is no client-level API to manipulate the container.

7.4.1 Locating an Entity Bean's Home Interface

A client obtains an entity bean's home interface through dependency injection, or the client locates an entity bean's home interface using JNDI. A client's JNDI name space may be configured to include the home interfaces of enterprise beans deployed in multiple EJB containers located on multiple machines on a network. The actual location of an EJB container is, in general, transparent to the client.

For example, the local home interface for the `Account` entity bean can be located using the following code segment:

```
Context initialContext = new InitialContext();
AccountHome accountHome = (AccountHome)
    initialContext.lookup("java:comp/env/ejb/accounts");
```

If dependency injection were used, the home interface could be obtained as follows:

```
@EJB AccountHome accountHome;
```

7.4.2 What a Container Provides

The following diagram illustrates the view that a container provides to the client of the entity beans deployed in the container. Note that a client may be a local client of some entity beans and a remote client of others.

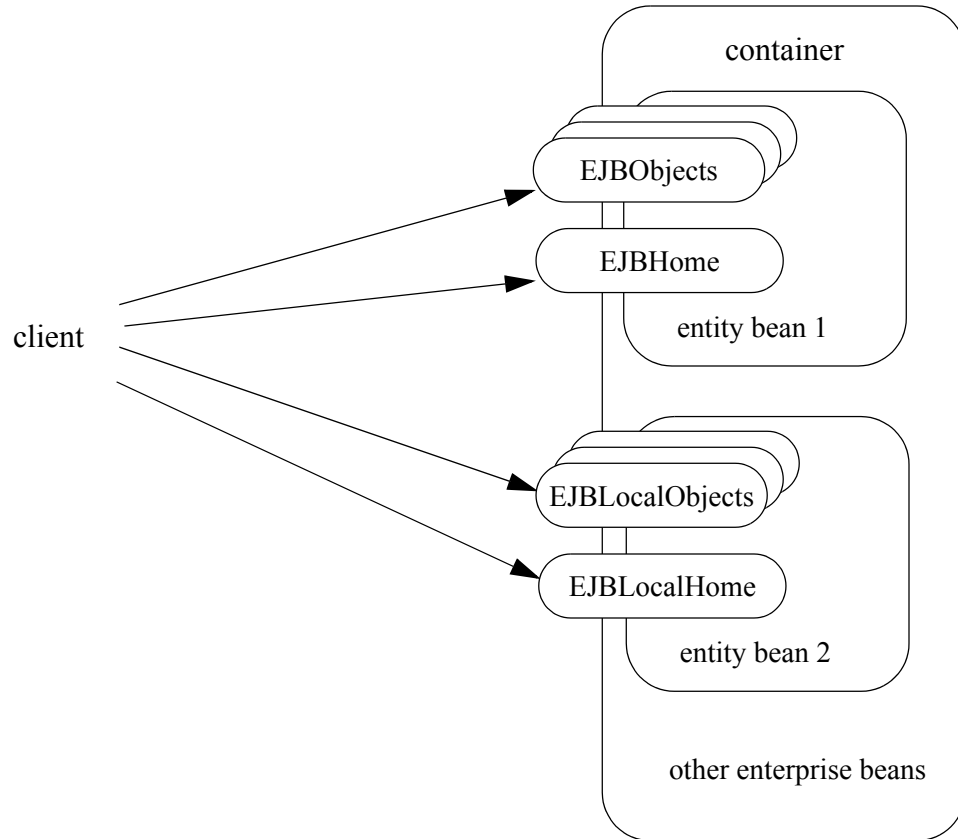
Figure 10 Client View of Entity Beans Deployed in a Container

7.5 Entity Bean's Remote Home Interface

This section is specific to entity beans that provide a remote client view. Local home interfaces are described in Section 7.6.

The container provides the implementation of the remote home interface for each entity bean deployed in the container that defines a remote home interface. An object that implements an entity bean's remote home interface is called an **EJBHome** object.

The entity bean's remote home interface allows a client to do the following:

- Create new entity objects within the home.
- Find existing entity objects within the home.

- Remove an entity object from the home.
- Execute a home business method.
- Get the `javax.ejb.EJBMetaData` interface for the entity bean. The `javax.ejb.EJBMetaData` interface is intended to allow application assembly tools to discover the metadata information about the entity bean. The metadata information allows loose client/server binding and scripting.
- Obtain a handle for the home interface. The home handle can be serialized and written to stable storage. Later, possibly in a different JVM, the handle can be deserialized from stable storage and used to obtain a reference to the home interface.

An entity bean's remote home interface must extend the `javax.ejb.EJBHome` interface and follow the standard rules for Java programming language remote interfaces.

7.5.1 Create Methods

An entity bean's remote home interface can define zero or more `create<METHOD>` methods, one for each way to create an entity object. The arguments of the `create` methods are typically used to initialize the state of the created entity object. The name of each `create` method starts with the prefix "create".

The return type of a `create<METHOD>` method on the remote home interface is the entity bean's remote interface.

The `throws` clause of every `create<METHOD>` method on the remote home interface includes the `java.rmi.RemoteException` and the `javax.ejb.CreateException`. It may include additional application-level exceptions.

The following home interface illustrates three possible `create` methods:

```
public interface AccountHome extends javax.ejb.EJBHome {
    public Account create(String firstName, String lastName,
        double initialBalance)
        throws RemoteException, CreateException;
    public Account create(String accountNumber,
        double initialBalance)
        throws RemoteException, CreateException,
        LowInitialBalanceException;
    public Account createLargeAccount(String firstname,
        String lastname, double initialBalance)
        throws RemoteException, CreateException;
    ...
}
```

The following example illustrates how a client creates a new entity object:

```
AccountHome accountHome = ...;  
Account account = accountHome.create("John", "Smith", 500.00);
```

7.5.2 Finder Methods

An entity bean's remote home interface defines one or more finder methods^[30], one for each way to find an entity object or collection of entity objects within the home. The name of each finder method starts with the prefix "find", such as `findLargeAccounts`. The arguments of a finder method are used by the entity bean implementation to locate the requested entity objects. The return type of a finder method on the remote home interface must be the entity bean's remote interface, or a type representing a collection of objects that implement the entity bean's remote interface (see Subsections 8.5.7 and 10.1.9).

The `throws` clause of every finder method on the remote home interface includes the `java.rmi.RemoteException` and the `javax.ejb.FinderException` exceptions.

The remote home interface includes the `findByPrimaryKey(primaryKey)` method, which allows a client to locate an entity object using a primary key. The name of the method is always `findByPrimaryKey`; it has a single argument that is the same type as the entity bean's primary key type, and its return type is the entity bean's remote interface. There is a unique `findByPrimaryKey(primaryKey)` method for an entity bean on its remote home interface; this method must not be overloaded. The implementation of the `findByPrimaryKey(primaryKey)` method must ensure that the entity object exists.

The following example shows the `findByPrimaryKey` method:

```
public interface AccountHome extends javax.ejb.EJBHome {  
    ...  
    public Account findByPrimaryKey(String AccountNumber)  
        throws RemoteException, FinderException;  
}
```

The following example illustrates how a client uses the `findByPrimaryKey` method:

```
AccountHome = ...;  
Account account = accountHome.findByPrimaryKey("100-3450-3333");
```

[30] The `findByPrimaryKey` method is mandatory for the remote home interface of all entity beans.

7.5.3 Remove Methods

The `javax.ejb.EJBHome` interface defines several methods that allow the client to remove an entity object.

```
public interface EJBHome extends Remote {
    void remove(Handle handle) throws RemoteException,
        RemoveException;
    void remove(Object primaryKey) throws RemoteException,
        RemoveException;
}
```

After an entity object has been removed, subsequent attempts to access the entity object by a remote client result in the `java.rmi.NoSuchObjectException`.

7.5.4 Home Methods

An entity bean's remote home interface may define one or more home methods. Home methods are methods that the Bean Provider supplies for business logic that is not specific to an entity bean instance.

Home methods on the remote home interface can have arbitrary method names, but they must not start with "create", "find", or "remove". The arguments of a home method are used by the entity bean implementation in computations that do not depend on a specific entity bean instance. The method arguments and return value types of a home method on the remote home interface must be legal types for RMI-IIOP.

The `throws` clause of every home method on the remote home interface includes the `java.rmi.RemoteException`. It may also include additional application-level exceptions.

The following example shows two home methods:

```
public interface EmployeeHome extends javax.ejb.EJBHome {
    ...
    // this method returns a living index depending on
    // the state and the base salary of an employee:
    // the method is not specific to an instance
    public float livingIndex(String state, float Salary)
        throws RemoteException;

    // this method adds a bonus to all of the employees
    // based on a company profit-sharing index
    public void addBonus(float company_share_index)
        throws RemoteException, ShareIndexOutOfRangeException;

    ...
}
```

7.6 Entity Bean's Local Home Interface

The container provides the implementation of the local home interface for each entity bean deployed in the container that defines a local home interface. An object that implements an entity bean's local home interface is called an **EJBLocalHome** object.

The entity bean's local home interface allows a local client to do the following:

- Create new entity objects within the home.
- Find existing entity objects within the home.
- Remove an entity object from the home.
- Execute a home business method.

An entity bean's local home interface must extend the `javax.ejb.EJBLocalHome` interface.

7.6.1 Create Methods

An entity bean's local home interface can define zero or more `create<METHOD>` methods, one for each way to create an entity object. The arguments of the `create` methods are typically used to initialize the state of the created entity object. The name of each `create` method starts with the prefix “`create`”.

The return type of a `create<METHOD>` method on the local home interface is the entity bean's local interface.

The `throws` clause of every `create<METHOD>` method on the local home interface includes the `javax.ejb.CreateException`. It may include additional application-level exceptions. It must not include the `java.rmi.RemoteException`.

The following local home interface illustrates three possible `create` methods:

```
public interface AccountHome extends javax.ejb.EJBLocalHome {
    public Account create(String firstName, String lastName,
        double initialBalance)
        throws CreateException;
    public Account create(String accountNumber,
        double initialBalance)
        throws CreateException, LowInitialBalanceException;
    public Account createLargeAccount(String firstname,
        String lastname, double initialBalance)
        throws CreateException;
    ...
}
```

The following example illustrates how a client creates a new entity object:

```
AccountHome accountHome = ...;
Account account = accountHome.create("John", "Smith", 500.00);
```

7.6.2 Finder Methods

An entity bean's local home interface defines one or more finder methods^[31], one for each way to find an entity object or collection of entity objects within the home. The name of each finder method starts with the prefix "find", such as `findLargeAccounts`. The arguments of a finder method are used by the entity bean implementation to locate the requested entity objects. The return type of a finder method on the local home interface must be the entity bean's local interface, or a type representing a collection of objects that implement the entity bean's local interface (see Subsections 8.5.7 and 10.1.9).

The `throws` clause of every finder method on the local home interface includes the `javax.ejb.FinderException`. The `throws` clause must not include the `java.rmi.RemoteException`.

The local home interface includes the `findByPrimaryKey(primaryKey)` method, which allows a client to locate an entity object using a primary key. The name of the method is always `findByPrimaryKey`; it has a single argument that is the same type as the entity bean's primary key type, and its return type is the entity bean's local interface. There is a unique `findByPrimaryKey(primarykey)` method for an entity bean on its local home interface; this method must not be overloaded. The implementation of the `findByPrimaryKey` method must ensure that the entity object exists.

The following example shows the `findByPrimaryKey` method:

```
public interface AccountHome extends javax.ejb.EJBLocalHome {
    ...
    public Account findByPrimaryKey(String AccountNumber)
        throws FinderException;
}
```

The following example illustrates how a client uses the `findByPrimaryKey` method:

```
AccountHome = ...;
Account account = accountHome.findByPrimaryKey("100-3450-3333");
```

7.6.3 Remove Methods

The `javax.ejb.EJBLocalHome` interface defines the `remove` method to allow the client to remove an entity object.

```
public interface EJBLocalHome {
    void remove(Object primaryKey) throws RemoveException,
        EJBException;
}
```

[31] The `findByPrimaryKey` method is mandatory for the local home interface of all Entity Beans.

After an entity object has been removed, subsequent attempts to access the local entity object by the local client result in the `javax.ejb.NoSuchObjectLocalException`.

7.6.4 Home Methods

An entity bean's local home interface may define one or more home methods. Home methods are methods that the Bean Provider supplies for business logic that is not specific to an entity bean instance.

Home methods can have arbitrary method names, but they must not start with "create", "find", or "remove". The arguments of a home method are used by the entity bean implementation in computations that do not depend on a specific entity bean instance.

The `throws` clause of a home method on the local home interface may include additional application-level exceptions. It must not include the `java.rmi.RemoteException`.

The following example shows two home methods:

```
public interface EmployeeHome extends javax.ejb.EJBLocalHome {
    ...
    // this method returns a living index depending on
    // the state and the base salary of an employee:
    // the method is not specific to an instance
    public float livingIndex(String state, float Salary);

    // this method adds a bonus to all of the employees
    // based on a company profit sharing index
    public void addBonus(float company_share_index)
        throws ShareIndexOutOfRangeException;
    ...
}
```

7.7 Entity Object's Life Cycle

This section describes the life cycle of an entity object from the perspective of a client.

The following diagram illustrates a client's point of view of an entity object life cycle. (The term "referenced" in the diagram means that the client program has a reference to the entity object's remote or local interface.)

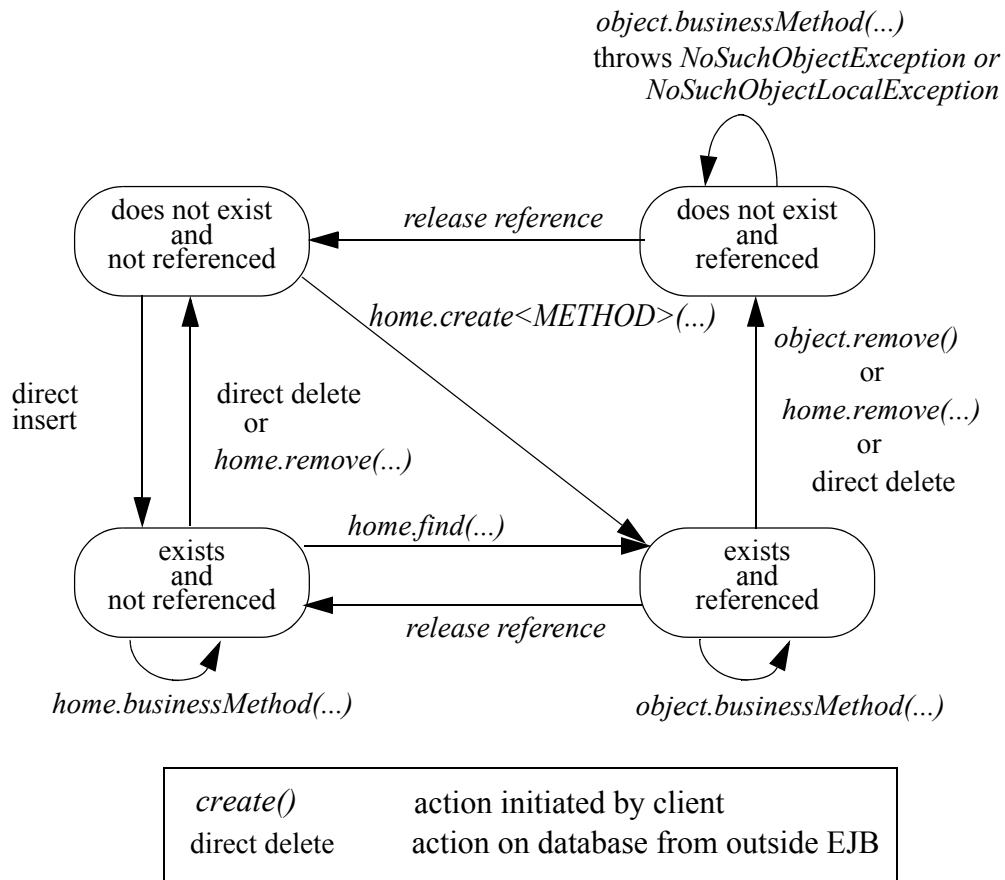
Figure 11 Client View of Entity Object Life Cycle

An entity object does not exist until it is created. Until it is created, it has no identity. After it is created, it has identity. A client creates an entity object using the entity bean's home interface, whose class is implemented by the container. When a client creates an entity object, the client obtains a reference to the newly created entity object.

In an environment with legacy data, entity objects may "exist" before the container and entity bean are deployed. In addition, an entity object may be "created" in the environment via a mechanism other than by invoking a `create<METHOD>` method of the home interface (e.g. by inserting a database record), but still may be accessible via the finder methods. Also, an entity object may be deleted directly using other means than the `remove` operation (e.g. by deletion of a database record). The "direct insert" and "direct delete" transitions in the diagram represent such direct database manipulation.

All entity objects are considered persistent objects. The lifetime of an entity object is not limited by the lifetime of the Java Virtual Machine process in which the entity bean instance executes. While a crash of the Java Virtual Machine may result in a rollback of current transactions, it does not destroy previously created entity objects nor invalidate the references to the home and component interfaces held by clients.

Multiple clients can access the same entity object concurrently. Transactions are used to isolate the clients' work from each other.

7.7.1 References to Entity Object Remote Interfaces

A client can get a reference to an existing entity object's remote interface in any of the following ways:

- Receive the reference as a parameter in a method call (input parameter or result).
- Find the entity object using a finder method defined in the entity bean's remote home interface.
- Obtain the reference from the entity object's handle. (See Section 7.11).

A client that has a reference to an entity object's remote interface can do any of the following:

- Invoke business methods on the entity object through the remote interface.
- Obtain a reference to the enterprise bean's remote home interface.
- Pass the reference as a parameter or return value of a method call.
- Obtain the entity object's primary key.
- Obtain the entity object's handle.
- Remove the entity object.

All references to an entity object that does not exist are invalid. All attempted invocations on an entity object that does not exist result in an `java.rmi.NoSuchObjectException` being thrown.

7.7.2 References to Entity Object Local Interfaces

A local client can get a reference to an existing entity object's local interface in any of the following ways:

- Receive the reference as a result of a method call.
- Find the entity object using a finder method defined in the entity bean's local home interface.

A local client that has a reference to an entity object's local interface can do any of the following:

- Invoke business methods on the entity object through the local interface.

- Obtain a reference to the enterprise bean's local home interface.
- Pass the reference as a parameter or return value of a local method call.
- Obtain the entity object's primary key.
- Remove the entity object.

All local references to an entity object that does not exist are invalid. All attempted invocations on an entity object that does not exist result in a `javax.ejb.NoSuchObjectLocalException` being thrown.

A local interface type must not be passed as an argument or result of a remote interface method.

7.8 Primary Key and Object Identity

Every entity object has a unique identity within its home. If two entity objects have the same home and the same primary key, they are considered identical.

The Enterprise JavaBeans architecture allows a primary key class to be any class that is a legal Value Type in RMI-IIOP, subject to the restrictions defined in Subsections 8.6.13 and 10.2.12. The primary key class may be specific to an entity bean class (i.e., each entity bean class may define a different class for its primary key, but it is possible that multiple entity beans use the same primary key class).

A client that holds a reference to an entity object's component interface can determine the entity object's identity within its home by invoking the `getPrimaryKey` method on the reference.

The object identity associated with a reference does not change over the lifetime of the reference. (That is, `getPrimaryKey` always returns the same value when called on the same entity object reference). If an entity object has both a remote home interface and a local home interface, the result of invoking the `getPrimaryKey` method on a reference to the entity object's remote interface and on a reference to the entity object's local interface is the same.

A client can test whether two entity object references refer to the same entity object by using the `isIdentical` method. Alternatively, if a client obtains two entity object references from the same home, it can determine if they refer to the same entity by comparing their primary keys using the `equals` method.

The following code illustrates using the `isIdentical` method to test if two object references refer to the same entity object:

```
Account acc1 = ...;
Account acc2 = ...;

if (acc1.isIdentical(acc2)) {
    // acc1 and acc2 are the same entity object
} else {
    // acc1 and acc2 are different entity objects
}
```

A client that knows the primary key of an entity object can obtain a reference to the entity object by invoking the `findByPrimaryKey(key)` method on the entity bean's home interface.

Note that the Enterprise JavaBeans architecture does not specify "object equality" (i.e. use of the `==` operator) for entity object references. The result of comparing two object references using the Java programming language `Object.equals(Object obj)` method is unspecified. Performing the `Object.hashCode()` method on two object references that represent the entity object is not guaranteed to yield the same result. Therefore, a client should always use the `isIdentical` method to determine if two entity object references refer to the same entity object.

Note that the use of `isIdentical` for the comparison of object references applies to the implementation of the methods of the `java.util.Collection` API as well.

7.9 Entity Bean's Remote Interface

A client can access an entity object through the entity bean's remote interface. An entity bean's remote interface must extend the `javax.ejb.EJBObject` interface. A remote interface defines the business methods that are callable by remote clients.

The following example illustrates the definition of an entity bean's remote interface:

```
public interface Account extends javax.ejb.EJBObject {
    void debit(double amount)
        throws java.rmi.RemoteException,
            InsufficientBalanceException;
    void credit(double amount)
        throws java.rmi.RemoteException;
    double getBalance()
        throws java.rmi.RemoteException;
}
```

The `javax.ejb.EJBObject` interface defines the methods that allow the client to perform the following operations on an entity object's reference:

- Obtain the remote home interface for the entity object.
- Remove the entity object.

- Obtain the entity object's handle.
- Obtain the entity object's primary key.

The container provides the implementation of the methods defined in the `javax.ejb.EJBObject` interface. Only the business methods are delegated to the instances of the enterprise bean class.

Note that the entity object does not expose the methods of the `javax.ejb.EnterpriseBean` interface to the client. These methods are not intended for the client—they are used by the container to manage the enterprise bean instances.

7.10 Entity Bean's Local Interface

A local client can access an entity object through the entity bean's local interface. An entity bean's local interface must extend the `javax.ejb.EJBLocalObject` interface. A local interface defines the business methods that are callable by local clients.

The following example illustrates the definition of an entity bean's local interface:

```
public interface Account extends javax.ejb.EJBLocalObject {
    void debit(double amount)
        throws InsufficientBalanceException;
    void credit(double amount);
    double getBalance();
}
```

Note that the methods of the entity bean's local interface must not throw the `java.rmi.RemoteException`.

The `javax.ejb.EJBLocalObject` interface defines the methods that allow the local client to perform the following operations on an entity object's local reference:

- Obtain the local home interface for the entity object.
- Remove the entity object.
- Obtain the entity object's primary key.

The container provides the implementation of the methods defined in the `javax.ejb.EJBLocalObject` interface. Only the business methods are delegated to the instances of the enterprise bean class.

Note that the entity object does not expose the methods of the `javax.ejb.EntityBean` or the optional `javax.ejb.TimedObject` interface to the local client. These methods are not intended for the local client—they are used by the container to manage the enterprise bean instances.

7.11 Entity Bean's Handle

An entity object's handle is an object that identifies the entity object on a network. A client that has a reference to an entity object's remote interface can obtain the entity object's handle by invoking the `getHandle` method on the remote interface. The `getHandle` method is only available on the remote interface.

Since a handle class extends `java.io.Serializable`, a client may serialize the handle. The client may use the serialized handle later, possibly in a different process or even system, to re-obtain a reference to the entity object identified by the handle.

The client code must use the `javax.rmi.PortableRemoteObject.narrow` method to convert the result of the `getEJBObject` method invoked on a handle to the entity bean's remote interface type.

The lifetime and scope of a handle is specific to the handle implementation. At the minimum, a program running in one JVM must be able to obtain and serialize the handle, and another program running in a different JVM must be able to deserialize it and re-create an object reference. An entity handle is typically implemented to be usable over a long period of time—it must be usable at least across a server restart.

Containers that store long-lived entities will typically provide handle implementations that allow clients to store a handle for a long time (possibly many years). Such a handle will be usable even if parts of the technology used by the container (e.g. ORB, DBMS, server) have been upgraded or replaced while the client has stored the handle. Support for this "quality of service" is not required by the EJB specification.

An EJB container is not required to accept a handle that was generated by another vendor's EJB container.

The use of a handle is illustrated by the following example:

```
// A client obtains a handle of an account entity object and
// stores the handle in stable storage.
//
ObjectOutputStream stream = ...;
Account account = ...;
Handle handle = account.getHandle();
stream.writeObject(handle);

// A client can read the handle from stable storage, and use the
// handle to resurrect an object reference to the
// account entity object.
//
ObjectInputStream stream = ...;
Handle handle = (Handle) stream.readObject();
Account account = (Account) javax.rmi.PortableRemoteObject.narrow(
    handle.getEJBObject(), Account.class);
account.debit(100.00);
```

A handle is not a capability, in the security sense, that would automatically grant its holder the right to invoke methods on the object. When a reference to an object is obtained from a handle, and then a method on the object is invoked, the container performs the usual access checks based on the caller's principal.

7.12 Entity Home Handles

The EJB specification allows a client to obtain a handle for the remote home interface. The client can use the home handle to store a reference to an entity bean's remote home interface in stable storage, and re-create the reference later. This handle functionality may be useful to a client that needs to use the remote home interface in the future, but does not know the JNDI name of the remote home interface.

A handle to a remote home interface must implement the `javax.ejb.HomeHandle` interface.

The client code must use the `javax.rmi.PortableRemoteObject.narrow` method to convert the result of the `getEJBHome` method invoked on a handle to the home interface type.

The lifetime and scope of a handle is specific to the handle implementation. At a minimum, a program running in one JVM must be able to serialize the handle, and another program running in a different JVM must be able to deserialize it and re-create an object reference. An entity handle is typically implemented to be usable over a long period of time—it must be usable at least across a server restart.

7.13 Type Narrowing of Object References

A client program that is intended to be interoperable with all compliant EJB container implementations must use the `javax.rmi.PortableRemoteObject.narrow` method to perform type-narrowing of the client-side representations of the remote home and remote interfaces.

Note: Programs that use the cast operator to narrow the remote and remote home interfaces are likely to fail if the container implementation uses RMI-IIOP as the underlying communication transport.

EJB 2.1 Entity Bean Component Contract for Container-Managed Persistence

The EJB 2.1 entity bean component contract for container-managed persistence is the contract between an entity bean and its container. It defines the life cycle of the entity bean instances, the model for method delegation of the business methods invoked by the client, and the model for the management of the entity bean's persistent state and relationships. The main goal of this contract is to ensure that an entity bean component using container-managed persistence is portable across all compliant EJB containers.

This chapter defines the Enterprise Bean Provider's view of this contract and responsibilities of the Container Provider for managing the life cycle of the enterprise bean instances and their persistent state and relationships.

The contents of this chapter apply only to entity bean components with container-managed persistence as defined in the Enterprise JavaBeans 2.1 specification [3]. The contracts for persistent entities are described in the document "*Java Persistence API*" [2].

The EJB 2.1 Entity Bean Contracts have been proposed for future removal. See Section 2.7 for more details.

Note that use of dependency injection, interceptors, and Java language metadata annotations is not supported for EJB 2.1 entity beans.

8.1 Overview

In accordance with the architecture for container-managed persistence, the Bean Provider develops a set of entity beans for an application, and determines the relationships among them. The Bean Provider designs an abstract persistence schema for each entity bean, which defines its container-managed fields and relationships, and determines the methods for accessing them. The entity bean instance accesses its container-managed fields and relationships at runtime by means of the methods defined for its abstract persistence schema.

The abstract persistence schema is specified in the deployment descriptor that is produced by the Bean Provider. The Deployer, using the Container Provider's tools, determines how the persistent fields and relationships defined by the abstract persistence schema are mapped to a database or other persistent store, and generates the necessary additional classes and interfaces that enable the container to manage the persistent fields and relationships of the entity bean instances at runtime.

This chapter describes the component contract for an EJB 2.1 entity bean with container-managed persistence, and how data independence is maintained between the entity bean instance and its representation in the persistent store. It describes this contract from the viewpoints of both the Bean Provider and the container.

8.2 Container-Managed Entity Persistence and Data Independence

The EJB component model provides a separation between the client view of a bean (as presented by its home and component interfaces) and the entity bean class (which provides the implementation of the client view). The EJB architecture for container-managed persistence adds to this a separation between the entity bean class (as defined by the Bean Provider) and its persistent representation. The container-managed persistence architecture thus provides not only a layer of data independence between the client view of a bean as an *entity object* and the Bean Provider's internal view of the bean in terms of the entity bean instance, but also between the entity bean instance and its persistent representation. This allows an entity bean to be evolved independently from its clients, without requiring the redefinition or recompilation of those clients, and it allows an entity bean to be redeployed across different containers and different persistent data stores, without requiring the redefinition or recompilation of the entity bean class.

In container-managed persistence, unlike in bean-managed persistence, the Bean Provider does not write database access calls in the methods of the entity bean class. Instead, persistence is handled by the container at runtime. The entity Bean Provider must specify in the deployment descriptor those persistent fields and relationships for which the container must handle data access. The Bean Provider codes all persistent data access by using the accessor methods that are defined for the abstract persistence schema. The implementation of the persistent fields and relationships, as well as all data access, is deferred to the container.

It is the responsibility of the Deployer to map the abstract persistence schema of a set of interrelated entity bean classes into the physical schema used by the underlying data store (e.g., into a relational schema) by using the Container Provider's tools. The Deployer uses the deployment descriptor as input to the Container Provider's tools to perform this mapping. The Container Provider's tools are also used to generate the concrete implementation of the entity bean classes, including the code that delegates calls to the accessor methods of the entity bean class to the runtime persistent data access layer of the container.

The EJB deployment descriptor for EJB 2.1 entity beans describes *logical* relationships among entity beans. It does not provide a mechanism for specifying how the abstract persistence schema of an entity bean or of a set of interrelated entity beans is to be mapped to an underlying database. This is the responsibility of the Deployer, who, using the Container Provider's tools, uses the logical relationships that are specified in the deployment descriptor to map to the physical relationships that are specific to the underlying resource. It is the responsibility of the container to manage the mapping between the logical and physical relationships at runtime and to manage the referential integrity of the relationships.

The advantage of using container-managed persistence is that the entity bean can be logically independent of the data source in which the entity is stored. The Container Provider's tools can, for example, generate classes that use JDBC or SQLJ to access the entity state in a relational database; classes that implement access to a non-relational data source, such as an IMS database; or classes that implement function calls to existing enterprise applications. These tools are typically specific to each data source.

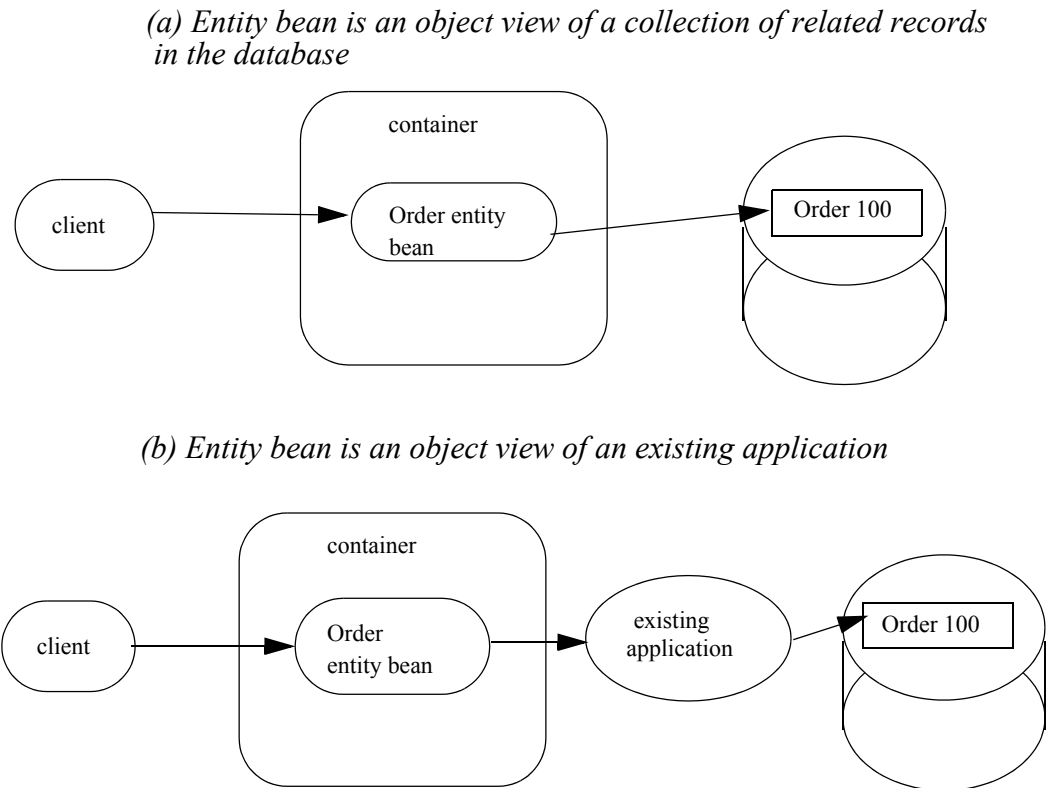
Figure 12 View of Underlying Data Sources Accessed Through Entity Bean

8.3 The Entity Bean Provider's View of Container-Managed Persistence

An entity bean implements an object view of a business entity or set of business entities stored in an underlying database or implemented by an existing enterprise application (for example, by a mainframe program or by an ERP application).

An entity bean with container-managed persistence typically consists of its entity bean class; a component interface which defines its client view business methods; a home interface which defines the create, remove, home, and finder methods of its client view; and its abstract persistence schema as specified in the deployment descriptor.

A client of an entity bean can control the life cycle of a bean by using the bean's home interface and can manipulate the bean as a business entity by using the methods defined by its component interface. The home and component interfaces of a bean define its client view.

An entity bean with container-managed persistence typically has container-managed relationships with other container-managed persistence entity beans, as defined by the `relationships` element of the deployment descriptor. The architecture for container-managed persistence thus allows the Bean Provider to implement complex applications by defining a complex abstract persistence schema encompassing multiple entity bean classes related by means of container-managed relationships.

An entity bean accesses related entity beans by means of the accessor methods for its container-managed relationship fields, which are specified by the `cmr-field` elements of its abstract persistence schema defined in the deployment descriptor. Entity bean relationships are defined in terms of the local interfaces of the related beans, and the view an entity bean presents to its related beans is defined by its local home and local interfaces. Thus, an entity bean can be the target of a relationship from another entity bean only if it has a local interface.

The Bean Provider programming an application that uses container-managed persistence typically avoids calls to the methods of the remote home and remote interfaces in favor of invoking related beans by means of the methods of their local interfaces. Unlike remote method calls, such internal method invocations are made using call-by-reference and commonly do not involve the checking of method permissions.

The Enterprise JavaBeans architecture for container-managed persistence provides great flexibility to the Bean Provider in designing an application.

For example, a group of related entity beans—`Order`, `LineItem`, and `Customer`—might all be defined as having only local interfaces, with a remotable session bean containing the business logic that drives their invocation. The individual entity beans form a coordinated whole that provides an interrelated set of services that are exposed by their several home and component interfaces. The services provided by the local network of entity beans is exposed to the remote client view through the home and remote interfaces of the session bean, which offers a coarser grained remote service.

Alternatively, a single entity bean might represent an independent, remotable business object that forms a unit of distribution that is designed to be referenced remotely by multiple enterprise beans and/or other remote clients. Such a remotable entity bean might make use of other entity beans within its local scope to further model its complex internal state. For example, an `Order` entity bean might make use of a `LineItem` entity bean internally, not exposing it to remote clients. In this case, the `Order` entity bean might define both a remote and a local component interface, where the local interface is presented only to the related entity beans, such as `LineItem`, and the remote interface is presented to session beans and/or web-tier clients.

8.3.1 The Entity Bean Provider's Programming Contract

The Bean Provider must observe the following programming contract when defining an entity bean class that uses container-managed persistence:

- The Bean Provider must define the entity bean class as an abstract class. The container provides the implementation class that is used at runtime.

- The container-managed persistent fields and container-managed relationship fields must *not* be defined in the entity bean class. From the perspective of the Bean Provider, the container-managed persistent fields and container-managed relationship fields are virtual fields only, and are accessed through get and set accessor methods. The implementation of the container-managed persistent fields and container-managed relationship fields is supplied by the container.
- The container-managed persistent fields and container-managed relationship fields must be specified in the deployment descriptor using the `cmp-field` and `cmr-field` elements respectively. The names of these fields must be valid Java identifiers and must begin with a lowercase letter, as determined by `java.lang.Character.isLowerCase`.
- The Bean Provider must define the accessor methods for the container-managed persistent fields and container-managed relationship fields as get and set methods, using the JavaBeans conventions. The implementation of the accessor methods is supplied by the container.
- The accessor methods must be public, must be abstract, and must bear the name of the container-managed persistent field (`cmp-field`) or container-managed relationship field (`cmr-field`) that is specified in the deployment descriptor, and in which the first letter of the name of the `cmp-field` or `cmr-field` has been uppercased and prefixed by “get” or “set”.
- The accessor methods for a container-managed relationship field must be defined in terms of the local interface of the related entity bean, as described in Section 8.3.2.
- The accessor methods for container-managed relationship fields for one-to-many or many-to-many relationships must utilize one of the following Collection interfaces: `java.util.Collection` or `java.util.Set`. The Collection interfaces used in relationships are specified in the deployment descriptor. The implementation of the collection classes used for the container-managed relationship fields is supplied by the container.
- An entity bean local interface type (or a collection of such) can be the type of a `cmr-field`. An entity bean local interface type (or a collection of such) cannot be the type of a `cmp-field`.
- The accessor methods for the container-managed relationship fields must not be exposed in the remote interface of an entity bean.
- The local interface types of the entity bean and of related entity beans must not be exposed through the remote interface of the entity bean.
- The collection classes that are used for container-managed relationships must not be exposed through the remote interface of the entity bean.
- Once the primary key for an entity bean has been set, the Bean Provider must not attempt to change it by use of set accessor methods on the primary key `cmp-fields`. The Bean Provider should therefore not expose the set accessor methods for the primary key `cmp-fields` in the component interface of the entity bean.
- The Bean Provider must ensure that the Java types assigned to the `cmp-fields` are restricted to the following: Java primitive types and Java serializable types.

8.3.2 The Entity Bean Provider's View of Persistent Relationships

An entity bean may have relationships with other entity beans with container-managed persistence.

Relationships may be one-to-one, one-to-many, or many-to-many relationships.

Container-managed relationships can exist only among entity beans within the same local relationship scope, as defined by the `relationships` element in the deployment descriptor. Container-managed relationships are defined in terms of the local interfaces of the related beans.

Relationships may be either bidirectional or unidirectional. If a relationship is bidirectional, it can be navigated in both directions, whereas a unidirectional relationship can be navigated in one direction only.

A unidirectional relationship is implemented with a `cmr-field` on the entity bean instance from which navigation can take place, and no related `cmr-field` on the entity bean instance that is the target of the relationship. Unidirectional relationships are typically used when the Bean Provider wishes to restrict the visibility of a relationship.

An entity bean that does not have a local interface can have only unidirectional relationships from itself to other entity beans. The lack of a local interface prevents other entity beans from having a relationship to it.

The bean developer navigates or manipulates relationships by using the `get` and `set` accessor methods for the container-managed relationship fields and the `java.util.Collection` API for collection-valued container-managed relationship fields.

The Bean Provider must consider the type and cardinality of relationships when the entity bean classes are programmed. The `get` method for a `cmr-field` must return either the local interface of the entity bean or a collection (either `java.util.Collection` or `java.util.Set`) of the same. The `set` method for the relationship must take as an argument the entity bean's local interface or a collection of the same.

8.3.3 Dependent Value Classes

A dependent value class is a concrete class that is the value of a `cmp-field`. A dependent value class may be a class that the Bean Provider wishes to use internally within an entity bean with container-managed persistence, and/or it may be a class that the Bean Provider chooses to expose through the remote (or local) interface of the entity bean.

A dependent value class can be the value of a `cmp-field`; it cannot be the value of a `cmr-field`.

The `get` accessor method for a `cmp-field` that corresponds to a dependent value class returns a *copy* of the dependent value class instance. The assignment of a dependent value class value to a `cmp-field` using the `set` accessor method causes the value to be copied to the target `cmp-field`.

A dependent value class must be serializable. The internal structure of a dependent value class is not described in the EJB deployment descriptor.

8.3.4 Remove Protocols

The Bean Provider can specify the removal of an entity object in two ways:

- By the use of a `remove` method on the entity bean's component interface or home interface.
- By the use of a `cascade-delete` specification in the deployment descriptor.

8.3.4.1 Remove Methods

When the `remove` method is invoked on an entity object, the container must invoke the entity Bean Provider's `ejbRemove` method as described in Section 8.5.3. After the Bean Provider's `ejbRemove` method returns (and prior to returning to the client), the container must remove the entity object from all relationships in which it participates, and then remove its persistent representation. ^[32]

- Once an entity has been removed from a relationship, the accessor methods for any relationships to the entity will reflect this removal. An accessor method for a one-to-one or many-to-one relationship to the entity will return null; and an accessor method for a many-to-many relationship to the entity will return a collection from which the entity object has been removed.
- The container must detect any subsequent attempt to invoke an accessor method on the removed entity object and throw the `java.rmi.NoSuchObjectException` if the client is a remote client or the `javax.ejb.NoSuchObjectLocalException` if the client is a local client. The container must detect an attempt to assign a removed entity object as the value of a cmr-field of another object (whether as an argument to a set accessor method or as an argument to a method of the `java.util.Collection` API) and throw the `java.lang.IllegalArgumentException`.

After removing the entity object from all relationships and removing its persistent representation, the container must then cascade the removal to all entity beans with which the entity had been previously in container-managed relationships for which the `cascade-delete` option was specified.

More than one relationship may be affected by the removal of an entity object, as in the following example. Once the shipping address object used by the `Order` bean has been removed, the billing address accessor method will also return null.

```
public void changeAddress()
    Address a = createAddress();
    setShippingAddress(a);
    setBillingAddress(a);
    //both relationships now reference the same entity object
    getShippingAddress().remove();
    if (getBillingAddress() == null) // it must be
        ...
    else ...
        // this is impossible....
```

[32] At this point it must appear to the application that the entity has been removed from the persistent store. If the container employs an optimistic caching strategy and defers the removal of the entity from the database (e.g., to the end of transaction), this must be invisible to the application.

The `remove` method, alone, causes only the entity on which it is invoked to be removed. It does not cause the deletion to be cascaded to other entity objects. In order for the deletion of one entity object to be automatically cascaded to another, the `cascade-delete` mechanism should be used.

8.3.4.2 Cascade-delete

The `cascade-delete` deployment descriptor element is used within a particular relationship to specify that the lifetime of one or more entity objects is dependent upon the lifetime of another entity object.

The `cascade-delete` deployment descriptor element is contained within the `ejb-relationship-role` element. The `cascade-delete` element can only be specified for an `ejb-relationship-role` element contained in an `ejb-relation` element if the *other* `ejb-relationship-role` element in the same `ejb-relation` element specifies a multiplicity of `One`. The `cascade-delete` option cannot be specified for a many-to-many relationship. The deletion of one entity object can only be cascaded to cause the deletion of other entity objects if the first entity object is in a one-to-one or one-to-many relationship with those other entity objects.

If an entity is deleted, and the `cascade-delete` deployment descriptor element is specified for a related entity bean, then the removal is cascaded to cause the removal of the related entity object or objects. As with the `remove` operation, the removal triggered by the `cascade-delete` option causes the container to invoke the `ejbRemove` method on the entity bean instance that is to be removed before the persistent representation of that entity object is removed. Once an entity has been removed from a relationship because of a cascaded delete, the accessor methods for any relationships to the entity will reflect this removal. An accessor method for a one-to-one or many-to-one relationship to the entity will return `null`; and an accessor method for a many-to-many relationship to the entity will return a collection from which the entity object has been removed. After removing the entity object from all relationships and removing its persistent representation, the container must then cascade the removal to all entity beans with which the entity had been previously been in container-managed relationships for which the `cascade-delete` option was specified.

The use of `cascade-delete` causes only the entity object or objects in the relationship for which it is specified to be deleted. It does not cause the deletion to be further cascaded to other entity objects, unless they are participants in relationship roles for which `cascade-delete` has also been specified.

8.3.5 Identity of Entity Objects

From the viewpoint of the Bean Provider, entity objects have a runtime object identity that is maintained by the container.

The container maintains the persistent identity of an entity object on the basis of its primary key.

The primary key of an entity bean may or may not be visible as one or more `cmp`-fields of the instance, depending on the way in which it is specified. The Bean Provider specifies the primary key as described in Section 8.8. Once it has been set, the Bean Provider must not attempt to change the value of a primary key field by means of a set method on its `cmp`-fields.

When a new instance of an entity bean whose primary key fields are visible in the entity bean class is created, the Bean Provider must use the `ejbCreate<METHOD>` method to set all the primary key fields of the entity bean instance before the instance can participate in a relationship, e.g. be used in a set accessor method for a `cmr-field`. The Bean Provider must not reset a primary key value by means of a set method on any of its `cmp-fields` after it has been set in the `ejbCreate<METHOD>` method. If the Bean Provider attempts to reset a primary key value, the container must throw the `java.lang.IllegalStateException`.

Note that the container's implementation of the referential integrity semantics for container-managed relationships must not cause the value of the primary key to change.

The Bean Provider should not use untrimmed or blank-padded string-valued primary key fields. Use of untrimmed primary key fields may cause comparison operations based on primary keys to fail, and may result in non-portable behavior. If untrimmed strings are used in primary key fields or other `cmp-fields`, the container or database system may trim them.

8.3.6 Semantics of Assignment for Relationships

The assignment operations for container-managed relationships have a special semantics that is determined by the referential integrity semantics for the relationship multiplicity.

In the case of a one-to-one relationship, when the Bean Provider uses a set accessor method to assign an object from a `cmr-field` in one instance to a `cmr-field` of the *same relationship type* (i.e., as defined by the `ejb-relation` and `ejb-relationship-role` deployment descriptor elements) in another instance, the object is effectively *moved* and the value of the source `cmr-field` is set to null in the same transaction context. If the argument to the set accessor method is not of the same type as the `cmr-field`, the container must throw the `java.lang.IllegalArgumentException`.

In the case of a one-to-many or many-to-many relationship, either the `java.util.Collection` API or a set accessor method may be used to manipulate the contents of a collection-valued `cmr-field`. These two approaches are discussed below.

8.3.6.1 Use of the `java.util.Collection` API to Update Relationships

The methods of the `java.util.Collection` API for the container-managed collections used for collection-valued `cmr-fields` have the usual semantics, with the following exception: the `add` and `addAll` methods applied to container-managed collections in one-to-many relationships have a special semantics that is determined by the referential integrity of one-to-many relationships.

- If the argument to the `add` method is already an element of a collection-valued relationship field of the *same relationship type* as the target collection (as defined by the `ejb-relation` and `ejb-relationship-role` deployment descriptor elements), it is removed from this first relationship and added, in the same transaction context, to the target relationship (i.e., it is effectively moved from one collection of the relationship type to the other). For example, if there is a one-to-many relationship between field offices and sales representatives, adding a sales representative to a new field office will have the effect of removing him or her from his or her current field office. If the argument to the `add` method is not an element of a collection-valued relationship of the *same relationship type*, it is simply added to the target collection and not removed from its current collection, if any.

- The `addAll` method, when applied to a target collection in a one-to-many relationship, has similar semantics, applied to the members of its collection argument individually.

Note that in the case of many-to-many relationships, adding an element or elements to the contents of a collection-valued cmr-field has no effect on the source collection, if any. For example, if there is a many-to-many relationship between customers and sales representatives, a customer can be added to the set of customers handled by a particular sales representative without affecting the set of customers handled by any other sales representative.

When the `java.util.Collection` API is used to manipulate the contents of container-managed relationship fields, the argument to any `Collection` method defined with a single `Object` parameter must be of the element type of the collection defined for the target cmr-field. The argument for any collection-valued parameter must be a `java.util.Collection` (or `java.util.Set`), all of whose elements are of the element type of the collection defined for the target cmr-field. If an argument is not of the correct type for the relationship, the container must throw the `java.lang.IllegalArgumentException`.

The Bean Provider should exercise caution when using an `Iterator` over a collection in a container-managed relationship. In particular, the Bean Provider should not modify the container-managed collection while the iteration is in progress in any way that causes elements to be added or removed, other than by the `java.util.Iterator.remove()` method. If elements are added or removed from the underlying container-managed collection used by an iterator other than by the `java.util.Iterator.remove()` method, the container should throw the `java.lang.IllegalStateException` on the next operation on the iterator.

The following example illustrates how operations on container-managed relationships that affect the contents of a collection-valued cmr-field viewed through an iterator can be avoided. Because there is a one-to-many relationship between field offices and sales representatives, adding a sales representative to a new field office causes the sales representative to be removed from the current field office.

```
Collection nySalesreps = nyOffice.getSalesreps();
Collection sfSalesreps = sfOffice.getSalesreps();

Iterator i = nySalesreps.iterator();
Salesrep salesrep;

// a wrong way to transfer the salesrep
while (i.hasNext()) {
    salesrep = (Salesrep)i.next();
    sfSalesreps.add(salesrep); // removes salesrep from nyOffice
}

// this is a correct and safe way to transfer the salesrep
while (i.hasNext()) {
    salesrep = (Salesrep)i.next();
    i.remove();
    sfSalesreps.add(salesrep);
}
```

8.3.6.2 Use of Set Accessor Methods to Update Relationships

The semantics of a set accessor method, when applied to a collection-valued cmr-field, is also determined by the referential integrity semantics associated with the multiplicity of the relationship. The identity of the collection object referenced by a cmr-field does not change when a set accessor method is executed.

In the case of a one-to-many relationship, if a collection of entity objects is assigned from a cmr-field of in one instance to a cmr-field of the same relationship type in another instance, the objects in the collection are effectively moved. The contents of the collection of the target instance are replaced with the contents of the collection of the source instance, but the *identity* of the collection object containing the instances in the relationship does not change. The source cmr-field references the same collection object as before (i.e., the identity of the collection object is preserved), but the collection is empty.

The Bean Provider can thus use the set method to move objects between the collections referenced by cmr-fields of the same relationship type in different instances. The set accessor method, when applied to a cmr-field in a one-to-many relationship thus has the semantics of the `java.util.Collection` methods `clear`, followed by `addAll`, applied to the target collection; and `clear`, applied to the source collection. It is the responsibility of the container to transfer the contents of the collection instances in the same transaction context.

Note that if the collection that is passed to the cmr setter method is an unmanaged collection (i.e., not itself the value of a collection-valued cmr-field), the same requirements apply in the case that the collection contains entity objects that already participate in a one-to-many relationship of the same relationship type as the target cmr-field.

In the following example, the telephone numbers associated with the billing address of an `Order` bean instance are transferred to the shipping address. Billing address and shipping address are different instances of the same local interface type, `Address`. `Address` is related to `PhoneNumber` in a one-to-many relationship. The example illustrates how a Bean Provider uses the set method to move a set of instances.

```
public void changePhoneNumber() {
    Address a = getShippingAddress();
    Address b = getBillingAddress();
    Collection c = b.getPhoneNumbers();
    a.setPhoneNumbers(b.getPhoneNumbers());
    if (c.isEmpty()) { // must be true...
        ...
    }
}
```

In the case of a many-to-many relationship, if the value of a cmr-field is assigned to a cmr-field of the same relationship type in another instance, the objects in the collection of the first instance are assigned as the contents of the cmr-field of the second instance. The identities of the collection objects referenced by the cmr-fields do not change. The contents of the collections are shared, but not the collections themselves. The set accessor method, when applied to a cmr-field in a many-to-many relationship thus has the semantics of the `java.util.Collection` methods `clear`, followed by `addAll`, applied to the target collection.

For example, if there is a many-to-many relationship between customers and sales representatives, assigning the set of customers of one sales representative to the another sales representative will result in both sales representatives handling the same customers. If the second sales representative originally handled a different group of customers, those customers will no longer be handled by that sales representative.

```
public void shareCustomers(SalesRep rep) {
    setCustomers(rep.getCustomers());
    // the customers are shared among the sales reps
}
```

The following section, 8.3.7, “Assignment Rules for Relationships”, defines the semantics of assignment for relationships in further detail.

8.3.7 Assignment Rules for Relationships

This section defines the semantics of assignment and collection manipulation in one-to-one, one-to-many, and many-to-many container-managed relationships.

The figures make use of two entity beans, with local interface types A and B. Instances with local interface type A are typically designated as a_1, \dots, a_n ; instances with local interface type B are typically designated as b_1, \dots, b_m . Interface A exposes accessor methods `getB` and `setB` for navigable relationships with B: `getB` returns an instance of B or a collection of instances of B, depending on the multiplicity of the relationship. Similarly, B exposes accessor methods `getA` and `setA` for navigable relationships with A.

All changes in each subsection are assumed to be applied to the figure labeled “Before change” at the beginning of the subsection (i.e., changes are not cumulative). The results of changes are designated graphically as well as in conditional expressions expressed in the JavaTM programming language.

8.3.7.1 One-to-one Bidirectional Relationships

A and B are in a one-to-one bidirectional relationship:

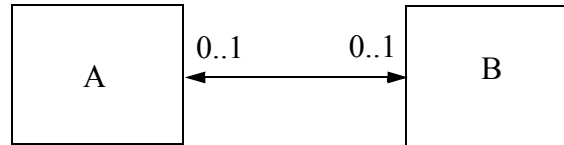

Before change:

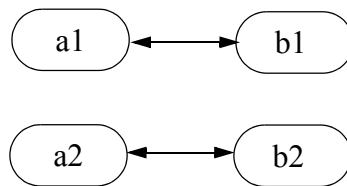

Before change:

```

B b1 = a1.getB();
B b2 = a2.getB();
  
```

Change:

```

a1.setB(a2.getB());
  
```

Expected result:

```

(b2.isIdentical(a1.getB())) &&
(a2.getB() == null) &&
(b1.getA() == null) &&
(a1.isIdentical(b2.getA()))
  
```

After change:

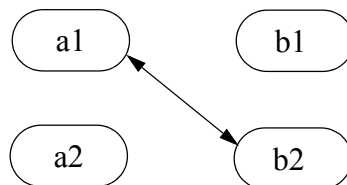

8.3.7.2 One-to-one Unidirectional Relationships

A and B are in a one-to-one unidirectional relationship:

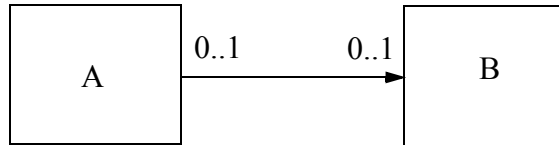

Before change:

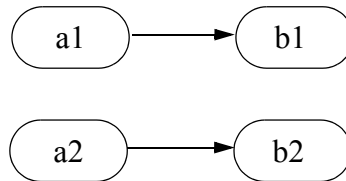

Before change:

```

B b1 = a1.getB();
B b2 = a2.getB();
  
```

Change:

```

a1.setB(a2.getB());
  
```

Expected result:

```

(b2.isIdentical(a1.getB())) && (a2.getB() == null)
  
```

After change:

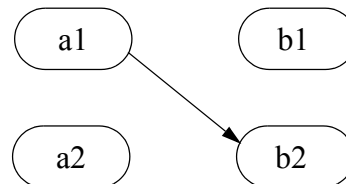

8.3.7.3 One-to-many Bidirectional Relationships

A and B are in a one-to-many bidirectional relationship:

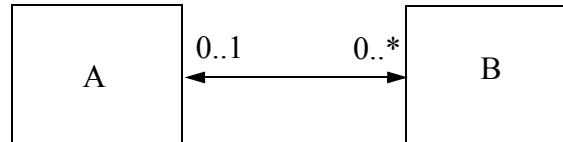

Before change:

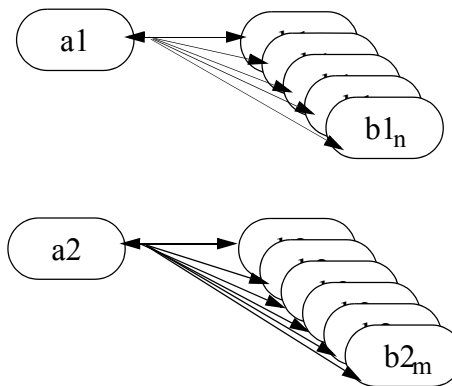

Before change:

```

Collection b1 = a1.getB();
Collection b2 = a2.getB();
B b11, b12, ... , b1n; // members of b1
B b21, b22, ... , b2m; // members of b2
  
```

Change:

```

a1.setB(a2.getB());
  
```

Expected result:

```
(a2.getB().isEmpty()) &&  
(b2.isEmpty()) &&  
(b1 == a1.getB()) &&  
(b2 == a2.getB()) &&  
(a1.getB().contains(b21)) &&  
(a1.getB().contains(b22)) && ... &&  
(a1.getB().contains(b2m)) &&  
(b11.getA() == null) &&  
(b12.getA() == null) && ... &&  
(b1n.getA() == null) &&  
(a1.isIdentical(b21.getA())) &&  
(a1.isIdentical(b22.getA())) && ...&&  
(a1.isIdentical(b2m.getA()))
```

After change:

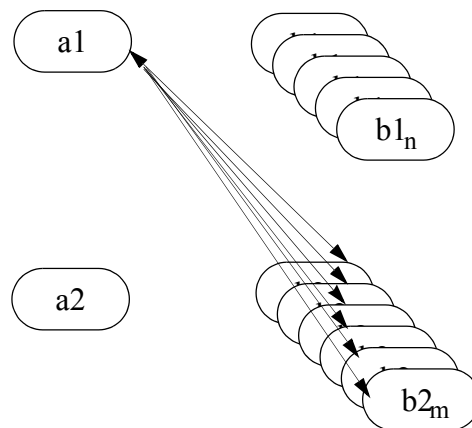

Change:

```
b2m.setA(b1n.getA());
```

Expected result:

```
(b1.contains(b11)) &&
(b1.contains(b12)) && ... &&
(b1.contains(b1n)) &&
(b1.contains(b2m)) &&
(b2.contains(b21)) &&
(b2.contains(b22)) && ... &&
(b2.contains(b2m_1)) &&
(a1.isIdentical(b11.getA())) &&
(a1.isIdentical(b12.getA())) && ... &&
(a1.isIdentical(b1n.getA())) &&
(a2.isIdentical(b21.getA())) &&
(a2.isIdentical(b22.getA())) && ... &&
(a2.isIdentical(b2m_1.getA())) &&
(a1.isIdentical(b2m.getA()))
```

After change:

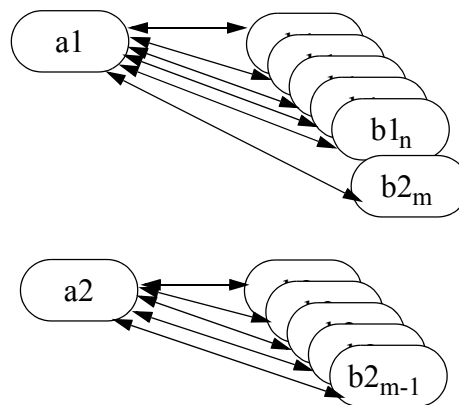

Change:

```
a1.getB().add(b2m);
```

Expected result:

```
(b1.contains(b11)) &&
(b1.contains(b12)) && ... &&
(b1.contains(b1n)) &&
(b1.contains(b2m)) &&
(b2.contains(b21)) &&
(b2.contains(b22)) && ... &&
(b2.contains(b2m_1)) &&
(a1.isIdentical(b11.getA())) &&
(a1.isIdentical(b12.getA())) && ... &&
(a1.isIdentical(b1n.getA())) &&
(a2.isIdentical(b21.getA())) &&
(a2.isIdentical(b22.getA())) && ... &&
(a2.isIdentical(b2m_1.getA())) &&
(a1.isIdentical(b2m.getA()))
```

After change:

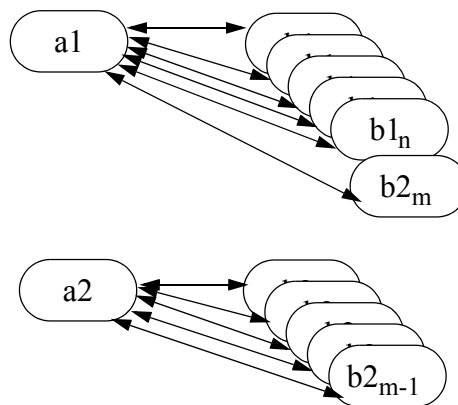

Change:

```
a1.getB().remove(b1n);
```

Expected result:

```
(b1n.getA() == null) &&
(b1 == a1.getB()) &&
(b1.contains(b11)) &&
(b1.contains(b12)) && ... &&
(b1.contains(b1n_1)) &&
!(b1.contains(b1n))
```

After change:

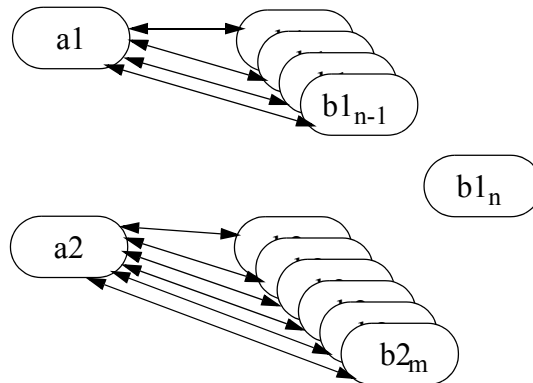

8.3.7.4 One-to-many Unidirectional Relationships

A and B are in a one-to-many unidirectional relationship:

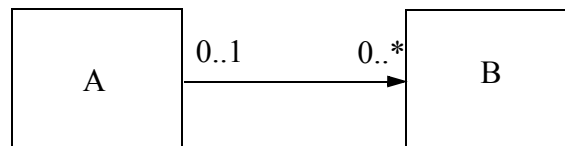

Before change:

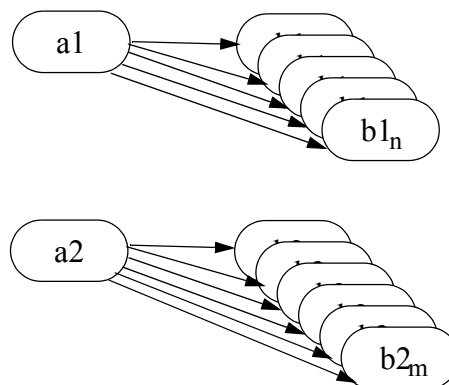

Before change:

```
Collection b1 = a1.getB();
Collection b2 = a2.getB();
B b11, b12, ... , b1n; // members of b1
B b21, b22, ... , b2m; // members of b2
```

Change:

```
a1.setB(a2.getB());
```

Expected result:

```
(a2.getB().isEmpty()) &&
(b2.isEmpty()) &&
(b1 == a1.getB()) &&
(b2 == a2.getB()) &&
(a1.getB().contains(b21)) &&
(a1.getB().contains(b22)) && ... &&
(a1.getB().contains(b2m))
```

After change:

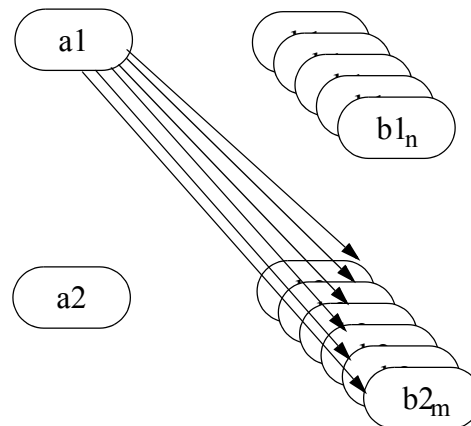

Change:

```
a1.getB().add(b2m);
```

Expected result:

```
(b1 == a1.getB()) &&
(b1.contains(b2m))
```

After change:

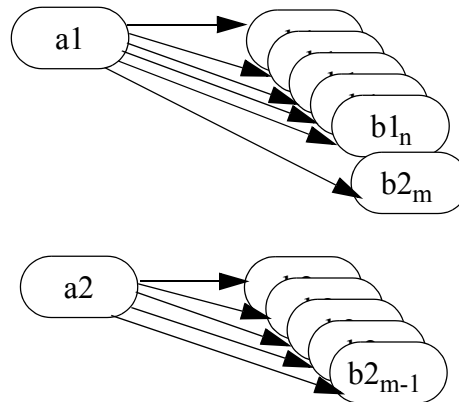

Change:

```
a1.getB().remove(b1n);
```

Expected result:

```
(a1.getB().contains(b11)) &&
(a1.getB().contains(b12)) && ... &&
(a1.getB().contains(b1n_1)) &&
!(a1.getB().contains(b1n)) &&
```

After change:

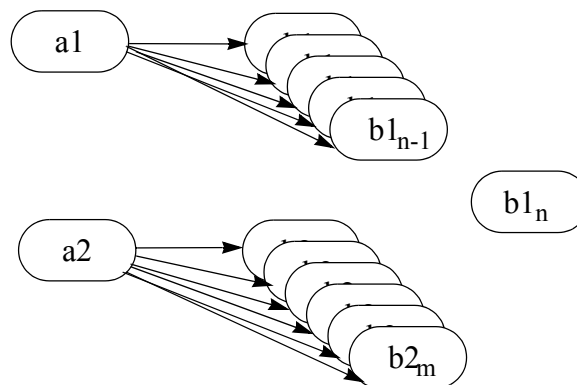

8.3.7.5 Many-to-one Unidirectional Relationships

A and B are in a many-to-one unidirectional relationship:

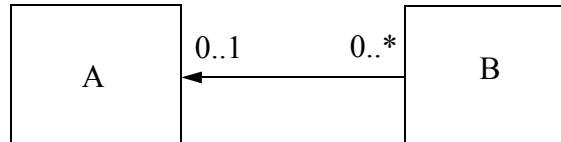

Before change:

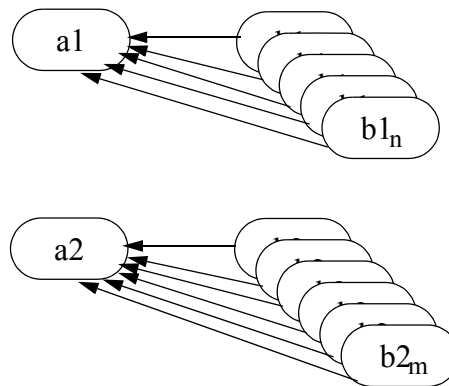

Before change:

```

B b11, b12, ... , b1n;
B b21, b22, ... , b2m;
// the following is true
// (a1.isIdentical(b11.getA())) && ... && (a1.isIdentical(b1n.getA()
)) &&
// (a2.isIdentical(b21.getA())) && ... && (a2.isIdentical(b2m.getA()
))
  
```

Change:

```

b1j.setA(b2k.getA());
  
```

Expected result:

```
(a1.isIdentical(b11.getA())) &&  
(a1.isIdentical(b12.getA())) &&  
...  
(a2.isIdentical(b1j.getA())) &&  
...  
(a1.isIdentical(b1n.getA())) &&  
(a2.isIdentical(b21.getA())) &&  
(a2.isIdentical(b22.getA())) &&  
...  
(a2.isIdentical(b2k.getA())) &&  
...  
(a2.isIdentical(b2m.getA()))
```

After change:

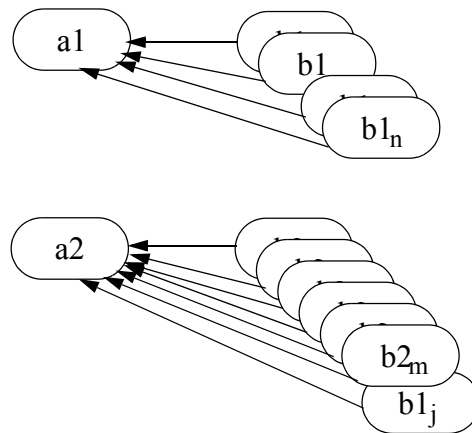

8.3.7.6 Many-to-many Bidirectional Relationships

A and B are in a many-to-many bidirectional relationship:

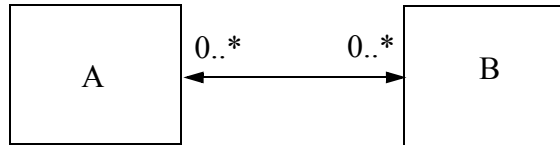

Before change:

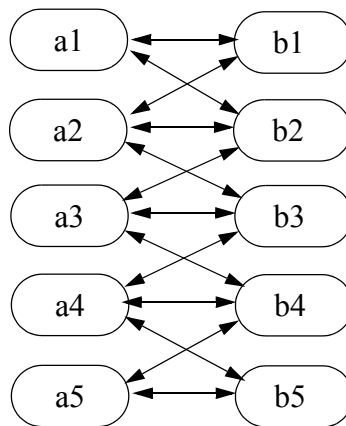

Before change the following holds:

```
(a1.getB().contains(b1)) &&
(a1.getB().contains(b2)) &&
(a2.getB().contains(b1)) &&
(a2.getB().contains(b2)) &&
(a2.getB().contains(b3)) &&
(a3.getB().contains(b2)) &&
(a3.getB().contains(b3)) &&
(a3.getB().contains(b4)) &&
(a4.getB().contains(b3)) &&
(a4.getB().contains(b4)) &&
(a4.getB().contains(b5)) &&
(a5.getB().contains(b4)) &&
(a5.getB().contains(b5)) &&
(b1.getA().contains(a1)) &&
(b1.getA().contains(a2)) &&
(b2.getA().contains(a1)) &&
(b2.getA().contains(a2)) &&
(b2.getA().contains(a3)) &&
(b3.getA().contains(a2)) &&
(b3.getA().contains(a3)) &&
(b3.getA().contains(a4)) &&
(b4.getA().contains(a3)) &&
(b4.getA().contains(a4)) &&
(b4.getA().contains(a5)) &&
(b5.getA().contains(a4)) &&
(b5.getA().contains(a5)) &&
```

Change:

```
a1.setB(a3.getB());
```

Expected result:

```
(a1.getB().contains(b2)) &&
(a1.getB().contains(b3)) &&
(a1.getB().contains(b4)) &&
(a3.getB().contains(b2)) &&
(a3.getB().contains(b3)) &&
(a3.getB().contains(b4)) &&
(b1.getA().contains(a2)) &&
(b2.getA().contains(a1)) &&
(b2.getA().contains(a2)) &&
(b2.getA().contains(a3)) &&
(b3.getA().contains(a1)) &&
(b3.getA().contains(a2)) &&
(b3.getA().contains(a3)) &&
(b3.getA().contains(a4)) &&
(b4.getA().contains(a1)) &&
(b4.getA().contains(a3)) &&
(b4.getA().contains(a4)) &&
(b4.getA().contains(a5))
```

After change:

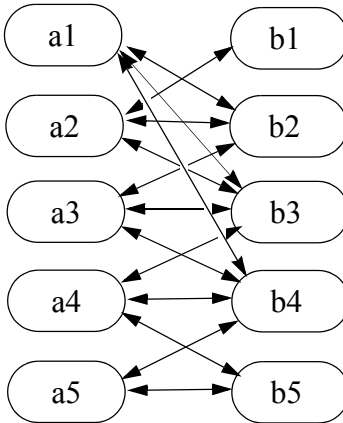

Change:

```
a1.getB().add(b3);
```

Expected result:

```
(a1.getB().contains(b1)) &&  
(a1.getB().contains(b2)) &&  
(a1.getB().contains(b3)) &&  
(b3.getA().contains(a1)) &&  
(b3.getA().contains(a2)) &&  
(b3.getA().contains(a3)) &&  
(b3.getA().contains(a4)) &&
```

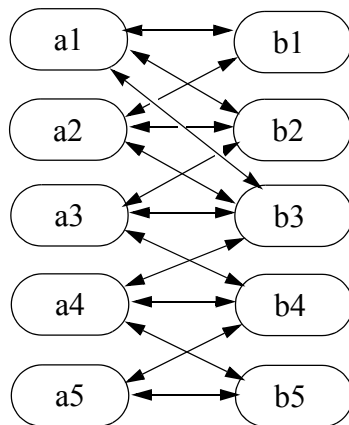
After change:

Change:

```
a2.getB().remove(b2);
```

Expected result:

```
(a2.getB().contains(b1)) &&
(a2.getB().contains(b3)) &&
(b2.getA().contains(a1)) &&
(b2.getA().contains(a3))
```

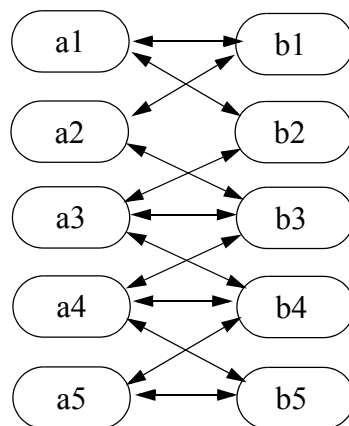
After change:

8.3.7.7 Many-to-many Unidirectional Relationships

A and B are in a many-to-many unidirectional relationship:

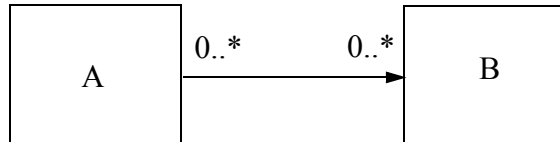

Before change:

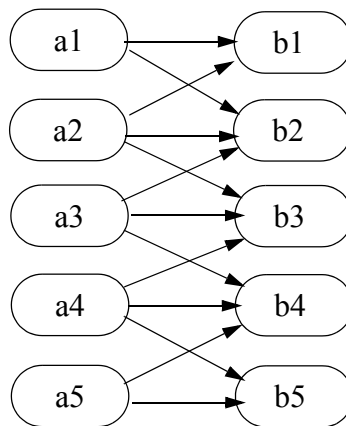

Before change the following holds:

```

(a1.getB().contains(b1)) &&
(a1.getB().contains(b2)) &&
(a2.getB().contains(b1)) &&
(a2.getB().contains(b2)) &&
(a2.getB().contains(b3)) &&
(a3.getB().contains(b2)) &&
(a3.getB().contains(b3)) &&
(a3.getB().contains(b4)) &&
(a4.getB().contains(b3)) &&
(a4.getB().contains(b4)) &&
(a4.getB().contains(b5)) &&
(a5.getB().contains(b4)) &&
(a5.getB().contains(b5)) &&
  
```

Change:

```

a1.setB(a3.getB());
  
```

Expected Result:

```
(a1.getB().contains(b2)) &&  
(a1.getB().contains(b3)) &&  
(a1.getB().contains(b4)) &&  
(a3.getB().contains(b2)) &&  
(a3.getB().contains(b3)) &&  
(a3.getB().contains(b4)) &&
```

After change:

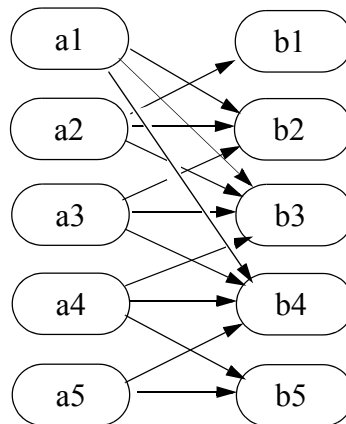

Change:

```
a1.getB().add(b3);
```

Expected result:

```
(a1.getB().contains(b1)) &&  
(a1.getB().contains(b2)) &&  
(a1.getB().contains(b3))
```

After change:

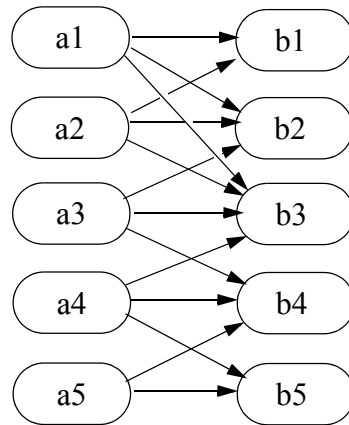

Change:

```
a2.getB().remove(b2);
```

Expected result:

```
(a2.getB().contains(b1)) &&  
(a2.getB().contains(b3))
```

After change:

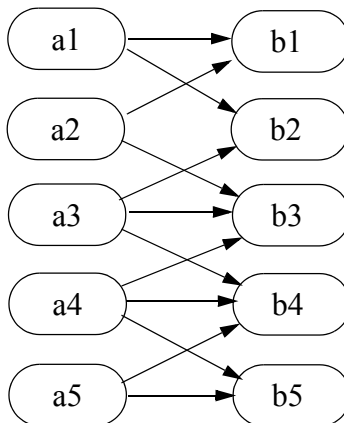

8.3.8 Collections Managed by the Container

The collections that are used in the representation of one-to-many and many-to-many container-managed relationships are implemented and managed by the container. The following semantics apply to these collections:

- It is the responsibility of the container to preserve the runtime identity of the collection objects used in container-managed relationships.
- There is no constructor available to the Bean Provider for the container-managed collections.
- If there are no related values for a given container-managed relationship, the `get` accessor method for that `cmr-field` returns an empty collection (and not `null`).
- It is the responsibility of the container to raise the `java.lang.IllegalArgumentException` if the Bean Provider attempts to assign `null` as the value of a collection-valued `cmr-field` by means of the `set` accessor method.
- It is the responsibility of the container to ensure that when the `java.util.Collection` API is used to manipulate the contents of container-managed relationship fields, the argument to any `Collection` method defined with a single `Object` parameter must be of the element type of the collection defined for the target `cmr-field`. The argument for any collection-valued parameter must be a `java.util.Collection` (or `java.util.Set`), all of whose elements are of the element type of the collection defined for the target `cmr-field`. If an argument is not of the correct type for the relationship, the container must throw the `java.lang.IllegalArgumentException`.
- It is the responsibility of the container to throw the `java.lang.IllegalStateException` if an attempt is made to modify a container-managed collection corresponding to a multivalued `cmr-field` using the `java.util.Collection` API outside of the transaction context in which the collection object was initially materialized.
- It is the responsibility of the container to throw the `java.lang.IllegalStateException` if an attempt is made to use a `java.util.Iterator` for a container-managed collection in a transaction context other than that in which the iterator was obtained.

8.3.9 Non-persistent State

The Bean Provider may use instance variables in the entity bean instance to maintain non-persistent state, e.g. a JMS connection.

The Bean Provider can use instance variables to store values that depend on the persistent state of the entity bean instance, although this use is not encouraged. The Bean Provider should use the `ejbLoad` method to resynchronize the values of any instance variables that depend on the entity bean's persistent state. In general, any non-persistent state that depends on the persistent state of an entity bean should be recomputed during the `ejbLoad` method.

The Bean Provider should exercise care in passing the contents of instance variables as the arguments or results of method invocations when local interfaces are used. In general, the Bean Provider should avoid passing state that is maintained in instance variables as the argument or result of a local method invocation.

8.3.10 The Relationship Between the Internal View and the Client View

In designing the entity bean, the Bean Provider should keep in mind the following:

- The classes that are exposed by the remote interface are decoupled from the persistence layer. Instances of these classes are passed to and from the client by value.
- The classes that are exposed by the local interface of the bean may be tightly coupled to the bean's internal state. Instances of these classes are passed to and from the client by reference and may therefore be modified by the client. The Bean Provider should exercise care in determining what is exposed through the local interface of the bean.

8.3.10.1 Restrictions on Remote Interfaces

The following restrictions apply to the remote interface of an entity bean with container-managed persistence.

- The Bean Provider must not expose the get and set methods for container-managed relationship fields or the persistent `Collection` classes that are used in container-managed relationships through the remote interface of the bean.
- The Bean Provider must not expose local interface types or local home interface types through the remote interface or remote home interface of the bean.
- The Bean Provider must not expose the container-managed collection classes that are used for relationships through the remote interface of the bean.
- The Bean Provider must not expose timers or timer handles through the remote interface of the bean.

Dependent value classes can be exposed in the remote interface or remote home interface and can be included in the client `ejb-jar` file.

The Bean Provider is free to expose get and set methods that correspond to `cmp`-fields of the entity bean through the bean's remote interface.

8.3.11 Mapping Data to a Persistent Store

This specification does not prescribe how the abstract persistence schema of an entity bean should be mapped to a relational (or other) schema of a persistent store, or define how such a mapping is described.

8.3.12 Example

Figure 13 illustrates an `Order` entity bean with relationships to line items and customers, which are other entity beans within the same local scope. `Product` is indirectly related to `Order` by means of the relationship between `LineItem` and `Product`. Sample code for the `OrderBean` class follows the figure.

Figure 13 Relationship Example

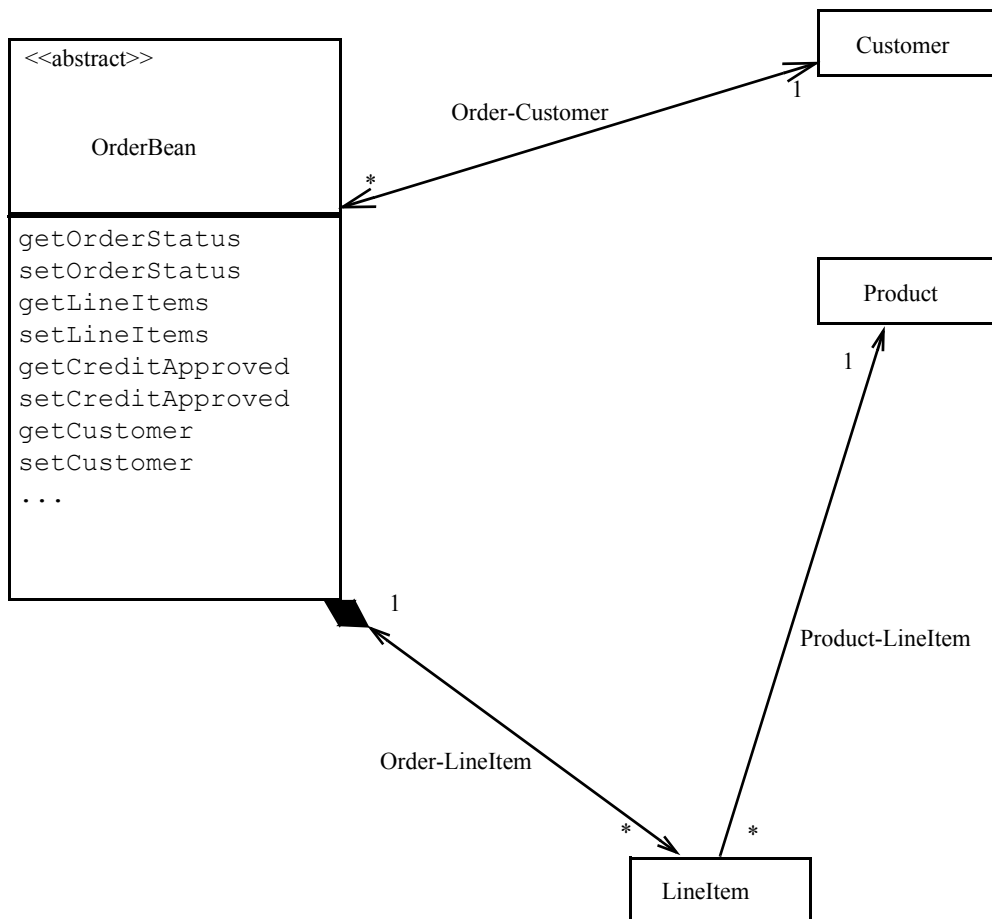

```
package com.acme.order;

// This example shows the implementation of OrderBean, the
// entity bean class for the OrderEJB entity bean. OrderEJB has
// container-managed relationships with the entity beans
// CustomerEJB and LineItemEJB.
// This example illustrates the use of local interfaces.

import java.util.Collection;
import java.util.Vector;
import java.util.Date;

import javax.naming.*;

public abstract class OrderBean implements javax.ejb.EntityBean {

    private javax.ejb.EntityContext context;

    // define status codes for processing

    static final int BACKORDER = 1;
    static final int SHIPPED = 2;
    static final int UNSHIPPED = 3;

    // get and set methods for the cmp fields

    public abstract int getOrderStatus();
    public abstract void setOrderStatus(int orderStatus);

    public abstract boolean getCreditApproved();
    public abstract void setCreditApproved(boolean creditapproved);

    public abstract Date getOrderDate();
    public abstract void setOrderDate(Date orderDate);

    // get and set methods for the relationship fields

    public abstract Collection getLineItems();
    public abstract void setLineItems(Collection lineitems);

    public abstract Customer getCustomer();
    public abstract void setCustomer(Customer customer);

    // business methods.

    // addLineItem:
    // This method is used to add a line item.
    // It creates the lineitem object and adds it to the
    // persistent managed relationship.

    public void addLineItem(Product product,
                            int quantity,
                            Address address)
        throws InsufficientInfoException
    {
        // create a new line item
    }
}
```

```

if (validAddress(address)) {
    // Address is a legacy class. It is a dependent value
    // class that is available both in the client and in
    // the entity bean, and is serializable.
    // We will use the address as the value of a cmp field
    // of lineItem.

    try {
        Context ic = new InitialContext();
        LineItemLocalHome litemLocalHome =
            (LineItemLocalHome)ic.lookup("LineItemEJB");
        LineItem litem = litemLocalHome.create();

        litem.setProduct(product);
        litem.setQuantity(quantity);
        litem.setTax(calculateTax(product.getPrice(),
                                quantity,
                                address));
        litem.setStatus(UNSHIPPED);
        // set the address for the line item to be shipped
        litem.setAddress(address);
        // The lineItem entity bean uses a dependent value
        // class to represent the dates for the order status.
        // This class holds shipment date, expected shipment
        // date, credit approval date, and inventory
        // dates which are internal to the order fulfillment
        // process. Not all this information will be available
        // to the client.

        Dates dates = new Dates();
        litem.setDates(dates);
        getLineItems().add(litem);
    } catch (Exception someexception) {}
} else {
    throw new InsufficientInfoException();
}

// getOrderLineItems:
// This method makes a view of the lineitems that are in this
// order available in the client. It makes only the relevant
// information visible to the client and hides the internal
// details of the representation of the lineitem
public Collection getOrderLineItems() {
    Vector clientlineitems = new Vector();
    Collection lineitems = getLineItems();
    java.util.Iterator iterator = lineitems.iterator();
    // ClientLineItem is a value class that is used in
    // the client view.
    // The entity bean provider abstracts from the persistent
    // representation of the line item to construct the client
    // view.
    ClientLineItem clitem;
    while (iterator.hasNext()) {
        LineItem litem = (LineItem)iterator.next();
        clitem = new ClientLineItem();
        // only the name of the product is available in the
        // client view
    }
}

```

```

        clitem.setProductName(litem.getProduct().getName());
        clitem.setQuantity(litem.getQuantity());
        // the client view gets a specific descriptive message
        // depending on the line item status.
        clitem.setCurrentStatus(
            statusCodeToString(litem.getStatus()));
        // address is not copied to the client view.
        // as this class includes other information with
        // respect to the order handing that should not be
        // available to the client. Only the relevant info
        // is copied.
        int lineitemStatus = litem.getStatus();
        if ( lineitemStatus == BACKORDER) {
            clitem.setShipDate(
                litem.getDates().getExpectedShipDate());
        } else if (lineitemStatus == SHIPPED) {
            clitem.setShipDate(
                litem.getDates().getShippedDate());
        }
        //add the new line item
        clientlineitems.add(clitem);
    }
    // return the value objects to the client
    return clientlineitems;
}

// other methods internal to the entity bean class
...

// other javax.ejb.EntityBean methods
...
}

```

8.3.13 The Bean Provider's View of the Deployment Descriptor

The persistent fields (cmp-fields) and relationships (cmr-fields) of an entity bean must be declared in the deployment descriptor.

The deployment descriptor provides the following information about the abstract persistence schemas of entity beans and their container-managed relationships:

- An `ejb-name` element for each entity bean. The `ejb-name` must be a valid Java identifier and must be unique within the `ejb-name` elements of the `ejb-jar` file.
- An `abstract-schema-name` element for each entity bean. The `abstract-schema-name` must be a valid Java identifier and must be unique within the `abstract-schema-name` elements of the `ejb-jar` file. The `abstract-schema-name` element is used in the specification of EJB QL queries.
- A set of `ejb-relation` elements, each of which contains a pair of `ejb-relation-ship-role` elements to describe the two roles in the relationship.^[33]

- Each `ejb-relationship-role` element describes a relationship role: its name, its multiplicity within a relation, and its navigability. It specifies the name of the `cmr-field` that is used from the perspective of the relationship participant. The `cmr-field-type` element must be specified if the type of the `cmr-field` is `java.util.Collection` or `java.util.Set`. Each relationship role refers to an entity bean by means of an `ejb-name` element contained in the `relationship-role-source` element.

[33] The relation names and the relationship role names are not used in the code provided by the Bean Provider.

The following example shows a deployment descriptor segment that defines the abstract persistence schema for a set of related entity beans. The deployment descriptor elements for container-managed persistence and relationships are described further in Chapter 19.

```

<ejb-jar>
...
<enterprise-beans>
...
</enterprise-beans>

<relationships>

<!--
ONE-TO-MANY: Order LineItem
-->

    <ejb-relation>
      <ejb-relation-name>Order-LineItem</ejb-relation-name>
      <ejb-relationship-role>
        <ejb-relationship-role-name>
          order-has-lineitems
        </ejb-relationship-role-name>
        <multiplicity>One</multiplicity>
        <relationship-role-source>
          <ejb-name>OrderEJB</ejb-name>
        </relationship-role-source>
        <cmr-field>
          <cmr-field-name>lineItems</cmr-field-name>
          <cmr-field-type>java.util.Collection
          </cmr-field-type>
        </cmr-field>
      </ejb-relationship-role>

      <ejb-relationship-role>
        <ejb-relationship-role-name>lineitem-belongsto-order
        </ejb-relationship-role-name>
        <multiplicity>Many</multiplicity>
        <cascade-delete/>
        <relationship-role-source>
          <ejb-name>LineItemEJB</ejb-name>
        </relationship-role-source>
        <cmr-field>
          <cmr-field-name>order</cmr-field-name>
        </cmr-field>
      </ejb-relationship-role>
    </ejb-relation>

<!--
ONE-TO-MANY unidirectional relationship:
Product is not aware of its relationship with LineItem
-->

    <ejb-relation>
      <ejb-relation-name>Product-LineItem</ejb-relation-name>

      <ejb-relationship-role>
        <ejb-relationship-role-name>

```

```

        product-has-lineitems
    </ejb-relationship-role-name>
    <multiplicity>One</multiplicity>
    <relationship-role-source>
        <ejb-name>ProductEJB</ejb-name>
    </relationship-role-source>
    <!-- since Product does not know about LineItem
        there is no cmr field in Product for accessing
        Lineitem
        -->
</ejb-relationship-role>

<ejb-relationship-role>
    <ejb-relationship-role-name>
        lineitem-for-product
    </ejb-relationship-role-name>
    <multiplicity>Many</multiplicity>
    <relationship-role-source>
        <ejb-name>LineItemEJB</ejb-name>
    </relationship-role-source>
    <cmr-field>
        <cmr-field-name>product</cmr-field-name>
    </cmr-field>
</ejb-relationship-role>
</ejb-relation>

<!--
ONE-TO-MANY: Order Customer:
-->

<ejb-relation>
    <ejb-relation-name>Order-Customer</ejb-relation-name>

    <ejb-relationship-role>
        <ejb-relationship-role-name>
            customer-has-orders
        </ejb-relationship-role-name>
        <multiplicity>One</multiplicity>
        <relationship-role-source>
            <ejb-name>CustomerEJB</ejb-name>
        </relationship-role-source>
        <cmr-field>
            <cmr-field-name>orders</cmr-field-name>
            <cmr-field-type>java.util.Collection
        </cmr-field-type>
        </cmr-field>
    </ejb-relationship-role>

    <ejb-relationship-role>
        <ejb-relationship-role-name>
            order-belongsto-customer
        </ejb-relationship-role-name>
        <multiplicity>Many</multiplicity>
        <relationship-role-source>
            <ejb-name>OrderEJB</ejb-name>
        </relationship-role-source>
        <cmr-field>

```

```
        <cmr-field-name>customer</cmr-field-name>
      </cmr-field>
    </ejb-relationship-role>
  </ejb-relation>

</relationships>
...
</ejb-jar>
```

8.4 The Entity Bean Component Contract

This section specifies the container-managed persistence contract between an entity bean and its container.

8.4.1 Runtime Execution Model of Entity Beans

This subsection describes the runtime model and the classes used in the description of the contract between an entity bean and its container. Figure 14 shows an overview of the runtime model. The client of an entity bean may be a local client or it may be a remote client.

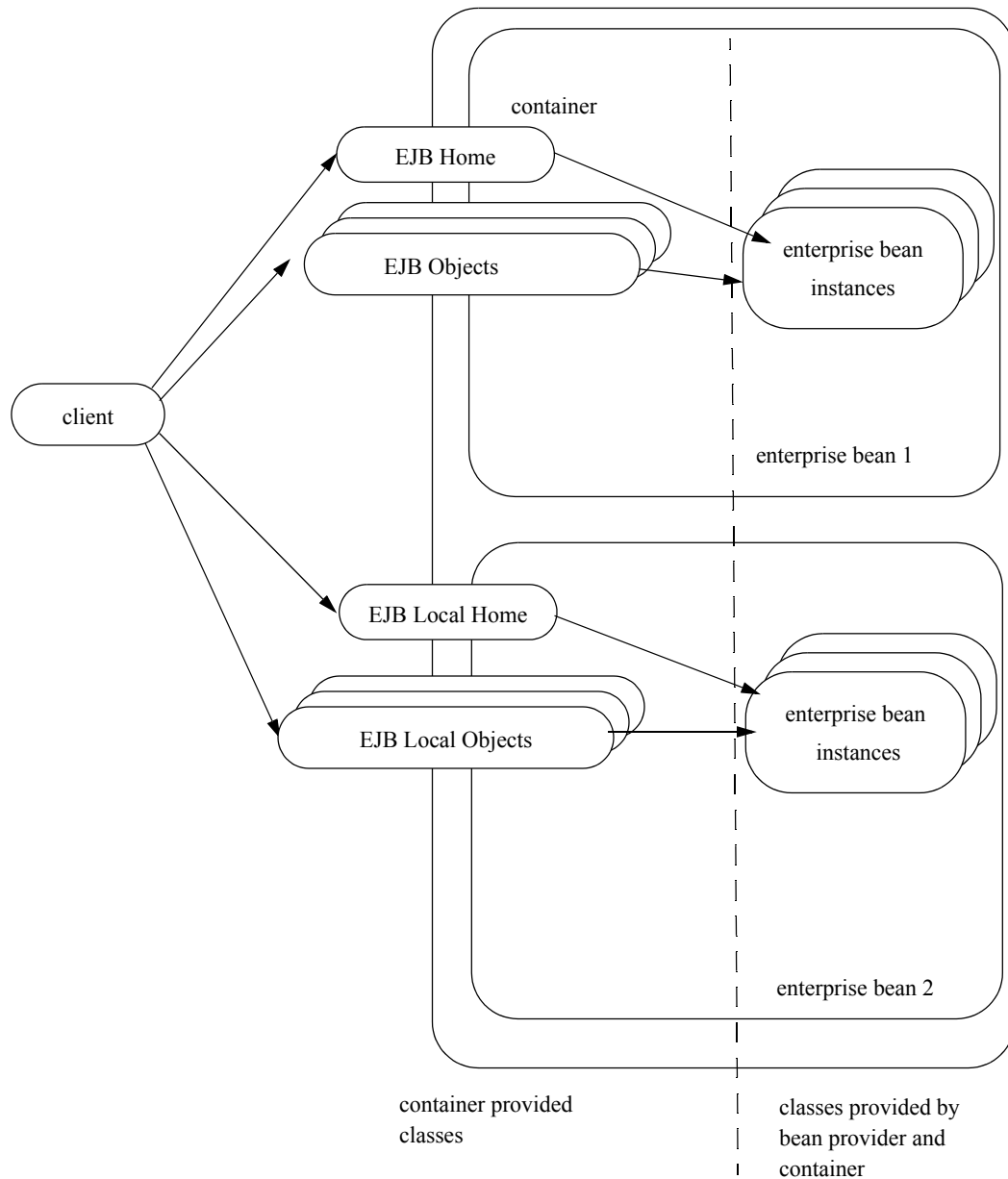
Figure 14 Overview of the Entity Bean Runtime Execution Model

An enterprise bean is an object whose class is provided by the Bean Provider. The class of an entity bean with container-managed persistence is abstract. The concrete bean class is generated by the Container Provider's tools at deployment time. The container is also responsible for providing the implementation of the `java.util.Collection` classes that are used in maintaining the container-managed relationships of the entity bean.

An entity **EJBObject** or **EJBLocalObject** is an object whose class was generated at deployment time by the Container Provider's tools. A client never references an entity bean instance directly—a client always references an entity **EJBObject** or **EJBLocalObject** whose class is generated by the Container Provider's tools. The entity **EJBObject** class implements an entity bean's remote interface. The entity **EJBLocalObject** class implements an entity bean's local interface. A related entity bean never references another entity bean instance directly—a related entity bean, like any other local client of an entity bean, always references an entity **EJBLocalObject** whose class is generated by the Container Provider's tools.

An entity **EJBHome** or **EJBLocalHome** object provides life cycle operations (create, find, remove) for its entity objects as well as home business methods, which are business methods that are not specific to an entity bean instance. The class for the entity **EJBHome** or **EJBLocalHome** object is generated by the Container Provider's tools at deployment time. The entity **EJBHome** or **EJBLocalHome** object implements the entity bean's remote or local home interface that was defined by the Bean Provider.

8.4.2 Container Responsibilities

The following are the container responsibilities for the management of persistent state.

8.4.2.1 Container-Managed Fields

An entity bean with container-managed persistence relies on the container to perform persistent data access on behalf of the entity bean instances. The container transfers data between an entity bean instance and the underlying resource manager. The container also implements the creation, removal, and lookup of the entity object in the underlying database.

The container transfers data between the entity bean and the underlying data source as a result of the execution of the entity bean's methods. Because of the requirement that all data access occur through the accessor methods, the container can implement both eager and lazy loading and storing schemes.

The container is responsible for implementing the entity bean class by providing the implementation of the get and set accessor methods for its abstract persistence schema. The container is allowed to use Java serialization to store the container-managed persistent fields (cmp-fields).

The container must also manage the mapping between primary keys and **EJBLocalObjects** or **EJBObjects**. If both a remote and a local interface are specified for the entity bean, the container must manage the mapping between **EJBObjects** and **EJBLocalObjects**.

Because the container is free to optimize the delivery of persistent data to the bean instance (for example, by the use of lazy loading strategies), the contents of the entity bean instance and the contents of container-managed collections may not be fully materialized.

8.4.2.2 Container-Managed Relationships

The container maintains the relationships among entity beans.

- It is the responsibility of the container to maintain the referential integrity of the container-managed relationships, as described in Section 8.3.6, in accordance with the semantics of the relationship type as specified in the deployment descriptor. For example, if an entity

bean is added to a collection corresponding to the container-managed relationship field of another entity bean, the container-managed relationship field of the first entity bean must also be updated by the container in the same transaction context.

- It is the responsibility of the container to throw the `java.lang.IllegalArgumentException` when the argument to a set method in a relationship is an instance of the wrong relationship type or a collection containing instances of the wrong type, or when an argument to a method of the `java.util.Collection` API used to manipulate a collection-valued container-managed relationship field is an instance of the wrong type or a collection that contains instances of the wrong type (see Section 8.3.6).
- It is the responsibility of the container to throw the `java.lang.IllegalStateException` when a method of the `java.util.Collection` API is used to access a collection-valued cmr-field within a transaction context other than the transaction context in which the cmr-field was initially materialized. For example, if the container-managed collection is returned as the result of a local interface method with transaction attribute `RequiresNew`, and the client attempts to access the collection, the container must throw the `IllegalStateException`.
- It is the responsibility of the container to throw the `java.lang.IllegalStateException` when a `java.util.Iterator` is used to access a collection-valued cmr-field within a transaction context other than the transaction context in which the iterator was initially obtained.

8.5 Instance Life Cycle Contract Between the Bean and the Container

This section describes the part of the component contract between the entity bean and the container that relates to the management of the entity bean instance's life cycle.

8.5.1 Instance Life Cycle

Figure 15 Life Cycle of an Entity Bean Instance.

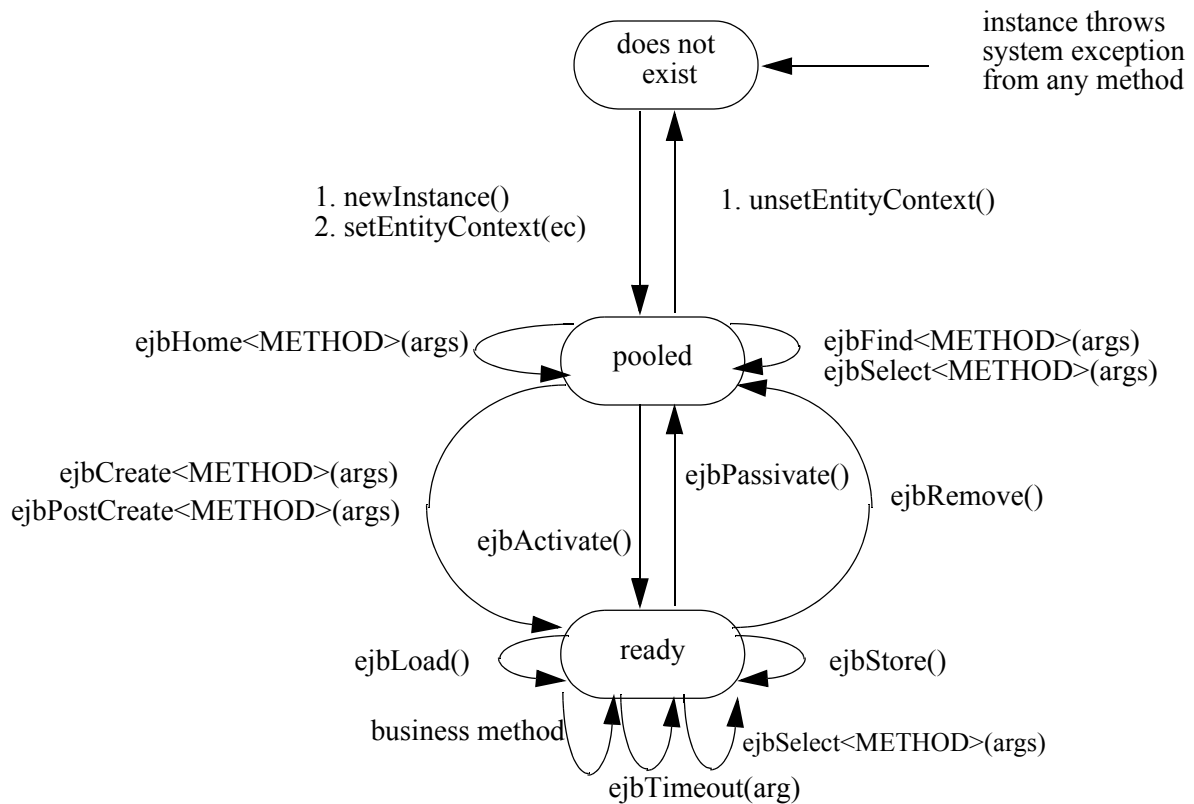

An entity bean instance is in one of the following three states:

- It does not exist.
- Pooled state. An instance in the pooled state is not associated with any particular entity object identity.
- Ready state. An instance in the ready state is assigned an entity object identity.

The following steps describe the life cycle of an entity bean instance:

- An entity bean instance's life starts when the container creates the instance using `newInstance`. The container then invokes the `setEntityContext` method to pass the instance a reference to the `EntityContext` interface. The `EntityContext` interface allows the

instance to invoke services provided by the container and to obtain the information about the caller of a client-invoked method.

- The instance enters the pool of available instances. Each entity bean has its own pool. While the instance is in the available pool, the instance is not associated with any particular entity object identity. All instances in the pool are considered equivalent, and therefore any instance can be assigned by the container to any entity object identity at the transition to the ready state. While the instance is in the pooled state, the container may use the instance to execute any of the entity bean's finder methods (shown as `ejbFind<METHOD>` in the diagram) or any of the entity bean's home methods (shown `ejbHome<METHOD>` in the diagram). The instance does *not* move to the ready state during the execution of a finder or a home method. An `ejbSelect<METHOD>` method may be called by an entity bean's home method while the instance is in the pooled state.
- An instance transitions from the pooled state to the ready state when the container selects that instance to service a client call to an entity object or an `ejbTimeout` method. There are two possible transitions from the pooled to the ready state: through the `ejbCreate<METHOD>` and `ejbPostCreate<METHOD>` methods, or through the `ejbActivate` method. The container invokes the `ejbCreate<METHOD>` and `ejbPostCreate<METHOD>` methods when the instance is assigned to an entity object during entity object creation (i.e., when the client invokes a create method on the entity bean's home object). The container invokes the `ejbActivate` method on an instance when an instance needs to be activated to service an invocation on an existing entity object—this occurs because there is no suitable instance in the ready state to service the client's call or the `ejbTimeout` method.
- When an entity bean instance is in the ready state, the instance is associated with a specific entity object identity. While the instance is in the ready state, the container can synchronize the state of the instance with the state of the entity in the underlying data source whenever it determines the need to, in the process invoking the `ejbLoad` and `ejbStore` methods zero or more times. A business method can be invoked on the instance zero or more times. The `ejbTimeout` method can be invoked on the instance zero or more times. Invocations of the `ejbLoad` and `ejbStore` methods can be arbitrarily mixed with invocations of business methods and `ejbTimeout` method invocations. An `ejbSelect<METHOD>` method can be called by a business method (or `ejbLoad` or `ejbStore` method or `ejbTimeout` method) while the instance is in the ready state.
- The container can choose to passivate an entity bean instance within a transaction. To passivate an instance, the container first invokes the `ejbStore` method to allow the instance to prepare itself for the synchronization of the database state with the instance's state, and then the container invokes the `ejbPassivate` method to return the instance to the pooled state.
- Eventually, the container will transition the instance to the pooled state. There are three possible transitions from the ready to the pooled state: through the `ejbPassivate` method, through the `ejbRemove` method, and because of a transaction rollback for `ejbCreate`, `ejbPostCreate`, or `ejbRemove` (not shown in Figure 15). The container invokes the `ejbPassivate` method when the container wants to disassociate the instance from the entity object identity without removing the entity object. The container invokes the `ejbRemove` method when the container is removing the entity object (i.e., when the client invoked the `remove` method on the entity object's component interface or a `remove` method on the

entity bean's home interface). If `ejbCreate`, `ejbPostCreate`, or `ejbRemove` is called and the transaction rolls back, the container will transition the bean instance to the pooled state.

- When the instance is put back into the pool, it is no longer associated with an entity object identity. The container can assign the instance to any entity object within the same entity bean home.
- The container can remove an instance in the pool by calling the `unsetEntityContext` method on the instance.

Notes:

1. The `EntityContext` interface passed by the container to the instance in the `setEntityContext` method is an interface, not a class that contains static information. For example, the result of the `EntityContext.getPrimaryKey` method might be different each time an instance moves from the pooled state to the ready state, and the result of the `getCallerPrincipal` and `isCallerInRole` methods may be different in each business method.
2. A `RuntimeException` thrown from any method of an entity bean class (including the business methods and the callbacks invoked by the container) results in the transition to the "does not exist" state. The container must not invoke any method on the instance after a `RuntimeException` has been caught. From the caller's perspective, the corresponding entity object continues to exist. The client can continue accessing the entity object through its component interface because the container can use a different entity bean instance to delegate the client's requests. Exception handling is described further in Chapter 14.
3. The container is not required to maintain a pool of instances in the pooled state. The pooling approach is an example of a possible implementation, but it is not the required implementation. Whether the container uses a pool or not has no bearing on the entity bean coding style.

8.5.2 Bean Provider's Entity Bean Instance's View

The following describes the entity bean instance's view of the contract as seen by the Bean Provider:

The entity Bean Provider is responsible for implementing the following methods in the abstract entity bean class:

- A public constructor that takes no arguments.
- `public void setEntityContext(EntityContext ic);`

A container uses this method to pass a reference to the `EntityContext` interface to the entity bean instance. If the entity bean instance needs to use the `EntityContext` interface during its lifetime, it must remember the `EntityContext` interface in an instance variable.

This method executes with an unspecified transaction context (Refer to Subsection 13.6.5 for how the container executes methods with an unspecified transaction context). An identity of an entity object is not available during this method. The entity bean must not attempt to access its persistent state and relationships using the accessor methods during this method.

The instance can take advantage of the `setEntityContext()` method to allocate any resources that are to be held by the instance for its lifetime. Such resources cannot be specific to an entity object identity because the instance might be reused during its lifetime to serve multiple entity object identities.

- `public void unsetEntityContext();`

A container invokes this method before terminating the life of the instance.

This method executes with an unspecified transaction context. An identity of an entity object is not available during this method. The entity bean must not attempt to access its persistent state and relationships using the accessor methods during this method.

The instance can take advantage of the `unsetEntityContext` method to free any resources that are held by the instance. (These resources typically had been allocated by the `setEntityContext` method.)

- `public PrimaryKeyClass ejbCreate<METHOD>(...);`

There are zero^[34] or more `ejbCreate<METHOD>` methods, whose signatures match the signatures of the `create<METHOD>` methods of the entity bean's home interface. The container invokes an `ejbCreate<METHOD>` method on an entity bean instance when a client invokes a matching `create<METHOD>` method on the entity bean's home interface.

The entity Bean Provider's responsibility is to initialize the instance in the `ejbCreate<METHOD>` methods from the input arguments, using the get and set accessor methods, such that when the `ejbCreate<METHOD>` method returns, the persistent representation of the instance can be created. The entity Bean Provider is guaranteed that the values that will be initially returned by the instance's get methods for container-managed fields will be the Java language defaults (e.g. 0 for integer, null for pointers), except for collection-valued cmr-fields, which will have the empty collection (or set) as their value. The entity Bean Provider must not attempt to modify the values of cmr-fields in an `ejbCreate<METHOD>` method. This should be done in the `ejbPostCreate<METHOD>` method instead.

The entity object created by the `ejbCreate<METHOD>` method must have a unique primary key. This means that the primary key must be different from the primary keys of all the existing entity objects within the same home. However, it is legal to reuse the primary key of a previously removed entity object. The implementation of the Bean Provider's `ejbCreate<METHOD>` methods should be coded to return a null.^[35]

An `ejbCreate<METHOD>` method executes in the transaction context determined by the transaction attribute of the matching `create<METHOD>` method. The database insert operations are performed by the container within the same transaction context after the Bean Provider's `ejbCreate<METHOD>` method completes.

- `public void ejbPostCreate<METHOD>(...);`

For each `ejbCreate<METHOD>` method, there is a matching `ejbPostCreate<METHOD>` method that has the same input parameters but whose return type is `void`. The container invokes the matching `ejbPostCreate<METHOD>` method on an instance

[34] An entity bean has no `ejbCreate<METHOD>` and `ejbPostCreate<METHOD>` methods if it does not define any create methods in its home interface. Such an entity bean does not allow its clients to create new EJB objects. The entity bean restricts the clients to accessing entities that were created through direct database inserts.

[35] The above requirement is to allow the creation of an entity bean with bean-managed persistence by subclassing an entity bean with container-managed persistence.

after it invokes the `ejbCreate<METHOD>` method with the same arguments. The instance can discover the primary key by calling `getPrimaryKey` on its entity context object.

The entity object identity is available during the `ejbPostCreate<METHOD>` method. The instance may, for example, obtain the component interface of the associated entity object and pass it to another enterprise bean as a method argument.

The entity Bean Provider may use the `ejbPostCreate<METHOD>` to set the values of cmr-fields to complete the initialization of the entity bean instance.

An `ejbPostCreate<METHOD>` method executes in the same transaction context as the previous `ejbCreate<METHOD>` method.

- `public void ejbActivate();`

The container invokes this method on the instance when the container picks the instance from the pool and assigns it to a specific entity object identity. The `ejbActivate` method gives the entity bean instance the chance to acquire additional resources that it needs while it is in the ready state.

This method executes with an unspecified transaction context. The entity bean must not attempt to access its persistent state or relationships using the accessor methods during this method.

The instance can obtain the identity of the entity object via the `getPrimaryKey`, `getEJBLocalObject`, or `getEJBObject` method on the entity context. The instance can rely on the fact that the primary key and entity object identity will remain associated with the instance until the completion of `ejbPassivate` or `ejbRemove`.

- `public void ejbPassivate();`

The container invokes this method on an instance when the container decides to disassociate the instance from an entity object identity, and to put the instance back into the pool of available instances. The `ejbPassivate` method gives the instance the chance to release any resources that should not be held while the instance is in the pool. (These resources typically had been allocated during the `ejbActivate` method.)

This method executes with an unspecified transaction context. The entity bean must not attempt to access its persistent state or relationships using the accessor methods during this method.

The instance can still obtain the identity of the entity object via the `getPrimaryKey`, `getEJBLocalObject`, or `getEJBObject` method of the `EntityContext` interface.

- `public void ejbRemove();`

The container invokes the `ejbRemove` method on an entity bean instance in response to a client-invoked `remove` operation on the entity bean's home or component interface or as the result of a cascade-delete operation. The instance is in the ready state when `ejbRemove` is invoked and it will be entered into the pool when the method completes.

The entity Bean Provider can use the `ejbRemove` method to implement any actions that must be done before the entity object's persistent representation is removed.

The container synchronizes the instance's state before it invokes the `ejbRemove` method. This means that the state of the instance at the beginning of the `ejbRemove` method is the same as it would be at the beginning of a business method.

This method and the database delete operation(s) execute in the transaction context determined by the transaction attribute of the `remove` method that triggered the `ejbRemove` method.

The instance can still obtain the identity of the entity object via the `getPrimaryKey`, `getEJBLocalObject`, or `getEJBObject` method of the `EntityContext` interface.

After the entity Bean Provider's `ejbRemove` returns, and in the same transaction context, the container removes the entity bean from all relationships in which it participates before removing the entity object's persistent representation.

Since the instance will be entered into the pool, the state of the instance at the end of this method must be equivalent to the state of a passivated instance. This means that the instance must release any resource that it would normally release in the `ejbPassivate` method.

- `public void ejbLoad();`

When the container needs to synchronize the state of an enterprise bean instance with the entity object's persistent state, the container calls the `ejbLoad` method.

The entity Bean Provider can assume that the instance's persistent state has been loaded just before the `ejbLoad` method is invoked. It is the responsibility of the Bean Provider to use the `ejbLoad` method to recompute or initialize the values of any instance variables that depend on the entity bean's persistent state. In general, any transient state that depends on the persistent state of an entity bean should be recalculated using the `ejbLoad` method. The entity bean can use the `ejbLoad` method, for instance, to perform some computation on the values returned by the accessor methods (for example, uncompressing text fields).

This method executes in the transaction context determined by the transaction attribute of the business method or `ejbTimeout` method that triggered the `ejbLoad` method.

- `public void ejbStore();`

When the container needs to synchronize the state of the entity object's persistent state with the state of the enterprise bean instance, the container first calls the `ejbStore` method on the instance.

The entity Bean Provider should use the `ejbStore` method to update the instance using the accessor methods before its persistent state is synchronized. For example, the `ejbStore` method may perform compression of text before the text is stored in the database.

The Bean Provider can assume that after the `ejbStore` method returns, the persistent state of the instance is synchronized.

This method executes in the same transaction context as the previous `ejbLoad` or `ejbCreate` method invoked on the instance. All business methods or the `ejbTimeout` method invoked between the previous `ejbLoad` or `ejbCreate<METHOD>` method and this `ejbStore` method are also invoked in the same transaction context.

- `public <primary key type or collection> ejbFind<METHOD>(...);`

The Bean Provider of an entity bean with container-managed persistence does not write the finder (`ejbFind<METHOD>`) methods.

The finder methods are generated at the entity bean deployment time using the Container Provider's tools. The syntax for the Bean Provider's specification of finder methods is described in the document "*Java Persistence APP*" of this specification [2].

- `public <type> ejbHome<METHOD>(...);`

The container invokes this method on the instance when the container selects the instance to execute a matching client-invoked `<METHOD>` home method. The instance is in the pooled state (i.e., it is not assigned to any particular entity object identity) when the container selects

the instance to execute the `ejbHome<METHOD>` method on it, and it is returned to the pooled state when the execution of the `ejbHome<METHOD>` method completes.

The `ejbHome<METHOD>` method executes in the transaction context determined by the transaction attribute of the matching `<METHOD>` home method, as described in Section 13.6.2.

The entity Bean Provider provides the implementation of the `ejbHome<METHOD>` method. The entity bean must not attempt to access its persistent state or relationships using the accessor methods during this method because a home method is not specific to a particular bean instance.

- `public abstract <type> ejbSelect<METHOD>(...);`

The Bean Provider may provide zero or more select methods. A select method is a query method that is not directly exposed to the client in the home or component interface. The Bean Provider typically calls a select method within a business method.

The Bean Provider defines the select methods as `abstract` methods.

The select methods are generated at the entity bean deployment time using the Container Provider's tools.

The syntax for the specification of select methods is described in the document “*Java Persistence API*” of this specification [2].

The `ejbSelect<METHOD>` method executes in the transaction context determined by the transaction attribute of the invoking business method.

- `public void ejbTimeout(...);`

The container invokes the `ejbTimeout` method on an instance when a timer for the instance has expired. The `ejbTimeout` method notifies the instance of the time-based event and allows the instance to execute the business logic to handle it.

The `ejbTimeout` method executes in the transaction context determined by its transaction attribute.

8.5.3 Container's View

This subsection describes the container's view of the state management contract. The container must call the following methods:

- `public void setEntityContext(ec);`

The container invokes this method to pass a reference to the `EntityContext` interface to the entity bean instance. The container must invoke this method after it creates the instance, and before it puts the instance into the pool of available instances.

The container invokes this method with an unspecified transaction context. At this point, the `EntityContext` is not associated with any entity object identity.

- `public void unsetEntityContext();`

The container invokes this method when the container wants to reduce the number of instances in the pool. After this method completes, the container must not reuse this instance.

The container invokes this method with an unspecified transaction context.

- `public PrimaryKeyClass ejbCreate<METHOD>(...);`
`public void ejbPostCreate<METHOD>(...);`

The container invokes these two methods during the creation of an entity object as a result of a client invoking a `create<METHOD>` method on the entity bean's home interface.

The container invokes the `ejbCreate<METHOD>` method whose signature matches the `create<METHOD>` method invoked by the client.

Prior to invoking the `ejbCreate<METHOD>` method provided by the Bean Provider, the container must ensure that the values that will be initially returned by the instance's get methods for container-managed fields will be the Java language defaults (e.g. 0 for integer, null for pointers), except for collection-valued cmr-fields, which must have the empty collection (or set) as their value.

The container is responsible for calling the `ejbCreate<METHOD>` method, for obtaining the primary key fields of the newly created entity object persistent representation, and for creating an entity `EJBObject` reference and/or `EJBLocalObject` reference for the newly created entity object. The container must establish the primary key before it invokes the `ejbPostCreate<METHOD>` method.

The entity object created by the `ejbCreate<METHOD>` method must have a unique primary key. This means that the primary key must be different from the primary keys of all the existing entity objects within the same home. However, it is legal to reuse the primary key of a previously removed entity object. The container may, but is not required to, throw the `DuplicateKeyException` on the Bean Provider's attempt to create an entity object with a duplicate primary key^[36].

The container may create the representation of the entity in the database immediately, or it can defer it to a later time (for example to the time after the matching `ejbPostCreate<METHOD>` has been called, or to the end of the transaction), depending on the caching strategy that it uses.

The container then invokes the matching `ejbPostCreate<METHOD>` method with the same arguments on the instance to allow the instance to fully initialize itself. The instance can discover the primary key by calling the `getPrimaryKey` method on its entity context object. Finally, the container returns the entity object's remote interface (i.e., a reference to the entity `EJBObject`) to the client if the client is a remote client or the entity object's local interface (i.e., a reference to the entity `EJBLocalObject`) if the client is a local client.

The container must invoke the `ejbCreate<METHOD>` and `ejbPostCreate<METHOD>` methods and create the representation of the persistent instance in the database in the transaction context determined by the transaction attribute of the matching `create<METHOD>` method, as described in subsection 13.6.2.

- `public void ejbActivate();`

The container invokes this method on an entity bean instance at activation time (i.e., when the instance is taken from the pool and assigned to an entity object identity). The container must ensure that the primary key of the associated entity object is available to the instance if the instance invokes the `getPrimaryKey`, `getEJBLocalObject`, or `getEJBObject` method on its `EntityContext` interface.

The container invokes this method with an unspecified transaction context.

[36] Containers using optimistic caching strategies, for example, may rollback the transaction at a later point.

Note that instance is not yet ready for the delivery of a business method. The container must still invoke the `ejbLoad` method prior to a business method.

- `public void ejbPassivate();`

The container invokes this method on an entity bean instance at passivation time (i.e., when the instance is being disassociated from an entity object identity and moved into the pool). The container must ensure that the identity of the associated entity object is still available to the instance if the instance invokes the `getPrimaryKey`, `getEJBLocalObject`, or `getEJBObject` method on its entity context.

The container invokes this method with an unspecified transaction context.

Note that if the instance state has been updated by a transaction, the container must first invoke the `ejbStore` method on the instance before it invokes `ejbPassivate` on it.

- `public void ejbRemove();`

The container invokes the `ejbRemove` method in response to a client-invoked `remove` operation on the entity bean's home or component interface or as the result of a cascade-delete operation. The instance is in the ready state when `ejbRemove` is invoked and it will be entered into the pool when the method completes.

The container synchronizes the instance's state before it invokes the `ejbRemove` method. This means that the persistent state of the instance at the beginning of the `ejbRemove` method is the same as it would be at the beginning of a business method (i.e., if the instance is not already synchronized from the state in the database, the container must invoke `ejbLoad` before it invokes `ejbRemove`).

The container must ensure that the identity of the associated entity object is still available to the instance in the `ejbRemove` method (i.e., the instance can invoke the `getPrimaryKey`, `getEJBLocalObject`, or `getEJBObject` method on its `EntityContext` in the `ejbRemove` method).

After the entity Bean Provider's `ejbRemove` method returns, and in the same transaction context, the container removes the entity bean instance from all relationships in which it participates and then removes the entity object's persistent representation.

The container may delete the representation of the entity in the database immediately, or it can defer it to a later time (for example to the end of the transaction), depending on the caching strategy that it uses.

The container must ensure that the `ejbRemove` method and database delete operations are performed in the transaction context determined by the transaction attribute of the invoked `remove` method, as described in subsection 13.6.2.

- `public void ejbLoad();`

When the container needs to synchronize the state of an enterprise bean instance with the entity object's state in the database, the container calls the `ejbLoad` method. Depending on its caching strategy, the container may first read the entity object's state from the database, before invoking the `ejbLoad` method, or it may use a lazy loading strategy in making this state visible to the instance.

The exact times that the container invokes `ejbLoad` depend on the configuration of the component and the container, and are not defined by the EJB architecture. Typically, the container will call `ejbLoad` before the first business method within a transaction or before invoking the `ejbTimeout` method on an instance.

The container must invoke this method in the transaction context determined by the transaction attribute of the business method or `ejbTimeout` method that triggered the `ejbLoad` method.

- `public void ejbStore();`

When the container needs to synchronize the state of the entity object in the database with the state of the enterprise bean instance, the container calls the `ejbStore` method on the instance. This synchronization always happens at the end of a transaction, unless the bean is specified as read-only (see section 8.5.4). However, the container may also invoke this method when it passivates the instance in the middle of a transaction, or when it needs to transfer the most recent state of the entity object to another instance for the same entity object in the same transaction.

The container must invoke this method in the same transaction context as the previous `ejbLoad`, `ejbCreate<METHOD>`, or `ejbTimeout` method invoked on the instance. All business methods or the `ejbTimeout` method invoked between the previous `ejbLoad` or `ejbCreate <METHOD>` method and this `ejbStore` method are also invoked in the same transaction context.

After the `ejbStore` method returns, the container may store the persistent state of the instance to the database, depending on its caching strategy. If the container uses a lazy storing caching strategy, it is the container's responsibility to write the representation of the persistent object to the database in the same transaction context as that of the `ejbStore` method.

- `public <primary key type or collection> ejbFind<METHOD>(...);`

The implementation of the `ejbFind<METHOD>` method is supplied by the container.

The container invokes the `ejbFind<METHOD>` method on an instance when a client invokes a matching `find<METHOD>` method on the entity bean's home interface. The container must pick an instance that is in the pooled state (i.e., the instance is not associated with any entity object identity) for the execution of the `ejbFind<METHOD>` method. If there is no instance in the pooled state, the container creates one and calls the `setEntityContext` method on the instance before dispatching the finder method.

The container must invoke the `ejbFind<METHOD>` method in the transaction context determined by the transaction attribute of the matching `find` method, as described in subsection 13.6.2.

The container is responsible for ensuring that updates to the states of all entity beans in the same transaction context as the `ejbFind<METHOD>` method and whose abstract schema types are accessed in the method's EJB QL query are visible in the results of the `ejbFind<METHOD>` method. Before invoking the `ejbFind<METHOD>` method, the container must first synchronize the state of those entity bean instances by invoking the `ejbStore` method on them. This requirement does not apply to the `ejbFindByPrimaryKey` method. The results of the `ejbFindByPrimaryKey` method, however, must reflect the entities that have been created or removed within the same transaction context.

After the `ejbFind<METHOD>` method completes, the instance remains in the pooled state. The container may, but is not required to, immediately activate the objects that were located by the finder using the transition through the `ejbActivate` method.

If the `ejbFind<METHOD>` method is declared to return a single primary key, the container creates an entity `EJBObject` (`EJBLocalObject`) reference for the primary key and returns it to the client (local client). If the `ejbFind<METHOD>` method is declared to return a collection

of primary keys, the container creates a collection of entity EJBObject (EJBLocalObject) references for the primary keys returned from the `ejbFind<METHOD>` method, and returns the collection to the client (local client).

The implementations of the finder methods are generated at the entity bean deployment time using the Container Provider's tools.

- `public <type> ejbSelect<METHOD>(...);`

A select method is a query method that is not directly exposed to the client in the home or component interface. The Bean Provider typically calls a select method within a business method or home method.

A select method executes in the transaction context determined by the transaction attribute of the invoking business method.

The container is responsible for ensuring that all updates to the states of all entity beans in the same transaction context as the `ejbSelect<METHOD>` method and whose abstract schema types are accessed in the EJB QL query for the `ejbSelect<METHOD>` method are visible in the results of the `ejbSelect<METHOD>` method by invoking the `ejbStore` method on those entity bean instances.

The implementations of the select methods are generated at the entity bean deployment time using the Container Provider's tools.

- `public <type> ejbHome<METHOD>(...);`

The container invokes the `ejbHome<METHOD>` method on an instance when a client invokes a matching `<METHOD>` home method on the entity bean's home interface. The container must pick an instance that is in the pooled state (i.e., the instance is not associated with any entity object identity) for the execution of the `ejbHome<METHOD>` method. If there is no instance in the pooled state, the container creates one and calls the `setEntityContext` method on the instance before dispatching the home method.

After the `ejbHome<METHOD>` method completes, the instance remains in the pooled state.

The container must invoke the `ejbHome<METHOD>` method in the transaction context determined by the transaction attribute of the matching `<METHOD>` home method, as described in subsection 13.6.2.

- `public void ejbTimeout(...);`

The container invokes the `ejbTimeout` method on the instance when a timer with which the entity has been registered expires. If there is no suitable instance in the ready state, the container must activate an instance, invoking the `ejbActivate` method and transitioning it to the ready state.

The container invokes the `ejbTimeout` method in the context of a transaction determined by its transaction attribute.

8.5.4 Read-only Entity Beans

Compliant implementations of this specification may optionally support read-only entity beans. A read-only entity bean is an entity bean whose instances are not intended to be updated and/or created by the application. Read-only beans are best suited for situations where the underlying data never changes or changes infrequently.

Containers that support read-only beans do not call the `ejbStore` method on them. The `ejbLoad` method should typically be called by the container when the state of the bean instance is initially loaded from the database, or at designated refresh intervals.^[37]

If a read-only bean is used, the state of such a bean should not be updated by the application, and the behavior is unspecified if this occurs.^[38]

Read-only beans are designated by vendor-specific means that are outside the scope of this specification, and their use is therefore not portable.

8.5.5 The EntityContext Interface

A container provides the entity bean instances with an `EntityContext`, which gives the entity bean instance access to the instance's context maintained by the container. The `EntityContext` interface has the following methods:

- The `getEJBObject` method returns the entity bean's remote interface.
- The `getEJBHome` method returns the entity bean's remote home interface.
- The `getEJBLocalObject` method returns the entity bean's local interface.
- The `getEJBLocalHome` method returns the entity bean's local home interface.
- The `getCallerPrincipal` method returns the `java.security.Principal` that identifies the invoker.
- The `isCallerInRole` method tests if the entity bean instance's caller has a particular role.
- The `setRollbackOnly` method allows the instance to mark the current transaction such that the only outcome of the transaction is a rollback.
- The `getRollbackOnly` method allows the instance to test if the current transaction has been marked for rollback.
- The `getPrimaryKey` method returns the entity bean's primary key.
- The `getTimerService` method returns the `javax.ejb.TimerService` interface.
- The `getUserTransaction` method returns the `javax.transaction.UserTransaction` interface. Entity bean instances must not call this method.

[37] The ability to refresh the state of a read-only bean and the intervals at which such refresh occurs are vendor-specific.

[38] For example, an implementation might choose to ignore such updates or to disallow them.

- The `lookup` method enables the entity bean to look up its environment entries in the JNDI naming context.

8.5.6 Operations Allowed in the Methods of the Entity Bean Class

Table 5 defines the methods of an entity bean class in which the enterprise bean instances can access the methods of the `javax.ejb.EntityContext` interface, the `java:comp/env` environment naming context, resource managers, `TimerService` and `Timer` methods, the `EntityManager` and `EntityManagerFactory` methods, and other enterprise beans.

If an entity bean instance attempts to invoke a method of the `EntityContext` interface, and the access is not allowed in Table 5, the container must throw the `java.lang.IllegalStateException`.

If a entity bean instance attempts to invoke a method of the `TimerService` or `Timer` interface and the access is not allowed in Table 5, the container must throw the `java.lang.IllegalStateException`.

If an entity bean instance attempts to access a resource manager, an enterprise bean, an entity manager or entity manager factory, and the access is not allowed in Table 5, the behavior is undefined by the EJB architecture.

Table 5 Operations Allowed in the Methods of an Entity Bean

Bean method	Bean method can perform the following operations
<code>constructor</code>	-
<code>setEntityContext</code> <code>unsetEntityContext</code>	<code>EntityContext</code> methods: <i>getEJBHome</i> , <i>getEJBLocalHome</i> , <i>lookup</i> JNDI access to <code>java:comp/env</code>
<code>ejbCreate</code>	<code>EntityContext</code> methods: <i>getEJBHome</i> , <i>getEJBLocalHome</i> , <i>getCallerPrincipal</i> , <i>getRollbackOnly</i> , <i>isCallerInRole</i> , <i>setRollbackOnly</i> , <i>getTimerService</i> , <i>lookup</i> JNDI access to <code>java:comp/env</code> Resource manager access Enterprise bean access EntityManagerFactory access EntityManager access
<code>ejbPostCreate</code>	<code>EntityContext</code> methods: <i>getEJBHome</i> , <i>getEJBLocalHome</i> , <i>getCallerPrincipal</i> , <i>getRollbackOnly</i> , <i>isCallerInRole</i> , <i>setRollbackOnly</i> , <i>getEJBObject</i> , <i>getEJBLocalObject</i> , <i>getPrimaryKey</i> , <i>getTimerService</i> , <i>lookup</i> JNDI access to <code>java:comp/env</code> Resource manager access Enterprise bean access Timer service or Timer methods EntityManagerFactory access EntityManager access

Table 5 Operations Allowed in the Methods of an Entity Bean

Bean method	Bean method can perform the following operations
ejbRemove	<p>EntityContext methods: <i>getEJBHome</i>, <i>getEJBLocalHome</i>, <i>getCallerPrincipal</i>, <i>getRollbackOnly</i>, <i>isCallerInRole</i>, <i>setRollbackOnly</i>, <i>getEJBObject</i>, <i>getEJBLocalObject</i>, <i>getPrimaryKey</i>, <i>getTimerService</i>, <i>lookup</i></p> <p>JNDI access to java:comp/env</p> <p>Resource manager access</p> <p>Enterprise bean access</p> <p>Timer service or Timer methods</p> <p>EntityManagerFactory access</p> <p>EntityManager access</p>
ejbHome	<p>EntityContext methods: <i>getEJBHome</i>, <i>getEJBLocalHome</i>, <i>getCallerPrincipal</i>, <i>getRollbackOnly</i>, <i>isCallerInRole</i>, <i>setRollbackOnly</i>, <i>getTimerService</i>, <i>lookup</i></p> <p>JNDI access to java:comp/env</p> <p>Resource manager access</p> <p>Enterprise bean access</p> <p>EntityManagerFactory access</p> <p>EntityManager access</p>
ejbActivate ejbPassivate	<p>EntityContext methods: <i>getEJBHome</i>, <i>getEJBLocalHome</i>, <i>getEJBObject</i>, <i>getEJBLocalObject</i>, <i>getPrimaryKey</i>, <i>getTimerService</i>, <i>lookup</i></p> <p>JNDI access to java:comp/env</p>
ejbLoad ejbStore	<p>EntityContext methods: <i>getEJBHome</i>, <i>getEJBLocalHome</i>, <i>getCallerPrincipal</i>, <i>getRollbackOnly</i>, <i>isCallerInRole</i>, <i>setRollbackOnly</i>, <i>getEJBObject</i>, <i>getEJBLocalObject</i>, <i>getPrimaryKey</i>, <i>getTimerService</i>, <i>lookup</i></p> <p>JNDI access to java:comp/env</p> <p>Resource manager access</p> <p>Enterprise bean access</p> <p>Timer service or Timer methods</p> <p>EntityManagerFactory access</p> <p>EntityManager access</p>
business method from component interface	<p>EntityContext methods: <i>getEJBHome</i>, <i>getEJBLocalHome</i>, <i>getCallerPrincipal</i>, <i>getRollbackOnly</i>, <i>isCallerInRole</i>, <i>setRollbackOnly</i>, <i>getEJBObject</i>, <i>getEJBLocalObject</i>, <i>getPrimaryKey</i>, <i>getTimerService</i>, <i>lookup</i></p> <p>JNDI access to java:comp/env</p> <p>Resource manager access</p> <p>Enterprise bean access</p> <p>Timer service or Timer methods</p> <p>EntityManagerFactory access</p> <p>EntityManager access</p>
ejbTimeout	<p>EntityContext methods: <i>getEJBHome</i>, <i>getEJBLocalHome</i>, <i>getRollbackOnly</i>, <i>setRollbackOnly</i>, <i>getCallerPrincipal</i>, <i>isCallerInRole</i>, <i>getEJBObject</i>, <i>getEJBLocalObject</i>, <i>getPrimaryKey</i>, <i>getTimerService</i>, <i>lookup</i></p> <p>JNDI access to java:comp/env</p> <p>Resource manager access</p> <p>Enterprise bean access</p> <p>Timer service or Timer methods</p> <p>EntityManagerFactory access</p> <p>EntityManager access</p>

Additional restrictions:

- The `getRollbackOnly` and `setRollbackOnly` methods of the `EntityContext` interface should be used only in the enterprise bean methods that execute in the context of a transaction. The container must throw the `java.lang.IllegalStateException` if the methods are invoked while the instance is not associated with a transaction.

Reasons for disallowing operations:

- Invoking the `getEJBObject`, `getEJBLocalObject`, and `getPrimaryKey` methods is disallowed in the entity bean methods in which there is no entity object identity associated with the instance.
- Invoking the `getEJBObject` and `getEJBHome` methods is disallowed if the entity bean does not define a remote client view.
- Invoking the `getEJBLocalObject` and `getEJBLocalHome` methods is disallowed if the entity bean does not define a local client view.
- Invoking the `getRollbackOnly` and `setRollbackOnly` methods is disallowed in the entity bean methods for which the container does not have a meaningful transaction context.
- Accessing resource managers and enterprise beans, including accessing the persistent state of an entity bean instance, is disallowed in the entity bean methods for which the container does not have a meaningful transaction context or client security context.

8.5.7 Finder Methods

An entity bean's home interface defines one or more `finder` methods^[39], one for each way to find an entity object or collection of entity objects within the home. The name of each finder method starts with the prefix "find", such as `findLargeAccounts`. The arguments of a finder method are used in the implementation of the query for the finder method to locate the requested entity objects.

Every finder method except `findByPrimaryKey(key)` must be associated with a `query` element in the deployment descriptor. The entity Bean Provider declaratively specifies the EJB QL finder query and associates it with the finder method in the deployment descriptor. A finder method is normally characterized by an EJB QL query string specified in the `query` element. EJB QL is described in Chapter 9. A compliant implementation of this specification is required to support EJB QL as defined in Chapter 9 for use with finder methods.

In the case that both the remote home interface and local home interface define a finder method with the same name and argument types, the EJB QL query string specified by the `query` element defines the semantics of both methods.

[39] The `findByPrimaryKey` method is mandatory for all entity beans.

8.5.7.1 Single-Object Finder Methods

Some finder methods (such as `findByPrimaryKey`) are designed to return at most one entity object. For single-object finders, the result type of a `find<METHOD>method` defined in the entity bean's remote home interface is the entity bean's remote interface, and the result type of the `find<METHOD>method` defined in the entity bean's local home interface is the entity bean's local interface.

The following code illustrates the definition of a single-object finder defined on the remote home interface.

```
// Entity's home interface
public interface AccountHome extends javax.ejb.EJBHome {
    ...
    Account findByPrimaryKey(AccountPrimaryKey primkey)
        throws FinderException, RemoteException;
    ...
}
```

Note that a finder method defined on the local home interface must not throw the `RemoteException`.

In general, when defining a single-object finder method other than `findByPrimaryKey`, the entity Bean Provider should be sure that the finder method will always return only a single entity object. This may occur, for example, if the EJB QL query string that is used to specify the finder query includes an equality test on the entity bean's primary key fields. If the entity Bean Provider uses an unknown primary key class (see Section 8.8.3), the Bean Provider will typically define the finder method as a multi-object finder.

Note that a single-object finder method may return a null value. If the result set of the query consists of a single null value, the container must return the null value as the result of the method. If the result set of a query for a single-object finder method contains more than one value (whether non-null, null, or a combination), the container must throw the `FinderException` from the finder method. If the result set of the query contains no values, the container must throw the `ObjectNotFoundException`.

8.5.7.2 Multi-Object Finder Methods

Some finder methods are designed to return multiple entity objects. For multi-object finders defined on the entity bean's local home interface, the result type of the `find<METHOD>method` is a collection of objects implementing the entity bean's local interface. For multi-object finders defined on the entity bean's remote home interface, the result type of the `find<METHOD>method` is a collection of objects implementing the entity bean's remote interface.

The Bean Provider uses the Java™ 2 `java.util.Collection` interface to define a collection type for the result type of a finder method for an entity bean with container-managed persistence.

The collection of values returned by the container may contain duplicates if `DISTINCT` is not specified in the `SELECT` clause of the query for the finder method.

The collection of values returned by the container may contain null values if the finder method returns the values of a cmr-field and null values are not eliminated by the query.

A portable client program must use the `PortableRemoteObject.narrow` method to convert the objects contained in the collections returned by a finder method on the entity bean's remote home interface to the entity bean's remote interface type.

The following is an example of a multi-object finder method defined on the remote home interface:

```
// Entity's home interface
public interface AccountHome extends javax.ejb.EJBHome {
    ...
    java.util.Collection findLargeAccounts(double limit)
        throws FinderException, RemoteException;
    ...
}
```

Note that if this finder method were defined on the local home interface, it would not throw the RemoteException.

8.5.8 Select Methods

Select methods are query methods for use by the Bean Provider within an entity bean instance. Unlike finder methods, select methods are not specified in the entity bean's home interface. A select method is an abstract method defined by the Bean Provider on an entity bean class. A select method must not be exposed in the home or component interface of an entity bean.

The semantics of a select method, like those of a finder method, are defined by an EJB QL query string. A select method is similar to a finder method, but unlike a finder method, but it can return values that correspond to any cmp- or cmr-field type.

Every select method must be associated with a `query` element in the deployment descriptor. The entity Bean Provider declaratively specifies the EJB QL query and associates it with the select method in the deployment descriptor. A select method is normally characterized by an EJB QL query string specified in the `query` element. EJB QL is described in Chapter 9. A compliant implementation of this specification is required to support EJB QL as defined in Chapter 9 for use with select methods.

Typically an `ejbSelect<METHOD>` method that returns entity objects returns these as `EJBLocalObjects`. If the `ejbSelect<METHOD>` method returns an `EJBObject` or collection of `EJBObjects`, the Bean Provider must specify the value of the `result-type-mapping` element in the `query` deployment descriptor element for the select method as `Remote`.

An `ejbSelect<METHOD>` is not based on the identity of the entity bean instance on which it is invoked. However, the Bean Provider can use the primary key of an entity bean as an argument to an `ejbSelect<METHOD>` to define a query that is logically scoped to a particular entity bean instance.

The following table illustrates the semantics of finder and select methods.

Table 6 Comparison of Finder and Select Methods

	Finder methods	Select methods
method	<code>find<METHOD></code>	<code>ejbSelect<METHOD></code>
visibility	exposed to client	internal to entity bean class
instance	arbitrary bean instance in pooled state	instance: current instance (could be bean instance in pooled state or ready state)
return value	EJBObjects or EJBLocalObjects of the same type as the entity bean	EJBObjects, EJBLocalObjects, or cmp-field types

8.5.8.1 Single-Object Select Methods

Some select methods are designed to return at most one value. In general, when defining a single-object select method, the entity Bean Provider must be sure that the select method will always return only a single object or value. If the query specified by the select method returns multiple values of the designated type, the container must throw the `FinderException`.

Note that a single-object select method may return a null value. If the result set of the query consists of a single null value, the container must return the null value as the result of the method. If the result set of a query for a single-object select method contains more than one value (whether non-null, null, or a combination), the container must throw the `FinderException` from the select method. If the result set of the query contains no values, the container must throw the `ObjectNotFoundException`.

The Bean Provider will typically define a select method as a multi-object select method.

8.5.8.2 Multi-Object Select Methods

Some select methods are designed to return multiple values. For these multi-object select methods, the result type of the `ejbSelect<METHOD>` method is a collection of objects.

The Bean Provider uses the Java™ 2 `java.util.Collection` interface or `java.util.Set` interface to define a collection type for the result type of a select method. The type of the elements of the collection is determined by the type of the `SELECT` clause of the corresponding EJB QL query. If the Bean Provider uses the `java.util.Collection` interface, the collection of values returned by the container may contain duplicates if `DISTINCT` is not specified in the `SELECT` clause of the query. If a query for a select method whose result type is `java.util.Set` does not specify `DISTINCT` in its `SELECT` clause, the container must interpret the query as if `SELECT DISTINCT` had been specified.

The collection of values returned by the container may contain null values if the select method returns the values of a `cmr-field` or `cmp-field` and null values are not eliminated by the query.

The following is an example of a multi-object select method definition in the `OrderBean` class:

```
// OrderBean implementation class
public abstract class OrderBean implements javax.ejb.EntityBean{
    ...
    public abstract java.util.Collection
       .ejbSelectAllOrderedProducts(Customer customer)
        throws FinderException;
    // internal finder method to find all products ordered
```

8.5.9 Timer Notifications

An entity bean can be registered with the EJB timer service for time-based event notifications if it implements the `javax.ejb.TimedObject` interface. The container invokes the bean instance's `ejbTimeout` method when a timer for the bean has expired. See Chapter 18, "Timer Service".

8.5.10 Standard Application Exceptions for Entities

The EJB specification defines the following standard application exceptions:

- `javax.ejb.CreateException`
- `javax.ejb.DuplicateKeyException`
- `javax.ejb.FinderException`
- `javax.ejb.ObjectNotFoundException`
- `javax.ejb.RemoveException`

This section describes the use of these exceptions by entity beans with container-managed persistence.

8.5.10.1 CreateException

From the client's perspective, a `CreateException` (or a subclass of `CreateException`) indicates that an application level error occurred during a `create<METHOD>` operation. If a client receives this exception, the client does not know, in general, whether the entity object was created but not fully initialized, or not created at all. Also, the client does not know whether or not the transaction has been marked for rollback. (However, the client may determine the transaction status using the `UserTransaction` interface or the `setRollbackOnly` method of the `EJBContext` interface.)

Both the container and the Bean Provider may throw the `CreateException` (or subclass of `CreateException`) from the `create<METHOD>`, `ejbCreate<METHOD>` and `ejbPostCreate<METHOD>` methods to indicate an application-level error from the create or initialization operation. Optionally, the container or Bean Provider may mark the transaction for rollback before throwing this exception.

The container or Bean Provider is encouraged to mark the transaction for rollback only if data integrity would be lost if the transaction were committed by the client. Typically, when a `CreateException` is thrown, it leaves the database in a consistent state, allowing the client to recover. For example, the `ejbCreate<METHOD>` method may throw the `CreateException` to indicate that some of the arguments to the `create<METHOD>` method are invalid.

The container treats the `CreateException` as any other application exception. See Section 14.3.

8.5.10.2 DuplicateKeyException

The `DuplicateKeyException` is a subclass of `CreateException`. It may be thrown by the container to indicate to the client or local client that the entity object cannot be created because an entity object with the same key already exists. The unique key causing the violation may be the primary key, or another key defined in the underlying database.

Normally, the container should not mark the transaction for rollback before throwing the exception.

When the client or local client receives a `DuplicateKeyException`, the client knows that the entity was not created, and that the transaction has not typically been marked for rollback.

8.5.10.3 FinderException

From the client's perspective, a `FinderException` (or a subclass of `FinderException`) indicates that an application level error occurred during the `find` operation. Typically, the transaction has not been marked for rollback because of the `FinderException`.

The container throws the `FinderException` (or subclass of `FinderException`) from the implementation of a `finder` or `select` method to indicate an application-level error in the `finder` or `select` method. The container should not, typically, mark the transaction for rollback before throwing the `FinderException`.

The container treats the `FinderException` as any other application exception. See Section 14.3.

8.5.10.4 ObjectNotFoundException

The `ObjectNotFoundException` is a subclass of `FinderException`. The container throws the `ObjectNotFoundException` from the implementation of a `finder` or `select` method to indicate that the requested object does not exist.

Only single-object `finder` or `select` methods (see Subsections 8.5.7 and 8.5.8) should throw this exception. Multi-object `finder` or `select` methods must not throw this exception. Multi-object `finder` or `select` methods should return an empty collection as an indication that no matching objects were found.

8.5.10.5 RemoveException

From the client's perspective, a `RemoveException` (or a subclass of `RemoveException`) indicates that an application level error occurred during a `remove` operation. If a client receives this exception, the client does not know, in general, whether the entity object was removed or not. The client also does not know if the transaction has been marked for rollback. (However, the client may determine the transaction status using the `UserTransaction` interface.)

The container or Bean Provider throws the `RemoveException` (or subclass of `RemoveException`) from a `remove` method to indicate an application-level error from the entity object removal operation. Optionally, the container or Bean Provider may mark the transaction for rollback before throwing this exception.

The container or Bean Provider is encouraged to mark the transaction for rollback only if data integrity would be lost if the transaction were committed by the client. Typically, when a `RemoveException` is thrown, it leaves the database in a consistent state, allowing the client to recover.

The container treats the `RemoveException` as any other application exception. See Section 14.3.

8.5.11 Commit Options

The Entity Bean protocol is designed to give the container the flexibility to select the disposition of the instance state at transaction commit time. This flexibility allows the container to optimally manage the association of an entity object identity with the enterprise bean instances.

The container can select from the following commit-time options:

- **Option A:** The container caches a “ready” instance between transactions. The container knows that the bean instance has exclusive access to the state of the object in the persistent storage. Therefore, the container does not have to synchronize the instance's state from the persistent storage at the beginning of the next transaction or have to verify that the instance's state is in sync with the persistent storage at the beginning of the next transaction.
- **Option B:** The container caches a “ready” instance between transactions. In contrast to Option A, in this option the instance may not have exclusive access to the state of the object in the persistent storage. Therefore, the container must synchronize the instance's state from the persistent storage at the beginning of the next transaction if the instance's state in the persistent storage has changed. Containers using optimistic concurrency control strategies may instead choose to rollback the transaction if this invariant has not been met: The container must ensure that in order for a transaction to be successfully committed, the transaction must only operate on instance data that is in sync with the persistent storage at the beginning of the transaction.
- **Option C:** The container does not cache a “ready” instance between transactions. The container returns the instance to the pool of available instances after a transaction has completed.

Variants of these strategies that capture the same semantics from the Bean Provider's viewpoint may be employed, e.g., to optimize data access.

The following illustrative lazy loading strategies are consistent with the intent of these requirements:

- If `ejbLoad` is called at the beginning of the transaction without the instance's persistent state having been loaded from the persistent storage, the persistent state must be faulted in when `ejbLoad` causes the bean's getter accessor methods to be invoked. If the `ejbLoad` method is empty, data may be faulted in as needed in the course of executing the business methods of the bean.
- If the instance's persistent state is cached between transactions, `ejbLoad` need not be called and persistent data need not be faulted in from the persistent storage (unless it has not previously been accessed). In this case, because `ejbLoad` has been previously called when the instance was entered into the ready state for the first time, and because the bean instance's state is consistent with its persistent state, there is no need to call `ejbLoad` unless the instance's state in the persistent storage has changed. In this case, the container must ensure that in order for the transaction to be successfully committed, the instance's persistent state was in sync with the persistent storage at the beginning of the transaction.

The following table provides a summary of the commit-time options.

Table 7 Summary of Commit-Time Options

	Write instance state to database	Instance stays ready	Instance state remains valid
Option A	Yes	Yes	Yes
Option B	Yes	Yes	No
Option C	Yes	No	No

Note that the container synchronizes the instance's state with the persistent storage at transaction commit for all three options.

The selection of the commit option is transparent to the entity bean implementation—the entity bean will work correctly regardless of the commit-time option chosen by the container. The Bean Provider writes the entity bean in the same way.

Note: The Bean Provider relies on the `ejbLoad` method to be invoked in order to resynchronize the bean's transient state with its persistent state. It is the responsibility of the container to call the `ejbLoad` method at the beginning of a new transaction if the bean instance's persistent data has changed.^[40]

[40] It is consistent with this specification to provide options for this refresh to be deferred or avoided in the case of read-only beans.

8.5.12 Concurrent Access from Multiple Transactions

When writing the entity bean business methods, the Bean Provider does not have to worry about concurrent access from multiple transactions. The Bean Provider may assume that the container will ensure appropriate synchronization for entity objects that are accessed concurrently from multiple transactions.

The container typically uses one of the following implementation strategies to achieve proper synchronization. (These strategies are illustrative, not prescriptive.)

- The container activates multiple instances of the entity bean, one for each transaction in which the entity object is being accessed. The transaction synchronization is performed by the underlying database during the accessor method calls performed by the business methods, the `ejbTimeout` method, and by the `ejbLoad`, `ejbCreate<METHOD>`, `ejbStore`, and `ejbRemove` methods. The commit-time options B and C in Subsection 8.5.11 apply to this type of container.

Figure 16 Multiple Clients Can Access the Same Entity Object Using Multiple Instances

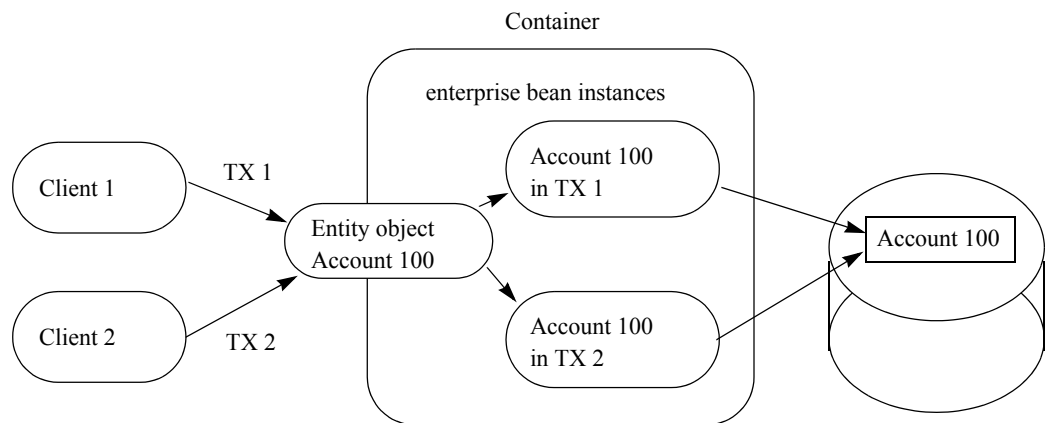

With this strategy, the type of lock acquired by `ejbLoad` or `get` accessor method (if a lazy loading cache management strategy is used) leads to a trade-off. If `ejbLoad` or the accessor method acquires an exclusive lock on the instance's state in the database, the throughput of read-only transactions could be impacted. If `ejbLoad` or the accessor method acquires a shared lock and the instance is updated, then either `ejbStore` or a `set` accessor method will need to promote the lock to an exclusive lock (which may cause a deadlock if it happens concurrently under multiple transactions), or, if the container uses an optimistic cache concurrency control strategy, the container will need to validate the state of the cache against the database at transaction commit (which may result in a rollback of the transaction).

It is expected that containers will provide deployment-time configuration options that will allow control to be exercised over the logical transaction isolation levels that their caching strategies provide.

- The container acquires exclusive access to the entity object's state in the database. The container activates a single instance and serializes the access from multiple transactions to this instance. The commit-time option A in Subsection 8.5.11 applies to this type of container.

Figure 17 Multiple Clients Can Access the Same Entity Object Using Single Instance

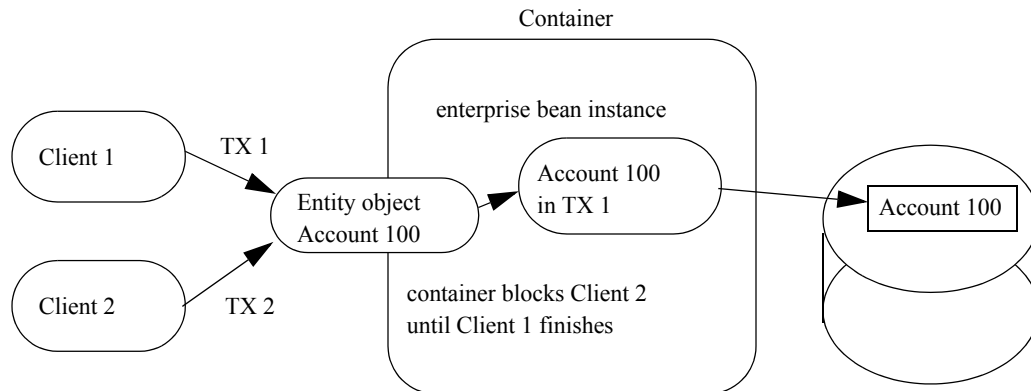

8.5.13 Non-reentrant and Re-entrant Instances

An entity Bean Provider can specify that an entity bean is non-reentrant. If an instance of a non-reentrant entity bean executes a client request in a given transaction context, and another request with the same transaction context arrives for the same entity object, the container will throw an exception to the second request. This rule allows the Bean Provider to program the entity bean as single-threaded, non-reentrant code.

The functionality of entity beans with container-managed persistence may require loopbacks in the same transaction context. An example of a loopback is when the client calls entity object A, A calls entity object B, and B calls back A in the same transaction context. The entity bean's method invoked by the loopback shares the current execution context (which includes the transaction and security contexts) with the Bean's method invoked by the client.

If the entity bean is specified as non-reentrant in the deployment descriptor, the container must reject an attempt to re-enter the instance via the entity bean's component interface while the instance is executing a business method. (This can happen, for example, if the instance has invoked another enterprise bean, and the other enterprise bean tries to make a loopback call.) If the attempt is made to reenter the instance through the remote interface, the container must throw the `java.rmi.RemoteException` to the caller. If the attempt is made to reenter the instance through the local interface, the container must throw the `javax.ejb.EJBException` to the caller. The container must allow the call if the Bean's deployment descriptor specifies that the entity bean is re-entrant.

Re-entrant entity beans must be programmed and used with caution. First, the Bean Provider must code the entity bean with the anticipation of a loopback call. Second, since the container cannot, in general, tell a loopback from a concurrent call from a different client, the client programmer must be careful to avoid code that could lead to a concurrent call in the same transaction context.

Concurrent calls in the same transaction context targeted at the same entity object are illegal and may lead to unpredictable results. Since the container cannot, in general, distinguish between an illegal concurrent call and a legal loopback, application programmers are encouraged to avoid using loopbacks. Entity beans that do not need callbacks should be marked as non-reentrant in the deployment descriptor, allowing the container to detect and prevent illegal concurrent calls from clients.

8.6 Responsibilities of the Enterprise Bean Provider

This section describes the responsibilities of an entity Bean Provider to ensure that an entity bean with container-managed persistence can be deployed in any EJB container.

8.6.1 Classes and Interfaces

The entity Bean Provider is responsible for providing the following class files:

- Entity bean class and any dependent classes
- Primary key class
- Entity bean's remote interface and entity bean's remote home interface, if the entity bean provides a remote client view
- Entity bean's local interface and local home interface, if the entity bean provides a local client view

The Bean Provider must provide a remote interface and a remote home interface or a local interface and a local home interface for the bean. The Bean Provider may provide a remote interface, remote home interface, local interface, and local home interface for the bean. Other combinations are not allowed.

8.6.2 Enterprise Bean Class

The following are the requirements for an entity bean class:

The class must implement, directly or indirectly, the `javax.ejb.EntityBean` interface.

The class may implement, directly or indirectly, the `javax.ejb.TimerObject` interface.

The class must be defined as `public` and must be `abstract`. The class must be a top level class.

The class must define a public constructor that takes no arguments.

The class must not define the `finalize()` method.

The class may, but is not required to, implement the entity bean's component interface^[41]. If the class implements the entity bean's component interface, the class must provide no-op implementations of the methods defined by that interface. The container will never invoke these methods on the bean instances at runtime.

The entity bean class must implement the business methods, and the `ejbCreate<METHOD>` and `ejbPostCreate<METHOD>` methods as described later in this section.

The entity bean class must implement the `ejbHome<METHOD>` methods that correspond to the home business methods specified in the bean's home interface. These methods are executed on an instance in the pooled state; hence they must not access state that is particular to a specific bean instance (e.g., the accessor methods for the bean's abstract persistence schema must not be used by these methods).

The entity bean class must implement the get and set accessor methods of the bean's abstract persistence schema as abstract methods.

The entity bean class may have superclasses and/or superinterfaces. If the entity bean has superclasses, the business methods, the `ejbCreate<METHOD>` and `ejbPostCreate<METHOD>` methods, and the methods of the `EntityBean` interface and/or the `TimedObject` interface may be implemented in the enterprise bean class or in any of its superclasses.

The entity bean class is allowed to implement other methods (for example helper methods invoked internally by the business methods) in addition to the methods required by the EJB specification.

The entity bean class does not implement the finder methods. The implementations of the finder methods are provided by the container.

The entity bean class must implement any `ejbSelect<METHOD>` methods as abstract methods.

8.6.3 Dependent Value Classes

The following are the requirements for a dependent value class:

The class must be defined as `public` and must not be `abstract`.

The class must be serializable.

8.6.4 ejbCreate<METHOD> Methods

The entity bean class must implement the `ejbCreate<METHOD>` methods that correspond to the `create<METHOD>` methods specified in the entity bean's home interface or local home interface.

[41] If the entity bean class does implement the component interface, care must be taken to avoid passing of `this` as a method argument or result. This potential error can be avoided by choosing not to implement the component interface in the entity bean class.

The entity bean class may define zero or more `ejbCreate<METHOD>` methods whose signatures must follow these rules:

The method name must have `ejbCreate` as its prefix.

The method must be declared as `public`.

The method must not be declared as `final` or `static`.

The return type must be the entity bean's primary key type.

If the `ejbCreate<METHOD>` method corresponds to a `create<METHOD>` on the entity bean's remote home interface, the method arguments and return value types must be legal types for RMI-IIOP.

The `throws` clause must define the `javax.ejb.CreateException`. The `throws` clause may define arbitrary application specific exceptions.

Compatibility Note: EJB 1.0 allowed the `ejbCreate` method to throw the `java.rmi.RemoteException` to indicate a non-application exception. This practice was deprecated in EJB 1.1—an EJB 1.1 or EJB 2.0 or later compliant enterprise bean should throw the `javax.ejb.EJBException` or another `java.lang.RuntimeException` to indicate non-application exceptions to the container (see Section 14.2.2). The `ejbCreate` method of an entity bean with `cmp-version 2.x` must not throw the `java.rmi.RemoteException`.

8.6.5 `ejbPostCreate<METHOD>` Methods

For each `ejbCreate<METHOD>` method, the entity bean class must define a matching `ejbPostCreate<METHOD>` method, using the following rules:

The method name must have `ejbPostCreate` as its prefix.

The method must be declared as `public`.

The method must not be declared as `final` or `static`.

The return type must be `void`.

The method arguments must be the same as the arguments of the matching `ejbCreate<METHOD>` method.

The `throws` clause may define arbitrary application specific exceptions, including the `javax.ejb.CreateException`.

Compatibility Note: EJB 1.0 allowed the `ejbPostCreate` method to throw the `java.rmi.RemoteException` to indicate a non-application exception. This practice was deprecated in EJB 1.1—an EJB 1.1 or EJB 2.0 or later compliant enterprise bean should throw the `javax.ejb.EJBException` or another `java.lang.RuntimeException` to indicate non-application exceptions to the container (see Section 14.2.2). The `ejbPostCreate` method of an entity bean with `cmp-version 2.x` must not throw the `java.rmi.RemoteException`.

8.6.6 ejbHome<METHOD> Methods

The entity bean class may define zero or more home methods whose signatures must follow the following rules:

An `ejbHome<METHOD>` method must exist for every home `<METHOD>` method on the entity bean's remote home or local home interface. The method name must have `ejbHome` as its prefix followed by the name of the `<METHOD>` method in which the first character has been uppercased.

The method must be declared as `public`.

The method must not be declared as `static`.

If the `ejbHome<METHOD>` method corresponds to a home `<METHOD>` on the entity bean's remote home interface, the method argument and return value types must be legal types for RMI-IIOP.

The `throws` clause may define arbitrary application specific exceptions. The `throws` clause must not throw the `java.rmi.RemoteException`.

8.6.7 ejbSelect<METHOD> Methods

The entity bean class may define one or more select methods whose signatures must follow the following rules:

The method name must have `ejbSelect` as its prefix.

The method must be declared as `public`.

The method must be declared as `abstract`.

The `throws` clause must define the `javax.ejb.FinderException`. The `throws` clause may define arbitrary application specific exceptions.

8.6.8 Business Methods

The entity bean class may define zero or more business methods whose signatures must follow these rules:

The method names can be arbitrary, but they must not start with 'ejb' to avoid conflicts with the callback methods used by the EJB architecture.

The business method must be declared as `public`.

The method must not be declared as `final` or `static`.

If the business method corresponds to a method of the entity bean's remote interface, the method argument and return value types must be legal types for RMI-IIOP.

The `throws` clause may define arbitrary application specific exceptions.

Compatibility Note: EJB 1.0 allowed the business methods to throw the `java.rmi.RemoteException` to indicate a non-application exception. This practice was deprecated in EJB 1.1—an EJB 1.1 or EJB 2.0 or later compliant enterprise bean should throw the `javax.ejb.EJBException` or another `java.lang.RuntimeException` to indicate non-application exceptions to the container (see Section 14.2.2). The business methods of an entity bean with `cmp-version 2.x` must not throw the `java.rmi.RemoteException`.

8.6.9 Entity Bean's Remote Interface

The following are the requirements for the entity bean's remote interface:

The interface must extend the `javax.ejb.EJBObject` interface.

The methods defined in the remote interface must follow the rules for RMI-IIOP. This means that their argument and return value types must be valid types for RMI-IIOP, and their `throws` clauses must include the `java.rmi.RemoteException`.

The remote interface is allowed to have superinterfaces. Use of interface inheritance is subject to the RMI-IIOP rules for the definition of remote interfaces.

For each method defined in the remote interface, there must be a matching method in the entity bean's class. The matching method must have:

- The same name.
- The same number and types of its arguments, and the same return type.
- All the exceptions defined in the `throws` clause of the matching method of the enterprise Bean class must be defined in the `throws` clause of the method of the remote interface.

The remote interface methods must not expose local interface types, local home interface types, timer handles, or the managed collection classes that are used for entity beans with container-managed persistence as arguments or results.

8.6.10 Entity Bean's Remote Home Interface

The following are the requirements for the entity bean's home interface:

The interface must extend the `javax.ejb.EJBHome` interface.

The methods defined in this interface must follow the rules for RMI-IIOP. This means that their argument and return types must be of valid types for RMI-IIOP, and their `throws` clauses must include the `java.rmi.RemoteException`.

The remote home interface is allowed to have superinterfaces. Use of interface inheritance is subject to the RMI-IIOP rules for the definition of remote interfaces.

Each method defined in the remote home interface must be one of the following:

- A create method.
- A finder method.
- A home method.

Each create method must be named “create<METHOD>”, e.g. createLargeAccounts. Each create method name must match one of the `ejbCreate<METHOD>` methods defined in the enterprise bean class. The matching `ejbCreate<METHOD>` method must have the same number and types of its arguments. (Note that the return type is different.)

The return type for a `create<METHOD>` method must be the entity bean’s remote interface type.

All the exceptions defined in the `throws` clause of the matching `ejbCreate<METHOD>` and `ejbPostCreate<METHOD>` methods of the enterprise bean class must be included in the `throws` clause of the matching create method of the home interface (i.e., the set of exceptions defined for the create method must be a superset of the union of exceptions defined for the `ejbCreate<METHOD>` and `ejbPostCreate<METHOD>` methods).

The `throws` clause of a `create<METHOD>` method must include the `javax.ejb.CreateException`.

Each finder method must be named “find<METHOD>” (e.g. findLargeAccounts).

The return type for a `find<METHOD>` method must be the entity bean’s remote interface type (for a single-object finder), or a collection thereof (for a multi-object finder).

The remote home interface must always include the `findByPrimaryKey` method, which is always a single-object finder. The method must declare the primary key class as the method argument.

The `throws` clause of a finder method must include the `javax.ejb.FinderException`.

Home methods can have arbitrary names, but they must not start with “create”, “find”, or “remove”. Their argument and return types must be of valid types for RMI-IIOP, and their `throws` clauses must include the `java.rmi.RemoteException`. The matching `ejbHome` method specified in the entity bean class must have the same number and types of arguments and must return the same type as the home method as specified in the remote home interface of the bean.

The remote home interface methods must not expose local interface types, local home interface types, timers or timer handles, or the managed collection classes that are used for entity beans with container-managed persistence as arguments or results.

8.6.11 Entity Bean’s Local Interface

The following are the requirements for the entity bean’s local interface:

The interface must extend the `javax.ejb.EJBLocalObject` interface.

For each method defined in the local interface, there must be a matching method in the entity bean's class. The matching method must have:

- The same name.
- The same number and types of its arguments, and the same return type.
- All the exceptions defined in the `throws` clause of the matching method of the enterprise Bean class must be defined in the `throws` clause of the method of the local interface.

8.6.12 Entity Bean's Local Home Interface

The following are the requirements for the entity bean's local home interface:

The interface must extend the `javax.ejb.EJBLocalHome` interface.

Each method defined in the home interface must be one of the following:

- A create method.
- A finder method.
- A home method.

Each `create` method must be named "`create<METHOD>`", e.g. `createLargeAccounts`. Each `create` method name must match one of the `ejbCreate<METHOD>` methods defined in the enterprise bean class. The matching `ejbCreate<METHOD>` method must have the same number and types of its arguments. (Note that the return type is different.)

The return type for a `create<METHOD>` method on the local home interface must be the entity bean's local interface type.

All the exceptions defined in the `throws` clause of the matching `ejbCreate<METHOD>` and `ejbPostCreate<METHOD>` methods of the enterprise bean class must be included in the `throws` clause of the matching `create` method of the local home interface (i.e., the set of exceptions defined for the `create` method must be a superset of the union of exceptions defined for the `ejbCreate<METHOD>` and `ejbPostCreate<METHOD>` methods).

The `throws` clause of a `create<METHOD>` method must include the `javax.ejb.CreateException`.

Each `finder` method must be named "`find<METHOD>`" (e.g. `findLargeAccounts`).

The return type for a `find<METHOD>` method defined on the local home interface must be the entity bean's local interface type (for a single-object finder), or a collection thereof (for a multi-object finder).

The local home interface must always include the `findByPrimaryKey` method, which is always a single-object finder. The method must declare the primary key class as the method argument.

The `throws` clause of a `finder` method must include the `javax.ejb.FinderException`.

Home methods can have arbitrary names, but they must not start with “create”, “find”, or “remove”. The matching `ejbHome` method specified in the entity bean class must have the same number and types of arguments and must return the same type as the home method as specified in the home interface of the bean. The `throws` clause of a home method defined on the local home interface must not include the `java.rmi.RemoteException`.

8.6.13 Entity Bean’s Primary Key Class

The Bean Provider must specify a primary key class in the deployment descriptor.

The primary key type must be a legal Value Type in RMI-IIOP.

The class must provide suitable implementation of the `hashCode()` and `equals(Object other)` methods to simplify the management of the primary keys by the container.

8.6.14 Entity Bean’s Deployment Descriptor

The Bean Provider must specify the relationships in which the entity beans participate in the `relationships` element.

The Bean Provider must provide unique names to designate entity beans as follows, and as described in Section 8.3.13.

- The Bean Provider must specify unique names for entity beans which are defined in the `ejb-jar` file by using the `ejb-name` element.
- The Bean Provider must specify a unique abstract schema name for an entity bean using the `abstract-schema-name` deployment descriptor element.

The Bean Provider must define a query for each `finder` or `select` method except `findByPrimaryKey(key)`. Typically this will be provided as the content of the `ejb-ql` element contained in the `query` element for the entity bean. The syntax of EJB QL is defined in Chapter 9.

Since EJB QL query strings are embedded in the deployment descriptor, which is an XML document, it may be necessary to encode the following characters in the query string: “>”, “<”.

8.7 The Responsibilities of the Container Provider

This section describes the responsibilities of the Container Provider to support entity beans. The Container Provider is responsible for providing the deployment tools, and for managing the entity beans at runtime, including their persistent state and relationships.

Because the EJB specification does not define the API between deployment tools and the container, we assume that the deployment tools described in this section are provided by the Container Provider. Alternatively, the deployment tools may be provided by a different vendor who uses the container vendor's specific API.

8.7.1 Generation of Implementation Classes

The deployment tools provided by the Container Provider are responsible for the generation of additional classes when the entity bean is deployed. The tools obtain the information that they need for generation of the additional classes by introspecting the classes and interfaces provided by the Bean Provider and by examining the entity bean's deployment descriptor.

The deployment tools must generate the following classes:

- A class that implements the entity bean's remote home interface (i.e., the entity EJBHome class).
- A class that implements the entity bean's remote interface (i.e., the entity EJBObject class).
- A class that implements the entity bean's local home interface (i.e., the entity EJBLocalHome class).
- A class that implements the entity bean's local interface (i.e., the EJBLocalObject class).
- A class that implements the entity bean class (i.e., a concrete class corresponding to the abstract entity bean class that was provided by the Bean Provider).

The deployment tools may also generate a class that mixes some container-specific code with the entity bean class. The code may, for example, help the container to manage the entity bean instances at runtime. Tools can use subclassing, delegation, and code generation.

The deployment tools may also allow generation of additional code that wraps the business methods and that is used to customize the business logic for an existing operational environment. For example, a wrapper for a `debit` function on the `Account` bean may check that the debited amount does not exceed a certain limit, or perform security checking that is specific to the operational environment.

8.7.2 Enterprise Bean Class

The following are the requirements for a concrete entity bean class:

The class must extend the abstract entity bean class provided by the Bean Provider.

The class must be defined as `public` and must not be `abstract`.

The class must define a public constructor that takes no arguments.

The class must implement the `get` and `set` accessor methods of the bean's abstract persistence schema.

The class must not define the `finalize` method.

The entity bean class must implement the `ejbFind<METHOD>` methods.

The entity bean class must implement the `ejbSelect<METHOD>` methods.

The entity bean class is allowed to implement other methods in addition to the methods required by the EJB specification.

8.7.3 `ejbFind<METHOD>` Methods

For each `find<METHOD>` method in the remote home interface or local home interface of the entity bean, there must be a corresponding `ejbFind<METHOD>` method with the same argument types in the concrete entity bean class.

The method name must have `ejbFind` as its prefix.

The method must be declared as `public`.

If the `ejbFind<METHOD>` method corresponds to a `find<METHOD>` on the entity bean's remote home interface, the method argument and return value types must be legal types for RMI-IIOP.

The return type of an `ejbFind<METHOD>` method must be the entity bean's primary key type, or a collection of primary keys.

The `throws` clause must define the `javax.ejb.FinderException`. The `throws` clause may define arbitrary application specific exceptions.

Every finder method except `ejbFindByPrimaryKey(key)` is specified in the `query` deployment descriptor element for the entity. The container must use the EJB QL query string that is the content of the `ejb-ql` element or the descriptive query specification contained in the `description` element as the definition of the query of the corresponding `ejbFind<METHOD>` method.

8.7.4 `ejbSelect<METHOD>` Methods

For each `ejbSelect<METHOD>` method in the abstract entity bean class, there must be a method with the same argument and result types in the concrete entity bean class.

Every select method is specified in a `query` deployment descriptor element for the entity. The container must use the EJB QL query string that is the content of the `ejb-ql` element or the descriptive query specification that is contained in the `description` element as the definition of the query of the corresponding `ejbSelect<METHOD>` method.

The container must use the contents of the `query` element, the corresponding EJB QL string and the type of the values selected as specified by the `SELECT` clause to determine the type of the values returned by a select method.

The container must ensure that there are no duplicates returned by a select method if the return type is `java.util.Set`.

8.7.5 Entity EJBHome Class

The entity EJBHome class, which is generated by deployment tools, implements the entity bean's remote home interface. This class implements the methods of the `javax.ejb.EJBHome` interface, and the type-specific `create` and `finder` methods specific to the entity bean.

The implementation of each `create<METHOD>` method invokes a matching `ejbCreate<METHOD>` method, followed by the matching `ejbPostCreate<METHOD>` method, passing the `create<METHOD>` parameters to these matching methods.

The implementation of the `remove` methods defined in the `javax.ejb.EJBHome` interface must activate an instance (if an instance is not already in the ready state) and invoke the `ejbRemove` method on the instance.

The implementation of each `find<METHOD>` method invokes a matching `ejbFind<METHOD>` method. The implementation of the `find<METHOD>` method must create an entity object reference for the primary key returned from the `ejbFind<METHOD>` and return the entity object reference to the client. If the `ejbFind<METHOD>` method returns a collection of primary keys, the implementation of the `find<METHOD>` method must create a collection of entity object references for the primary keys and return the collection to the client.

The implementation of each `<METHOD>` home method invokes a matching `ejbHome<METHOD>` method (in which the first character of `<METHOD>` is uppercased in the name of the `ejbHome<METHOD>` method), passing the parameters of the `<METHOD>` method to the matching `ejbHome<METHOD>` method.

8.7.6 Entity EJBOBJECT Class

The entity EJBOBJECT class, which is generated by deployment tools, implements the entity bean's remote interface. It implements the methods of the `javax.ejb.EJBOBJECT` interface and the remote business methods specific to the entity bean.

The implementation of the `remove` method (defined in the `javax.ejb.EJBOBJECT` interface) must activate an instance (if an instance is not already in the ready state) and invoke the `ejbRemove` method on the instance.

The implementation of each remote business method must activate an instance (if an instance is not already in the ready state) and invoke the matching business method on the instance.

8.7.7 Entity EJBLocalHome Class

The entity EJBLocalHome class, which is generated by deployment tools, implements the entity bean's local home interface. This class implements the methods of the `javax.ejb.EJBLocalHome` interface, and the type-specific `create` and `finder` methods specific to the entity bean.

The implementation of each `create<METHOD>` method invokes a matching `ejbCreate<METHOD>` method, followed by the matching `ejbPostCreate<METHOD>` method, passing the `create<METHOD>` parameters to these matching methods.

The implementation of the `remove` method defined in the `javax.ejb.EJBLocalHome` interface must activate an instance (if an instance is not already in the ready state) and invoke the `ejbRemove` method on the instance.

The implementation of each `find<METHOD>` method invokes a matching `ejbFind<METHOD>` method. The implementation of the `find<METHOD>` method must create a local entity object reference for the primary key returned from the `ejbFind<METHOD>` and return the local entity object reference to the local client. If the `ejbFind<METHOD>` method returns a collection of primary keys, the implementation of the `find<METHOD>` method must create a collection of local entity object references for the primary keys and return the collection to the local client.

The implementation of each `<METHOD>` home method invokes a matching `ejbHome<METHOD>` method (in which the first character of `<METHOD>` is uppercased in the name of the `ejbHome<METHOD>` method), passing the parameters of the `<METHOD>` method to the matching `ejbHome<METHOD>` method.

8.7.8 Entity EJBLocalObject Class

The entity `EJBLocalObject` class, which is generated by deployment tools, implements the entity bean's local interface. It implements the methods of the `javax.ejb.EJBLocalObject` interface and the local business methods specific to the entity bean.

The implementation of the `remove` method (defined in the `javax.ejb.EJBLocalObject` interface) must activate an instance (if an instance is not already in the ready state) and invoke the `ejbRemove` method on the instance.

The implementation of each local business method must activate an instance (if an instance is not already in the ready state) and invoke the matching business method on the instance.

8.7.9 Handle Class

The deployment tools are responsible for implementing the handle class for the entity bean. The handle class must be serializable by the Java Serialization protocol.

As the handle class is not entity bean specific, the container may, but is not required to, use a single class for all deployed entity beans.

8.7.10 Home Handle Class

The deployment tools responsible for implementing the home handle class for the entity bean. The handle class must be serializable by the Java Serialization protocol.

Because the home handle class is not entity bean specific, the container may, but is not required to, use a single class for the home handles of all deployed entity beans.

8.7.11 Metadata Class

The deployment tools are responsible for implementing the class that provides metadata information to the remote client view contract. The class must be a valid RMI-IIOP Value Type, and must implement the `javax.ejb.EJBMetaData` interface.

Because the metadata class is not entity bean specific, the container may, but is not required to, use a single class for all deployed enterprise beans.

8.7.12 Instance's Re-entrance

The container runtime must enforce the rules defined in Section 8.5.13.

8.7.13 Transaction Scoping, Security, Exceptions

The container runtime must follow the rules on transaction scoping, security checking, and exception handling described in Chapters 13, 17, and 14.

8.7.14 Implementation of Object References

The container should implement the distribution protocol between the remote client and the container such that the object references of the remote home and remote interfaces used by entity bean clients are usable for a long period of time. Ideally, a remote client should be able to use an object reference across a server crash and restart. An object reference should become invalid only when the entity object has been removed, or after a reconfiguration of the server environment (for example, when the entity bean is moved to a different EJB server or container).

The motivation for this is to simplify the programming model for the entity bean client. While the client code needs to have a recovery handler for the system exceptions thrown from the individual method invocations on the remote home and remote interface, the client should not be forced to re-obtain the object references.

8.7.15 EntityContext

The container must implement the `EntityContext.getEJBObject` method such that the bean instance can use the Java language cast to convert the returned value to the entity bean's remote interface type. Specifically, the bean instance does not have to use the `PortableRemoteObject.narrow` method for the type conversion.

8.8 Primary Keys

The container must be able to manipulate the primary key type of an entity bean. Therefore, the primary key type for an entity bean with container-managed persistence must follow the rules in this subsection, in addition to those specified in Subsection 8.6.13.

There are two ways to specify a primary key class for an entity bean with container-managed persistence:

- Primary key that maps to a single field in the entity bean class.
- Primary key that maps to multiple fields in the entity bean class.

The second method is necessary for implementing compound keys, and the first method is convenient for single-field keys. Without the first method, simple types such as `String` would have to be wrapped in a user-defined class.

8.8.1 Primary Key That Maps to a Single Field in the Entity Bean Class

The Bean Provider uses the `primkey-field` element of the deployment descriptor to specify the container-managed field of the entity bean class that contains the primary key. The field's type must be the primary key type.

8.8.2 Primary Key That Maps to Multiple Fields in the Entity Bean Class

The primary key class must be `public`, and must have a `public` constructor with no parameters.

All fields in the primary key class must be declared as `public`.

The names of the fields in the primary key class must be a subset of the names of the container-managed fields. (This allows the container to extract the primary key fields from an instance's container-managed fields, and vice versa.)

8.8.3 Special Case: Unknown Primary Key Class

In special situations, the entity Bean Provider may choose not to specify the primary key class or the primary key fields for an entity bean with container-managed persistence. This case usually happens when the entity bean does not have a natural primary key, and/or the Bean Provider wants to allow the Deployer using the Container Provider's tools to select the primary key fields at deployment time. The entity bean's primary key type will usually be derived from the primary key type used by the underlying database system that stores the entity objects. The primary key used by the database system may not be known to the Bean Provider.

In this special case, the type of the argument of the `findByPrimaryKey` method must be declared as `java.lang.Object`. The Bean Provider must specify the primary key class in the deployment descriptor as of the type `java.lang.Object`.

When defining the primary key for the enterprise bean, the Deployer using the Container Provider's tools will typically add additional container-managed fields to the concrete subclass of the entity bean class (this typically happens for entity beans that do not have a natural primary key, and the primary keys are system-generated by the underlying database system that stores the entity objects). In this case, the container must generate the primary key value when the entity bean instance is created (and before `ejbPostCreate` is invoked on the instance.)

The primary key class is specified at deployment time in the situations when the Bean Provider develops an entity bean that is intended to be used with multiple back-ends that provide persistence, and when these multiple back-ends require different primary key structures.

Use of entity beans with a deferred primary key type specification limits the client application programming model, because the clients written prior to deployment of the entity bean may not use, in general, the methods that rely on the knowledge of the primary key type.

The implementation of the enterprise bean class methods must be done carefully. For example, the methods should not depend on the type of the object returned from `EntityContext.getPrimaryKey`, because the return type is determined by the Deployer after the EJB class has been written.

Chapter 9

EJB QL: EJB 2.1 Query Language for Container-Managed Persistence Query Methods

The Enterprise JavaBeans query language, EJB QL, is used to define queries for entity beans with container-managed persistence. EJB QL enables the Bean Provider to specify the semantics of query methods in a portable way.

This chapter provides the complete definition of EJB QL that is required to be supported for use with EJB 2.1 entity beans with container managed persistence. Implementations of this specification are permitted, but not required, to provide the extensions to EJB QL defined by the Java Persistence query language [2] for use with finder and select methods. Applications that make use of such extensions in finder and select methods will not be portable.

The Enterprise JavaBeans query language, EJB QL, has been proposed for future removal. See Section 2.7 for more details.

9.1 Overview

EJB QL is a query specification language for the finder and select methods of entity beans with container-managed persistence. EJB QL can be compiled to a target language, such as SQL, of a database or other persistent store. This allows the execution of queries to be shifted to the native language facilities provided by the persistent store, instead of requiring queries to be executed on the runtime representation of the entity beans' state. As a result, query methods can be optimizable as well as portable.

The Enterprise JavaBeans query language uses the abstract persistence schemas of entity beans, including their relationships, for its data model. It defines operators and expressions based on this data model.

The Bean Provider uses EJB QL to write queries based on the abstract persistence schemas and the relationships defined in the deployment descriptor. EJB QL depends on navigation and selection based on the cmp-fields and cmr-fields of the related entity beans. The Bean Provider can navigate from an entity bean to other entity beans by using the names of cmr-fields in EJB QL queries.

EJB QL allows the Bean Provider to use the abstract schema types of entity beans in a query if the abstract persistence schemas of the beans are defined in the same deployment descriptor as the query.

It is possible to parse and validate EJB QL queries before entity beans are deployed because EJB QL is based on the abstract schema types of entity beans.

EJB QL queries can be used in two different ways:

- as queries for selecting entity objects through finder methods defined in the home interface. Finder methods allow the results of an EJB QL query to be used by the clients of the entity bean.
- as queries for selecting entity objects or other values derived from an entity bean's abstract schema type through select methods defined on the entity bean class. Select methods allow the Bean Provider to use EJB QL to find objects or values related to the state of an entity bean without directly exposing the results to the client.

9.2 EJB QL Definition

EJB QL uses a SQL-like syntax to select objects or values based on the abstract schema types and relationships of entity beans. The path expressions of EJB QL allow the Bean Provider to navigate over relationships defined by the cmr-fields of the abstract schema types of entity beans.

This chapter provides the full definition of the language.

An EJB QL query is a string which consists of the following clauses:

- a SELECT clause, which determines the type of the objects or values to be selected.
- a FROM clause, which provides declarations that designate the domain to which the expressions specified in the SELECT clause and WHERE clause of the query apply.
- an optional WHERE clause, which may be used to restrict the results that are returned by the query.
- an optional ORDER BY clause, which may be used to order the results that are returned by the query.

In BNF syntax, an EJB QL query is defined as:

```
EJB QL ::= select_clause from_clause [where_clause] [orderby_clause]
```

An EJB QL query must always have a SELECT and a FROM clause. The square brackets [] indicate that the WHERE and ORDER BY clauses are optional.

An EJB QL query may have parameters that correspond to the parameters of the finder or select method for which it is defined.

An EJB QL query is statically defined in the `ejb-ql` deployment descriptor element.

9.2.1 Abstract Schema Types and Query Domains

EJB QL is a typed language whose design is based on the type model of EJB 2.0 container-managed persistence. Every expression in EJB QL has a type. The type of the expression is derived from the structure of the expression; the abstract schema types of the identification variable declarations; the types to which the `cmp-fields` and `cmr-fields` evaluate; and the types of literals. The allowable types in EJB QL are the abstract schema types of entity beans and `cmp-fields`.

The abstract schema type of an entity bean is derived from its entity bean class and the information provided in the deployment descriptor. There is a one-to-one mapping between entity bean abstract schema types and entity bean homes. Abstract schema names, as specified by the `abstract-schema-name` elements in the deployment descriptor, are used to denote entity bean abstract schema types in EJB QL.

Informally, the abstract schema type of an entity bean can be characterized as follows:

- *For every get accessor method of the entity bean class that corresponds to a `cmp-field` element in the deployment descriptor, there is a field (“`cmp-field`”) whose abstract schema type corresponds to the result type of the accessor method.*
- *For every get accessor method of the entity bean that corresponds to a `cmr-field` element in the deployment descriptor, there is a field (“`cmr-field`”) whose type is the abstract schema type of the entity bean denoted by the `ejb-name` element contained in the corresponding `ejb-relationship-role` element (or, if the role has a multiplicity of `Many`, a collection of such).*

Abstract schema types are specific to the EJB QL data model. The container is not required to implement or otherwise materialize an abstract schema type.

The domain of an EJB QL query consists of the abstract schema types of all entity beans with container-managed persistence that are defined in the same deployment descriptor.

The Bean Provider creates an ejb-jar file which contains a deployment descriptor describing several entity beans and their relationships. EJB QL assumes that a single deployment descriptor in an ejb-jar file constitutes a nondecomposable unit for the container responsible for implementing the abstract persistence schemas of the entity beans and the relationships defined in the deployment descriptor and the ejb-jar file. Queries can be written by utilizing navigation over the cmr-fields of related beans supplied in the same ejb-jar by the Bean Provider because they are implemented and managed by the same container.

The domain of a query may be restricted by the *navigability* of the relationships of the entity bean on which it is based. The cmr-fields of an entity bean's abstract schema type determine navigability. Using the cmr-fields and their values, a query can select related entity beans and use their abstract schema types in the query.

9.2.2 Query Methods

EJB QL is used for two types of query methods:

- **Finder methods**—Finder methods are defined in the home interface(s) of an entity bean and return entity objects or local entity objects. A finder method that is defined on the remote home interface must return either an EJBObject or a collection of EJBObjects; a finder method that is defined on the local home interface must return either an EJBLocalObject or a collection of EJBLocalObjects. The result type of a finder method defined on the remote home interface of an entity bean is the entity bean's remote interface (or a collection of objects implementing the entity bean's remote interface). The result type of a finder method defined on the local home interface of an entity bean is the entity bean's local interface (or a collection of objects implementing the entity bean's local interface).
- **Select methods**—Select methods are a special type of query method not directly exposed through the client view. The Bean Provider typically uses select methods to select the persistent state of an entity object or to select entities that are related to the entity bean for which the query is defined. The result type of a select method can be an EJBLocalObject (or a collection of EJBLocalObjects), an EJBObject (or a collection of EJBObjects), a cmp-field value (or a collection of such), or the result of an aggregate function.

9.2.3 Naming

Entity beans are designated in EJB QL query strings by their abstract schema names. The Bean Provider assigns unique abstract schema names to entity beans as part of the development process so that they can be used within queries. These unique names are scoped within the deployment descriptor file.

9.2.4 Examples

The following convention refers to the names used for entity beans in subsequent examples: An entity bean as a whole is designated by `<name>EJB`, and its entity bean class and abstract schema type are designated by `<name>`, following the convention used to name the local interface of an entity bean.

The first example assumes that the Bean Provider provides several entity beans, `OrderEJB`, `ProductEJB`, `LineItemEJB`, `ShippingAddressEJB`, and `BillingAddressEJB`. The abstract schema types for these entity beans are `Order`, `Product`, `LineItem`, `ShippingAddress`, and `BillingAddress` respectively. These beans are logically in the same `ejb-jar` file, as shown in Figure 18. Only two of the entity beans, `OrderEJB` and `ProductEJB`, have remote interfaces and remote home interfaces.

Figure 18 Several Entity Beans with Abstract Persistence Schemas Defined in the Same Ejb-jar File.

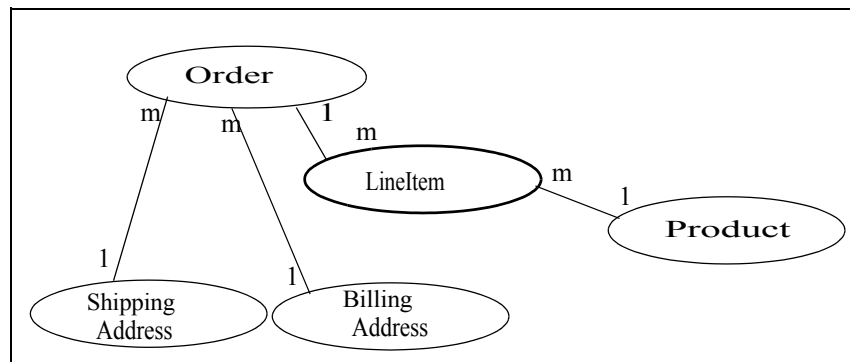

The entity beans `ShippingAddress` and `BillingAddress` each have one-to-many relationships with `Order`. There is also a one-to-many relationship between `Order` and `LineItem`. The entity bean `LineItem` is related to `Product` in a many-to-one relationship.

EJB QL allows the Bean Provider to specify finder queries for `OrderEJB` by navigating over the `cmr`-fields and `cmp`-fields defined by `Order` and `LineItem`. A finder method query to find all orders with pending line items might be written as follows:

```

SELECT DISTINCT OBJECT(o)
FROM Order AS o, IN(o.lineItems) AS l
WHERE l.shipped = FALSE
  
```

This query navigates over the `cmr`-field `lineItems` of the abstract schema type `Order` to find line items, and uses the `cmp`-field `shipped` of `LineItem` to select those orders that have at least one line item that has not yet shipped. (Note that this query does not select orders that have no line items.)

Although predefined reserved identifiers, such as `DISTINCT`, `OBJECT`, `FROM`, `AS`, `IN`, `WHERE`, and `FALSE` appear in upper case in this example, predefined reserved identifiers are case insensitive.

The SELECT clause of this example designates the return type of this query to be of type `Order`. If this query is defined for a finder method on the entity bean's remote home interface, the finder method will return objects of the entity bean's remote interface type corresponding to the abstract schema type instances selected by the query. If this same query is defined for a finder method on the entity bean's local home interface, the finder method will return objects of the entity bean's local interface type corresponding to these same abstract schema type instances. Finder methods must always return `EJBObjects` or `EJBLocalObjects` of the bean type for which the query method is defined.

Because the same deployment descriptor defines the abstract persistence schemas of the related entity beans, the Bean Provider can also specify a query for `OrderEJB` that utilizes the abstract schema type of `ProductEJB`, and hence the `cmp`-fields and `cmr`-fields of both the abstract schema types `Order` and `Product`. For example, if the abstract schema type `Product` has a `cmp`-field named `product_type`, a finder query for `OrderEJB` can be specified using this `cmp`-field. Such a finder query might be: "Find all orders for products with product type *office supplies*". An EJB QL query string for this might be as follows.

```
SELECT DISTINCT OBJECT(o)
FROM Order o, IN(o.lineItems) l
WHERE l.product.product_type = 'office_supplies'
```

Because `Order` is related to `Product` by means of the relationships between `Order` and `LineItem` and between `LineItem` and `Product`, navigation using the `cmr`-fields `lineItems` and `product` is needed to express the query. This query is specified by using the `abstract-schema-name` for `OrderEJB`, namely `Order`, which designates the abstract schema type over which the query ranges. The basis for the navigation is provided by the `cmr`-fields `lineItems` and `product` of the abstract schema types `Order` and `LineItem` respectively.

9.2.5 The FROM Clause and Navigational Declarations

The FROM clause of an EJB QL query defines the domain of the query by declaring identification variables. The domain of the query may be constrained by path expressions.

Identification variables designate instances of a particular entity bean abstract schema type. The FROM clause can contain multiple identification variable declarations separated by a comma (,).

```
from_clause ::= FROM identification_variable_declaration
                [, identification_variable_declaration]*
identification_variable_declaration ::= collection_member_declaration |
                range_variable_declaration
collection_member_declaration ::= IN (collection_valued_path_expression) [AS] identifier
range_variable_declaration ::= abstract_schema_name [AS] identifier
```

The following subsections discuss the constructs used in the FROM clause.

9.2.5.1 Identifiers

An identifier is a character sequence of unlimited length. The character sequence must begin with a Java identifier start character, and all other characters must be Java identifier part characters. An identifier start character is any character for which the method `Character.isJavaIdentifierStart` returns true. This includes the underscore (`_`) character and the dollar sign (`$`) character. An identifier part character is any character for which the method `Character.isJavaIdentifierPart` returns true. The question mark (`?`) character is reserved for use by EJB QL.

The following are the reserved identifiers in EJB QL: *SELECT, FROM, WHERE, DISTINCT, OBJECT, NULL, TRUE, FALSE, NOT, AND, OR, BETWEEN, LIKE, IN, AS, UNKNOWN*^[42], *EMPTY, MEMBER, OF, IS, AVG, MAX, MIN, SUM, COUNT, ORDER, BY, ASC, DESC, MOD.*

Reserved identifiers are case insensitive. Reserved identifiers must not be used as identification variables.

It is recommended that the Bean Provider not use other SQL reserved words as identification variables in EJB QL queries because they may be used as EJB QL reserved identifiers in future versions of the EJB specification.

9.2.5.2 Identification Variables

An identification variable is a valid identifier declared in the FROM clause of an EJB QL query. An identification variable may be declared using the special operators IN and, optionally, AS.

All identification variables must be declared in the FROM clause. Identification variables cannot be declared in other clauses.

An identification variable must not be a reserved identifier or have the same name as any of the following:

- abstract-schema-name
- ejb-name^[43]

Identification variables are case insensitive.

An identification variable evaluates to a value of the type of the expression used in declaring the variable. For example, consider the previous finder query for `OrderEJB`:

```
SELECT DISTINCT OBJECT(o)
FROM Order o, IN(o.lineItems) l
WHERE l.product.product_type = 'office_supplies'
```

[42] Not currently used in EJB QL; reserved for future use.

[43] Use of ejb-names in EJB QL is reserved for future use.

In the FROM clause declaration `IN(o.lineItems) l`, the identification variable `l` evaluates to any `LineItem` value directly reachable from `Order`. The cmr-field `lineItems` is a collection of instances of the abstract schema type `LineItem` and the identification variable `l` refers to an element of this collection. The type of `l` is the abstract schema type of `LineItem`.

An identification variable ranges over the abstract schema type of an entity bean. An identification variable designates an instance of an entity bean abstract schema type or an element of a collection of entity bean abstract schema types instances. Identification variables are existentially quantified in an EJB QL query.

An identification variable always designates a reference to a single value. It is declared in one of two ways; as a range variable or as a collection member identification variable:

- A range variable is declared using the abstract schema name of an entity bean.
- A collection member identification variable is declared using a collection-valued path expression.

The identification variable declarations are evaluated from left to right in the FROM clause. A collection member identification variable declaration can use the result of a preceding identification variable declaration of the query string.

9.2.5.3 Range Variable Declarations

The EJB QL syntax for declaring an identification variable as a range variable is similar to that of SQL; optionally, it uses the `AS` keyword.

range_variable_declaration ::= abstract_schema_name [AS] identifier

Objects or values that are related to an entity bean are typically obtained by navigation using path expressions. However, navigation does not reach all objects. Range variable declarations allow the Bean Provider to designate a “root” for objects which may not be reachable by navigation.

If the Bean Provider wants to select values by comparing more than one instance of an entity bean abstract schema type, more than one identification variable ranging over the abstract schema type is needed in the FROM clause.

The following finder method query returns orders whose quantity is greater than the order quantity for John Smith. This example illustrates the use of two different identification variables in the FROM clause, both of the abstract schema type `Order`. The SELECT clause of this query determines that it is the orders with quantities larger than John Smith’s that are returned.

```
SELECT DISTINCT OBJECT(o1)
FROM Order o1, Order o2
WHERE o1.quantity > o2.quantity AND
      o2.customer.lastname = 'Smith' AND
      o2.customer.firstname = 'John'
```

9.2.5.4 Collection Member Declarations

An identification variable declared by a *collection_member_declaration* ranges over values of a collection obtained by navigation using a path expression. Such a path expression represents a navigation involving the cmr-fields of an entity bean abstract schema type. Because a path expression can be based on another path expression, the navigation can use the cmr-fields of related entity beans. Path expressions are discussed in Section 9.2.5.6.

An identification variable of a collection member declaration is declared using a special operator, the reserved identifier `IN`. The argument to the `IN` operator is a collection-valued path expression. The path expression evaluates to a collection type specified as a result of navigation to a collection-valued cmr-field of an entity bean abstract schema type.

The syntax for declaring a collection member identification variable is as follows:

```
collection_member_declaration ::= IN (collection_valued_path_expression) [AS] identifier
```

For example, the `FROM` clause for a query defined for `OrderEJB` might contain the following collection member declaration:

```
IN(o.lineItems) l
```

In this example, `lineItems` is the name of a cmr-field whose value is a collection of instances of the abstract schema type `LineItem` of the `LineItemEJB` entity bean. The identification variable `l` designates a member of this collection, a *single* `LineItem` abstract schema type instance. In this example, `o` is an identification variable of the abstract schema type `Order`.

9.2.5.5 Example

The following `FROM` clause contains two identification variable declaration clauses. The identification variable declared in the first clause is used in the second clause. The clauses declare the variables `o` and `l` respectively. The range variable declaration `Order AS o` designates the identification variable `o` as a range variable whose type is the abstract schema type, `Order`. The identification variable `l` has the abstract schema type `LineItem`. Because the clauses are evaluated from left to right, the identification variable `l` can utilize the results of the navigation on `o`.

```
FROM Order AS o, IN(o.lineItems) l
```

9.2.5.6 Path Expressions

An identification variable followed by the navigation operator (`.`) and a cmp-field or cmr-field is a path expression. The type of the path expression is the type computed as the result of navigation; that is, the type of the cmp-field or cmr-field to which the expression navigates.

Depending on navigability, a path expression that leads to a cmr-field may be further composed. Path expressions can be composed from other path expressions if the original path expression evaluates to a single-valued type (not a collection) corresponding to a cmr-field. A path expression that ends in a cmp-field is terminal and cannot be further composed.

Path expression navigability is composed using “inner join” semantics. That is, if the value of a non-terminal cmr-field in the path expression is null, the path is considered to have no value, and does not participate in the determination of the result.

The syntax for single-valued path expressions and collection valued path expressions is as follows:

```

cmp_path_expression ::=
    {identification_variable | single_valued_cmr_path_expression}.cmp_field
single_valued_cmr_path_expression ::=
    identification_variable.[single_valued_cmr_field .]*single_valued_cmr_field
single_valued_path_expression ::=
    cmp_path_expression | single_valued_cmr_path_expression
collection_valued_path_expression ::=
    identification_variable.[single_valued_cmr_field .]*collection_valued_cmr_field

```

A *single_valued_cmr_field* is designated by the name of a cmr-field in a one-to-one or many-to-one relationship. The type of a *single_valued_cmr_path_expression* is the abstract schema type of the related entity bean.

A *collection_valued_cmr_field* is designated by the name of a cmr-field in a one-to-many or a many-to-many relationship. The type of a *collection_valued_cmr_field* is a collection of values of the abstract schema type of the related entity bean.

Navigation to a related entity bean results in a value of the related entity bean’s abstract schema type.

The evaluation of a path expression terminating in a cmr-field results in the abstract schema type corresponding to the Java type designated by the cmr-field.

It is syntactically illegal to compose a path expression from a path expression that evaluates to a collection. For example, if *o* designates *Order*, the path expression *o.lineItems.product* is illegal since navigation to *lineItems* results in a collection. This case should produce an error when the EJB QL query string is verified. To handle such a navigation, an identification variable must be declared in the FROM clause to range over the elements of the *lineItems* collection. Another path expression must be used to navigate over each such element in the WHERE clause of the query, as in the following:

```

SELECT OBJECT(o)
FROM Order AS o, IN(o.lineItems) l
WHERE l.product.name = 'widget'

```

9.2.6 WHERE Clause and Conditional Expressions

The WHERE clause of a query consists of a conditional expression used to select objects or values that satisfy the expression. The WHERE clause thus restricts the result of a query.

A WHERE clause is defined as follows:

```

where_clause ::= WHERE conditional_expression

```

The following sections describe the language constructs that can be used in a conditional expression of the WHERE clause.

9.2.6.1 Literals

A string literal is enclosed in single quotes—for example: 'literal'. A string literal that includes a single quote is represented by two single quotes—for example: 'literal''s'. EJB QL string literals, like Java `String` literals, use unicode character encoding.

An exact numeric literal is a numeric value without a decimal point, such as 57, -957, +62. Exact numeric literals support numbers in the range of Java `long`. Exact numeric literals use the Java integer literal syntax.

An approximate numeric literal is a numeric value in scientific notation, such as 7E3, -57.9E2, or a numeric value with a decimal, such as 7., -95.7, +6.2. Approximate numeric literals support numbers in the range of Java `double`. Approximate literals use the Java floating point literal syntax.

The Bean Provider may utilize appropriate suffixes to indicate the specific type of the literal in accordance with the Java Language Specification.

The boolean literals are `TRUE` and `FALSE`.

Although predefined reserved literals appear in upper case, they are case insensitive.

9.2.6.2 Identification Variables

All identification variables used in the WHERE clause of an EJB QL query must be declared in the FROM clause, as described in Section 9.2.5.2.

Identification variables are existentially quantified in the WHERE clause. This means that an identification variable represents a member of a collection or an instance of an entity bean's abstract schema type. An identification variable never designates a collection in its entirety.

9.2.6.3 Path Expressions

It is illegal to use a *collection_valued_path_expression* within a WHERE clause as part of a conditional expression except in an *empty_collection_comparison_expression* or *collection_member_expression*.

9.2.6.4 Input Parameters

The following rules apply to input parameters. Input parameters can only be used in the WHERE clause of a query.

- Input parameters are designated by the question mark (?) prefix followed by an integer. For example: ?1.
- Input parameters are numbered starting from 1.
- The number of distinct input parameters in an EJB QL query must not exceed the number of input parameters for the finder or select method. It is not required that the EJB QL query use all of the input parameters for the finder or select method.
- An input parameter evaluates to the abstract schema type of the corresponding parameter defined in the signature of the finder or select method with which the query is associated. It is the responsibility of the container to map the input parameter to the appropriate abstract schema type value.

Note that if an input parameter value is null, comparison operations or arithmetic operations involving the input parameter will return an unknown value. See Section 9.2.10.

9.2.6.5 Conditional Expression Composition

Conditional expressions are composed of other conditional expressions, comparison operations, logical operations, path expressions that evaluate to boolean values, and boolean literals.

Arithmetic expressions can be used in comparison expressions. Arithmetic expressions are composed of other arithmetic expressions, arithmetic operations, path expressions that evaluate to numeric values, and numeric literals.

Arithmetic operations use numeric promotion.

Standard bracketing () for ordering expression evaluation is supported.

Conditional expressions are defined as follows:

```
conditional_expression ::= conditional_term | conditional_expression OR conditional_term
conditional_term ::= conditional_factor | conditional_term AND conditional_factor
conditional_factor ::= [ NOT ] conditional_primary
conditional_primary ::= simple_cond_expression | (conditional_expression)
simple_cond_expression ::= comparison_expression | between_expression | like_expression |
                        in_expression | null_comparison_expression |
                        empty_collection_comparison_expression |
                        collection_member_expression
```

9.2.6.6 Operators and Operator Precedence

The operators are listed below in order of decreasing precedence.

- Navigation operator (.)
- Arithmetic operators:
 - + , - unary
 - *, / multiplication and division
 - + , - addition and subtraction
- Comparison operators : =, >, >=, <, <=, <> (not equal)
- Logical operators: NOT, AND, OR

The following sections describe other operators used in specific expressions.

9.2.6.7 Between Expressions

The syntax for the use of the comparison operator [NOT] BETWEEN in an conditional expression is as follows:

arithmetic_expression [NOT] BETWEEN *arithmetic-expression* AND *arithmetic-expression*

The BETWEEN expression

x BETWEEN *y* AND *z*

is semantically equivalent to:

y <= *x* AND *x* <= *z*

The rules for unknown and NULL values in comparison operations apply. See Section 9.2.10.

Examples are:

p.age BETWEEN 15 and 19 is equivalent to *p.age* >= 15 AND *p.age* <= 19

p.age NOT BETWEEN 15 and 19 is equivalent to *p.age* < 15 OR *p.age* > 19

9.2.6.8 In Expressions

The syntax for the use of the comparison operator [NOT] IN in a conditional expression is as follows:

cmp_path_expression [NOT] IN ({*literal* | *input_parameter*} [, {*literal* | *input_parameter*}]*)

The *cmp_path_expression* must have a string or numeric value. The literal and/or *input_parameter* values must be *like* the same abstract schema type of the *cmp_path_expression* in type. (See Section 9.2.11).

Examples are:

`o.country IN ('UK', 'US', 'France')` is true for UK and false for Peru, and is equivalent to the expression `(o.country = 'UK') OR (o.country = 'US') OR (o.country = 'France')`.

`o.country NOT IN ('UK', 'US', 'France')` is false for UK and true for Peru, and is equivalent to the expression `NOT ((o.country = 'UK') OR (o.country = 'US') OR (o.country = 'France'))`.

There must be at least one element in the comma separated list that defines the set of values for the IN expression.

If the value of a *cmp_path_expression* in an IN or NOT IN expression is NULL or unknown, the value of the expression is unknown.

9.2.6.9 Like Expressions

The syntax for the use of the comparison operator [NOT] LIKE in a conditional expression is as follows:

cmp_path_expression [NOT] LIKE *pattern_value* [ESCAPE *escape_character*]

The *cmp_path_expression* must have a string value. The *pattern_value* is a string literal or a string-valued input parameter in which an underscore (`_`) stands for any single character, a percent (`%`) character stands for any sequence of characters (including the empty sequence), and all other characters stand for themselves. The optional *escape_character* is a single-character string literal or a character-valued input parameter (i.e., `char` or `Character`) and is used to escape the special meaning of the underscore and percent characters in *pattern_value*.^[44]

Examples are:

- *address.phone* LIKE '12%3' is true for '123' '12993' and false for '1234'
- *asentence.word* LIKE 'l_se' is true for 'lose' and false for 'loose'
- *aword.underscored* LIKE '_%' ESCAPE '\' is true for '_foo' and false for 'bar'
- *address.phone* NOT LIKE '12%3' is false for '123' and '12993' and true for '1234'

If the value of the *cmp_path_expression* or *pattern_value* is NULL or unknown, the value of the LIKE expression is unknown. If the *escape_character* is specified and is NULL, the value of the LIKE expression is unknown.

9.2.6.10 Null Comparison Expressions

The syntax for the use of the comparison operator IS NULL in a conditional expression is as follows:

[44] Refer to [24] for a more precise characterization of these rules.

{single_valued_path_expression | input_parameter} IS [NOT] NULL

A null comparison expression tests whether or not the single-valued path expression or input parameter is a NULL value.

9.2.6.11 Empty Collection Comparison Expressions

The syntax for the use of the comparison operator IS EMPTY in an *empty_collection_comparison_expression* is as follows:

collection_valued_path_expression IS [NOT] EMPTY

This expression tests whether or not the collection designated by the collection-valued path expression is empty (i.e, has no elements).

Note that a collection-valued path expression can only be used in the WHERE clause in an empty collection comparison expression or in a collection member expression.

The collection designated by the collection-valued path expression used in an empty collection comparison expression must not be used in the FROM clause for the declaration of an identification variable. An identification variable declared as a member of a collection implicitly designates the existence of a non-empty relationship; testing whether the same collection is empty is contradictory. Therefore, the following query is invalid.

```
SELECT OBJECT(o)
FROM Order o, IN(o.lineItems) l
WHERE o.lineItems IS EMPTY
```

If the value of the collection-valued path expression in an empty collection comparison expression is unknown, the value of the empty comparison expression is unknown.

9.2.6.12 Collection Member Expressions

The syntax for the use of the comparison operator MEMBER OF^[45] in an *collection_member_expression* is as follows:

{single_valued_cmr_path_expression | identification_variable | input_parameter} [NOT] MEMBER [OF] collection_valued_path_expression

This expression tests whether the designated value is a member of the collection specified by the collection-valued path expression.

Note that a collection-valued path expression can only be used in the WHERE clause in an empty collection comparison expression or in a collection member expression.

[45] The use of the reserved word OF is optional in this expression.

If the collection valued path expression designates an empty collection, the value of the MEMBER OF expression is FALSE and the value of the NOT MEMBER OF expression is TRUE. Otherwise, if the value of the collection-valued path expression or single-valued cmr path expression in the collection member expression is unknown, the value of the collection member expression is unknown.

9.2.6.13 Functional Expressions

EJB QL includes the following built-in functions^[46], which may be used in the WHERE clause of a query.

String Functions:

- `CONCAT(String, String)` returns a `String`
- `SUBSTRING(String, start, length)` returns a `String`
- `LOCATE(String, String [, start])`^[47] returns an `int`
- `LENGTH(String)` returns an `int`

Note that `start` and `length` are integer values. The first position in a string is designated as 1 by these functions.

Arithmetic Functions:

- `ABS(number)` returns a number (`int`, `float`, or `double`) of the same type as the argument to the function
- `SQRT(double)` returns a `double`
- `MOD(int, int)` returns an `int`

Numeric arguments to these functions may correspond to the numeric Java object types as well as the primitive numeric types.

If the value of any argument to a functional expression is null or unknown, the value of the functional expression is unknown.

[46] These functions are a subset of the functions defined for JDBC 2.0 and later drivers, as described in Appendix C of the JDBC 3.0 specification [29].

[47] Containers and databases may not support the use of the optional, third argument of the LOCATE function. Portable applications should therefore avoid use of this argument.

9.2.7 **SELECT Clause**

The SELECT clause denotes the query result. The SELECT clause contains either a single range variable that ranges over an entity bean abstract schema type, a single-valued path expression, or an aggregate select expression. In the case of a finder method, the SELECT clause is restricted to contain either a single range variable or a single-valued path expression that evaluates to the abstract schema type of the entity bean for which the finder method is defined.

The SELECT clause has the following syntax:

```
select_clause ::= SELECT [DISTINCT] {select_expression | OBJECT(identification_variable)}
```

```
select_expression ::= single_valued_path_expression | aggregate_select_expression
```

```
aggregate_select_expression ::=
```

```
  { AVG | MAX | MIN | SUM | COUNT } ([DISTINCT] cmp_path_expression) |  
  COUNT ([DISTINCT] identification_variable | single_valued_cmr_path_expression)
```

All standalone identification variables in the SELECT clause must be qualified by the OBJECT operator. The SELECT clause must not use the OBJECT operator to qualify path expressions.

Note that the SELECT clause must be specified to return a single-valued expression. The query below is therefore not valid:

```
SELECT o.lineItems FROM Order AS o
```

The DISTINCT keyword is used to specify that duplicate values must be eliminated from the query result. If DISTINCT is not specified, duplicate values are not eliminated unless the query is specified for a method whose result type is `java.util.Set`. If a query is specified for a method whose result type is `java.util.Set`, but does not specify DISTINCT, the container must interpret the query as if SELECT DISTINCT had been specified. In general, however, the Bean Provider should specify the DISTINCT keyword when writing queries for methods that return `java.util.Set`.

The SELECT clause determines the type of the values returned by a query. For example, the following query returns a collection of products:

```
SELECT l.product FROM Order AS o, IN(o.lineItems) l
```

It is the responsibility of the container to map the abstract schema types returned by the query to the Java types that are returned by the finder or select method with which the query is associated and to materialize those return types, as described in Section 9.2.9.

9.2.7.1 **Null Values in the Query Result**

If the result of an EJB QL query corresponds to a cmr-field or cmp-field whose value is null, the container must include that null value in the result that is returned by the finder or select method. The Bean Provider can use the IS NOT NULL construct to eliminate such null values from the result set of the query.

If the finder or select method is a single-object finder or select method, and the result set of the query consists of a single null value, the container must return the null value as the result of the method. If the result set of a query for a single-object finder or select method contains more than one value (whether non-null, null, or a combination), the container must throw the `FinderException`.

Note, however, that `cmp-field` types defined in terms of Java numeric primitive types cannot produce NULL values in the query result. An EJB QL query that returns such a `cmp-field` type as a result type must not return a null value. (If the Bean Provider wishes to allow null values for `cmp-fields`, he or she should specify those `cmp-fields` to have the equivalent Java object types instead of primitive types, e.g., `Integer` rather than `int`.)

9.2.7.2 Aggregate Functions in the SELECT Clause

The result of an EJB QL query may be the result of an aggregate function applied to a path expression.

The following aggregate functions can be used in the SELECT clause of an EJB QL query: AVG, COUNT, MAX, MIN, SUM.

For all aggregate functions except COUNT, the path expression that is the argument to the aggregate function must terminate in a `cmp-field`. The path expression argument to COUNT may terminate in either a `cmp-field` or a `cmr-field`, or the argument to COUNT may be an identification variable.

Arguments to the functions SUM and AVG must be numeric. Arguments to the functions MAX and MIN must correspond to orderable `cmp-field` types (i.e., numeric types, string types, character types, or date types).

The argument to an aggregate function may be preceded by the keyword DISTINCT to specify that duplicate values are to be eliminated before the aggregate function is applied.^[48]

Null values are eliminated before the aggregate function is applied, regardless of whether the keyword DISTINCT is specified.

9.2.7.3 Examples

The following example returns all line items related to some order:

```
SELECT OBJECT(l)
FROM Order o, IN(o.lineItems) l
```

The following query returns all line items regardless of whether a line item is related to any order or product:

```
SELECT OBJECT(l)
FROM LineItems AS l
```

[48] It is legal to specify DISTINCT with MAX or MIN, but it does not affect the result.

The following query returns the average order quantity:

```
SELECT AVG(o.quantity)
FROM Order o
```

The following query returns the total cost of the items that John Smith has ordered.

```
SELECT SUM(l.price)
FROM Order o, IN(o.lineItems) l
WHERE o.customer.lastname = 'Smith' AND o.customer.firstname = 'John'
```

The following query returns the number of items in John Smith's entire order.

```
SELECT COUNT(l)
FROM Order o, IN(o.lineItems) l
WHERE o.customer.lastname = 'Smith' AND o.customer.firstname = 'John'
```

The following query returns the total number of orders.

```
SELECT COUNT(o)
FROM Order o
```

The following query counts the number of items in John Smith's order for which prices have been specified.

```
SELECT COUNT(l.price)
FROM Order o, IN(o.lineItems) l
WHERE o.customer.lastname = 'Smith' AND o.customer.firstname = 'John'
```

Note that this is equivalent to:

```
SELECT COUNT(l)
FROM Order o, IN(o.lineItems) l
WHERE o.customer.lastname = 'Smith' AND o.customer.firstname = 'John'
AND l.price IS NOT NULL
```

9.2.8 ORDER BY Clause

The ORDER BY clause allows the objects or values that are returned by the query to be ordered.

The syntax of the ORDER BY clause is

```
orderby_clause ::= ORDER BY orderby_item [orderby_item]*
orderby_item ::= cmp_path_expression [ASC | DESC]
```

When the ORDER BY clause is used in an EJB QL query, the SELECT clause of the query must be one of the following:

1. an identification variable *x*, denoted as OBJECT(*x*)
2. a *single_valued_cmr_path_expression*

3. a *cmp_path_expression*

In the first two cases, each *orderby_item* must be an orderable cmp-field of the entity bean abstract schema type value returned by the SELECT clause. In the third case, the *orderby_item* must evaluate to the same cmp-field of the same entity bean abstract schema type as the *cmp_path_expression* in the SELECT clause.

For example, the first two queries below are legal, but the third and fourth are not.

```
SELECT OBJECT(o)
FROM Customer c, IN(c.orders) o
WHERE c.address.state = 'CA'
ORDER BY o.quantity, o.totalcost
```

```
SELECT o.quantity
FROM Customer c, IN(c.orders) o
WHERE c.address.state = 'CA'
ORDER BY o.quantity
```

```
SELECT l.product.product_name
FROM Order o, IN(o.lineItems) l
WHERE o.customer.lastname = 'Smith' AND o.customer.firstname = 'John'
ORDER BY l.product.price
```

```
SELECT l.product.product_name
FROM Order o, IN(o.lineItems) l
WHERE o.customer.lastname = 'Smith' AND o.customer.firstname = 'John'
ORDER BY o.quantity
```

If more than one *orderby_item* is specified, the left-to-right sequence of the *orderby_item* elements determines the precedence, whereby the leftmost *orderby_item* has highest precedence.

The keyword ASC specifies that ascending ordering be used; the keyword DESC specifies that descending ordering be used. Ascending ordering is the default.

SQL rules for the ordering of null values apply: that is, all null values must appear before all non-null values in the ordering or all null values must appear after all non-null values in the ordering, but it is not specified which.

It is the container's responsibility to ensure that the ordering of the query result is preserved in the result of the finder or select method if the ORDER BY clause is used.

9.2.9 Return Value Types

The value of a query result, specified by the SELECT clause, is an entity bean abstract schema type, a cmp-field type, or the result of an aggregate function. The finder or select method with which the query is associated in the deployment descriptor determines how this result is mapped to the Java type that is visible as the result of the query method.

How the result type of a query is mapped depends on whether the query is defined for a finder method on the remote home interface, for a finder method on the local home interface, or for a select method.

- The result type of a query for a finder method must be the entity bean abstract schema type that corresponds to the entity bean type of the entity bean on whose home interface the finder method is defined. If the query is used for a finder method defined on the remote home interface of the bean, the result of the finder method is the entity bean's remote interface (or a collection of objects implementing the entity bean's remote interface). If the finder method is defined on the local home interface, the result is the entity bean's local interface (or a collection of objects implementing the entity bean's local interface).
- If the result type of a query for a select method is an entity bean abstract schema type, the return values for the query method are instances of the entity bean's local interface or instances of the entity bean's remote interface, depending on whether the value of the `result-type-mapping` deployment descriptor element contained in the `query` element for the select method is `Local` or `Remote`. The default value for `result-type-mapping` is `Local`.
- If the result type of a query used for a select method is an abstract schema type corresponding to a `cmp-field` type (excluding queries whose `SELECT` clause uses one of the aggregate functions `AVG`, `COUNT`, `MAX`, `MIN`, `SUM`), the result type of the select method is as follows:
 - If the Java type of the `cmp-field` is an object type and the select method is a single-object select method, the result of the select method is an instance of that object type. If the select method is a multi-object select method, the result is a collection of instances of that type.
 - If the Java type of the `cmp-field` is a primitive Java type (e.g., `int`), and the select method is a single-object select method, the result of the select method is that primitive type.
 - If the Java type of the `cmp-field` is a primitive Java type (e.g., `int`), and the select method is a multi-object select method, the result of the select method is a collection of values of the corresponding wrapped type (e.g., `Integer`).
- If the select method query is an aggregate query, the select method must be a single-object select method.
 - The result type of the select method must be a primitive type, a wrapped type, or an object type that is compatible with the standard JDBC conversion mappings for the type of the `cmp-field` [29].
 - If the aggregate query uses the `SUM`, `AVG`, `MAX`, or `MIN` operator, and the result type of the select method is an object type and there are no values to which the aggregate function can be applied, the select method returns null.
 - If the aggregate query uses the `SUM`, `AVG`, `MAX`, or `MIN` operator, and the result type of the select method is a primitive type and there are no values to which the aggregate function can be applied, the container must throw the `ObjectNotFoundException`.
 - If the aggregate query uses the `COUNT` operator, the result of the select method should be an exact numeric type. If there are no values to which the `COUNT` method can be applied, the result of the select method is 0.

The result of a finder or select method may contain a null value if a `cmp-field` or `cmr-field` in the query result is null.

9.2.10 Null Values

When the target of a reference does not exist in the persistent store, its value is regarded as `NULL`. SQL 92 `NULL` semantics [24] defines the evaluation of conditional expressions containing `NULL` values.

The following is a brief description of these semantics:

- Comparison or arithmetic operations with a `NULL` value always yield an unknown value.
- Two `NULL` values are not considered to be equal, the comparison yields an unknown value.
- Comparison or arithmetic operations with an unknown value always yield an unknown value.
- The `IS NULL` and `IS NOT NULL` operators convert a `NULL` cmp-field or single-valued cmr-field value into the respective `TRUE` or `FALSE` value.
- Boolean operators use three valued logic, defined by Table 8, Table 9, and Table 10.

Table 8 Definition of the AND Operator

AND	T	F	U
T	T	F	U
F	F	F	F
U	U	F	U

Table 9 Definition of the OR Operator

OR	T	F	U
T	T	T	T
F	T	F	U
U	T	U	U

Table 10 Definition of the NOT Operator

NOT	
T	F
F	T
U	U

Note: EJB QL defines the empty string, "", as a string with 0 length, which is not equal to a NULL value. However, NULL values and empty strings may not always be distinguished when queries are mapped to some persistent stores. The Bean Provider should therefore not rely on the semantics of EJB QL comparisons involving the empty string and NULL value.

9.2.11 Equality and Comparison Semantics

EJB QL only permits the values of *like* types to be compared. A type is *like* another type if they correspond to the same Java language type, or if one is a primitive Java language type and the other is the wrapped Java class type equivalent (e.g., `int` and `Integer` are like types in this sense). There is one exception to this rule: it is valid to compare numeric values for which the rules of numeric promotion apply. Conditional expressions attempting to compare non-like type values are disallowed except for this numeric case.

Note that EJB QL permits the arithmetic operators and comparison operators to be applied to cmp-fields and input parameters of the wrapped Java class equivalents to the primitive numeric Java types.

Two entity objects of the same abstract schema type are equal if and only if they have the same primary key value.

9.2.12 Restrictions

Date and time values should use the standard Java `long` millisecond value. The standard way to produce millisecond values is to use `java.util.Calendar`.

Although SQL requires support for fixed decimal comparison in arithmetic expressions, EJB QL does not. For this reason EJB QL restricts exact numeric literals to those without a decimal point (and numerics with a decimal point as an alternate representation for approximate numeric values).

Support for the `BigDecimal` and `BigInteger` types is optional for containers in EJB 2.1. Applications that depend on such types in EJB QL queries may not be portable.

`Boolean` comparison is restricted to `=` and `<>`.

EJB QL does not support the use of comments.

The data model for container-managed persistence does not currently support inheritance. Therefore, entity objects of different types cannot be compared. EJB QL queries that contain such comparisons are invalid.

9.3 Examples

The following examples illustrate the syntax and semantics of EJB QL. These examples are based on the example presented in Section 9.2.4.

9.3.1 Simple Queries

Find all orders:

```
SELECT OBJECT(o)
FROM Order o
```

Find all orders that need to be shipped to California:

```
SELECT OBJECT(o)
FROM Order o
WHERE o.shipping_address.state = 'CA'
```

Find all states for which there are orders:

```
SELECT DISTINCT o.shipping_address.state
FROM Order o
```

9.3.2 Queries with Relationships

Find all orders that have line items:

```
SELECT DISTINCT OBJECT(o)
FROM Order o, IN(o.lineItems) l
```

Note that the result of this query does not include orders with no associated line items. This query can also be written as:

```
SELECT OBJECT(o)
FROM Order o
WHERE o.lineItems IS NOT EMPTY
```

Find all orders that have no line items:

```
SELECT OBJECT(o)
FROM Order o
WHERE o.lineItems IS EMPTY
```

Find all pending orders:

```
SELECT DISTINCT OBJECT(o)
FROM Order o, IN(o.lineItems) l
WHERE l.shipped = FALSE
```

Find all orders in which the shipping address differs from the billing address. This example assumes that the Bean Provider uses two distinct entity beans to designate shipping and billing addresses, as in Figure 18.

```
SELECT OBJECT(o)
FROM Order o
WHERE
NOT (o.shipping_address.state = o.billing_address.state AND
     o.shipping_address.city = o.billing_address.city AND
     o.shipping_address.street = o.billing_address.street)
```

If the Bean Provider uses a single entity bean in two different relationships for both the shipping address and the billing address, the above expression can be simplified based on the equality rules defined in Section 9.2.11. The query can then be written as:

```
SELECT OBJECT(o)
FROM Order o
WHERE o.shipping_address <> o.billing_address
```

The query checks whether the same entity bean abstract schema type instance (identified by its primary key) is related to an order through two distinct relationships.

Find all orders for a book titled ‘Applying Enterprise JavaBeans: Component-Based Development for the J2EE Platform’:

```
SELECT DISTINCT OBJECT(o)
FROM Order o, IN(o.lineItems) l
WHERE l.product.type = 'book' AND
     l.product.name = 'Applying Enterprise JavaBeans:
     Component-Based Development for the J2EE Platform'
```

9.3.3 Queries Using Input Parameters

The following query finds the orders for a product whose name is designated by an input parameter:

```
SELECT DISTINCT OBJECT(o)
FROM Order o, IN(o.lineItems) l
WHERE l.product.name = ?1
```

For this query, the input parameter must be of the type of the cmp-field name, i.e., a string.

9.3.4 Queries for Select Methods

The following select queries illustrate the selection of values other than entity beans.

The following EJB QL query selects the names of all products that have been ordered.

```
SELECT DISTINCT l.product.name
FROM Order o, IN(o.lineItems) l
```

The following query finds the names of all products in the order specified by a particular order number. The order number is specified by a parameter that corresponds to the primary key of Order. Note that because this query does not specify `DISTINCT` in its `SELECT` clause, if it is specified for a query method whose return type is `java.util.Collection`, the collection that is returned may contain duplicates. In this example, such duplicates correspond to products that have been ordered multiple times in the given order.

```
SELECT l.product.name
FROM Order o, IN(o.lineItems) l
WHERE o.ordernumber = ?1
```

It is the responsibility of the container to interpret the query such that no duplicates are produced if the result type of the query method is `java.util.Set`.

Consider the following query for a select method:

```
SELECT o.shipping_address.city
FROM Order o
```

This query returns the names of all the cities of the shipping addresses of all orders. The result type of the select method, which is either `java.util.Collection` or `java.util.Set`, determines whether the query may return duplicate city names.

9.3.5 EJB QL and SQL

EJB QL, like SQL, treats the `FROM` clause as a cartesian product. The `FROM` clause is similar to that of SQL in that the declared identification variables affect the results of the query even if they are not used in the `WHERE` clause. The Bean Provider should use caution in defining identification variables because the domain of the query can depend on whether there are any values of the declared type.

For example, the `FROM` clause below defines a query over all orders that have line items and existing products. If there are no Product instances in the persistent store, the domain of the query is empty and no order is selected.

```
SELECT OBJECT(o)
FROM Order AS o, IN(o.lineItems) l, Product p
```

The container can represent the abstract schemas of a set of entity beans in an application using a relational database. There are multiple ways to define a mapping to a set of tables in a relational database. Although this area is beyond the scope of this specification, a sample mapping and translation of EJB QL to SQL is described to clarify the semantics of EJB QL.

A mapping strategy from a set of entity beans to a relational database might be to map each entity bean to a separate table. One-to-many relationships may be represented by foreign keys in the related table from the many side and many-to-many relationships may be represented by using an auxiliary table that contains the primary keys of the related objects.

Because the FROM clause represents a cartesian product, the SQL result may contain duplicates. If the query is for a method whose return type is `java.util.Set`, the container would therefore typically utilize a SELECT DISTINCT clause in translating the query to SQL. The query method result may contain duplicates if the return type of the query method is `java.util.Collection` and DISTINCT is not specified in the SELECT clause of the EJB QL query.

The following translation example illustrates the mapping of entity beans to relational database tables. The entity bean OrderEJB is represented by the table ORDER and the entity bean LineItemEJB is represented by the table LINEITEM. The column OKEY represents the primary key for OrderEJB entity bean, FKEY represents the foreign key column of LINEITEM that holds the values of the ORDER primary keys. FKEY is defined in the LINEITEM table to model the one-to-many relationship.

Using this mapping, the following EJB QL finder query

```
SELECT OBJECT(o)
FROM Order o, IN(o.lineItems) l
WHERE l.quantity > 5
```

might be represented in SQL as

```
SELECT DISTINCT o.OKEY
FROM ORDERBEAN o, LINEITEM l
WHERE o.OKEY = l.FKEY AND l.QUANTITY > 5
```

9.4 EJB QL BNF

EJB QL BNF notation summary:

- { ... } grouping
- [...] optional constructs
- **boldface** keywords

The following is the complete BNF notation for EJB QL:

```
EJB QL ::= select_clause from_clause [where_clause] [orderby_clause]
from_clause ::= FROM identification_variable_declaration
                [, identification_variable_declaration]*
identification_variable_declaration ::= collection_member_declaration |
                range_variable_declaration
collection_member_declaration ::= IN (collection_valued_path_expression) [AS] identifier
range_variable_declaration ::= abstract_schema_name [AS] identifier
cmp_path_expression ::=
    {identification_variable | single_valued_cmr_path_expression}.cmp_field
single_valued_cmr_path_expression ::=
    identification_variable.[single_valued_cmr_field.]* single_valued_cmr_field
single_valued_path_expression ::=
```

```

    cmp_path_expression | single_valued_cmr_path_expression
collection_valued_path_expression ::=
    identification_variable.[single_valued_cmr_field.]*collection_valued_cmr_field
select_clause ::= SELECT [DISTINCT] {select_expression | OBJECT(identification_variable)}
select_expression ::= single_valued_path_expression | aggregate_select_expression
aggregate_select_expression ::=
    { AVG | MAX | MIN | SUM | COUNT } ([DISTINCT] cmp_path_expression) |
    COUNT ([DISTINCT] identification_variable | single_valued_cmr_path_expression)
where_clause ::= WHERE conditional_expression
conditional_expression ::= conditional_term | conditional_expression OR conditional_term
conditional_term ::= conditional_factor | conditional_term AND conditional_factor
conditional_factor ::= [NOT] conditional_primary
conditional_primary ::= simple_cond_expression | (conditional_expression)
simple_cond_expression ::= comparison_expression | between_expression | like_expression |
    in_expression | null_comparison_expression |
    empty_collection_comparison_expression |
    collection_member_expression
between_expression ::=
    arithmetic_expression [NOT] BETWEEN
        arithmetic_expression AND arithmetic_expression
in_expression ::=
    cmp_path_expression [NOT] IN
        ( {literal | input_parameter} [, {literal | input_parameter} ]*)
like_expression ::=
    cmp_path_expression [NOT] LIKE pattern_value [ESCAPE escape_character]
null_comparison_expression ::=
    {single_valued_path_expression | input_parameter} IS [NOT] NULL
empty_collection_comparison_expression ::=
    collection_valued_path_expression IS [NOT] EMPTY
collection_member_expression ::=
    {single_valued_cmr_path_expression | identification_variable | input_parameter}
        [NOT] MEMBER [OF] collection_valued_path_expression
comparison_expression ::=
    string_value comparison_operator string_expression |
    boolean_value {=<>} boolean_expression |
    datetime_value comparison_operator datetime_expression |
    entity_bean_value {=<>} entity_bean_expression |
    arithmetic_value comparison_operator arithmetic_expression
arithmetic_value ::= cmp_path_expression | functions_returning_numerics
comparison_operator ::=
    = | > | >= | < | <= | <>
arithmetic_expression ::= arithmetic_term | arithmetic_expression {+ | -} arithmetic_term
arithmetic_term ::= arithmetic_factor | arithmetic_term {* | /} arithmetic_factor
arithmetic_factor ::= [{+ | -}] arithmetic_primary
arithmetic_primary ::= cmp_path_expression | literal | (arithmetic_expression) |
    input_parameter | functions_returning_numerics
string_value ::= cmp_path_expression | functions_returning_strings
string_expression ::= string_primary | input_parameter
string_primary ::= cmp_path_expression | literal | (string_expression) |
    functions_returning_strings

```

```
datetime_value ::= cmp_path_expression
datetime_expression ::= datetime_value | input_parameter
boolean_value ::= cmp_path_expression
boolean_expression ::= cmp_path_expression | literal | input_parameter
entity_bean_value ::= single_valued_cmr_path_expression | identification_variable
entity_bean_expression ::= entity_bean_value | input_parameter
functions_returning_strings ::= CONCAT(string_expression, string_expression) |
    SUBSTRING(string_expression, arithmetic_expression, arithmetic_expression)
functions_returning_numerics::=
    LENGTH(string_expression) |
    LOCATE(string_expression, string_expression[, arithmetic_expression]) |
    ABS(arithmetic_expression) |
    SQRT(arithmetic_expression) |
    MOD(arithmetic_expression, arithmetic_expression)
orderby_clause ::= ORDER BY orderby_item [, orderby_item]*
orderby_item ::= cmp_path_expression [ ASC | DESC ]
```

EJB 2.1 Entity Bean Component Contract for Bean-Managed Persistence

The entity bean component contract for bean-managed persistence is the contract between an entity bean and its container. It defines the life cycle of the entity bean instances and the model for method delegation of the client-invoked business methods. The main goal of this contract is to ensure that a component using bean-managed persistence is portable across all compliant EJB containers.

This chapter defines the Enterprise Bean Provider's view of this contract and the Container Provider's responsibility for managing the life cycle of the enterprise bean instances. It also describes the Bean Provider's responsibilities when persistence is provided by the Bean Provider.

The contents of this chapter apply only to bean-managed persistence entities as defined in the Enterprise JavaBeans 2.1 specification [3]. The contracts for persistent entities are described in the document "*Java Persistence API*" [2].

The EJB 2.1 Entity Bean Contracts have been proposed for future removal. See Section 2.7 for more details.

Note that use of dependency injection, interceptors, and Java language metadata annotations is not supported for EJB 2.1 entity beans.

10.1 Overview of Bean-Managed Entity Persistence

An entity bean implements an object view of an entity stored in an underlying database, or an entity implemented by an existing enterprise application (for example, by a mainframe program or by an ERP application). The data access protocol for transferring the state of the entity between the entity bean instances and the underlying database is referred to as object persistence.

The entity bean component protocol for bean-managed persistence allows the entity Bean Provider to implement the entity bean's persistence directly in the entity bean class or in one or more helper classes provided with the entity bean class. This chapter describes the contracts for bean-managed persistence.

Figure 19 Client View of Underlying Data Sources Accessed Through Entity Bean

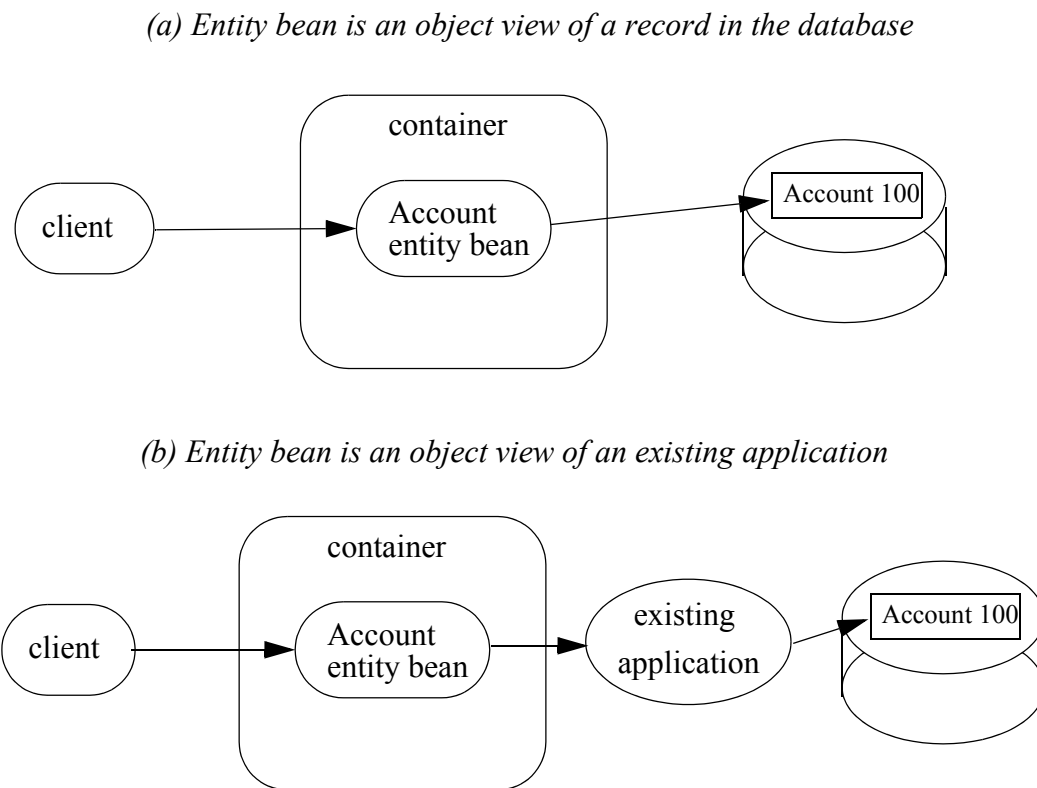

10.1.1 Entity Bean Provider's View of Persistence

Using bean-managed persistence, the entity Bean Provider writes database access calls (e.g. using JDBCTM or SQLJ) directly in the entity bean component. The data access calls are performed in the `ejbCreate<METHOD>`, `ejbRemove`, `ejbFind<METHOD>`, `ejbLoad`, and `ejbStore` methods, and/or in the business methods.

The data access calls can be coded directly into the entity bean class, or they can be encapsulated in a data access component that is part of the entity bean. Directly coding data access calls in the entity bean class may make it more difficult to adapt the entity bean to work with a database that has a different schema, or with a different type of database.

We expect that most enterprise beans with bean-managed persistence will be created by application development tools which will encapsulate data access in components. These data access components will probably not be the same for all tools. Further, if the data access calls are encapsulated in data access components, the data access components may require deployment interfaces to allow adapting data access to different schemas or even to a different database type. This EJB specification does not define the architecture for data access objects, strategies for tailoring and deploying data access components or ensuring portability of these components for bean-managed persistence.

10.1.2 Runtime Execution Model

This section describes the runtime model and the classes used in the description of the contract between an entity bean with bean-managed persistence and its container.

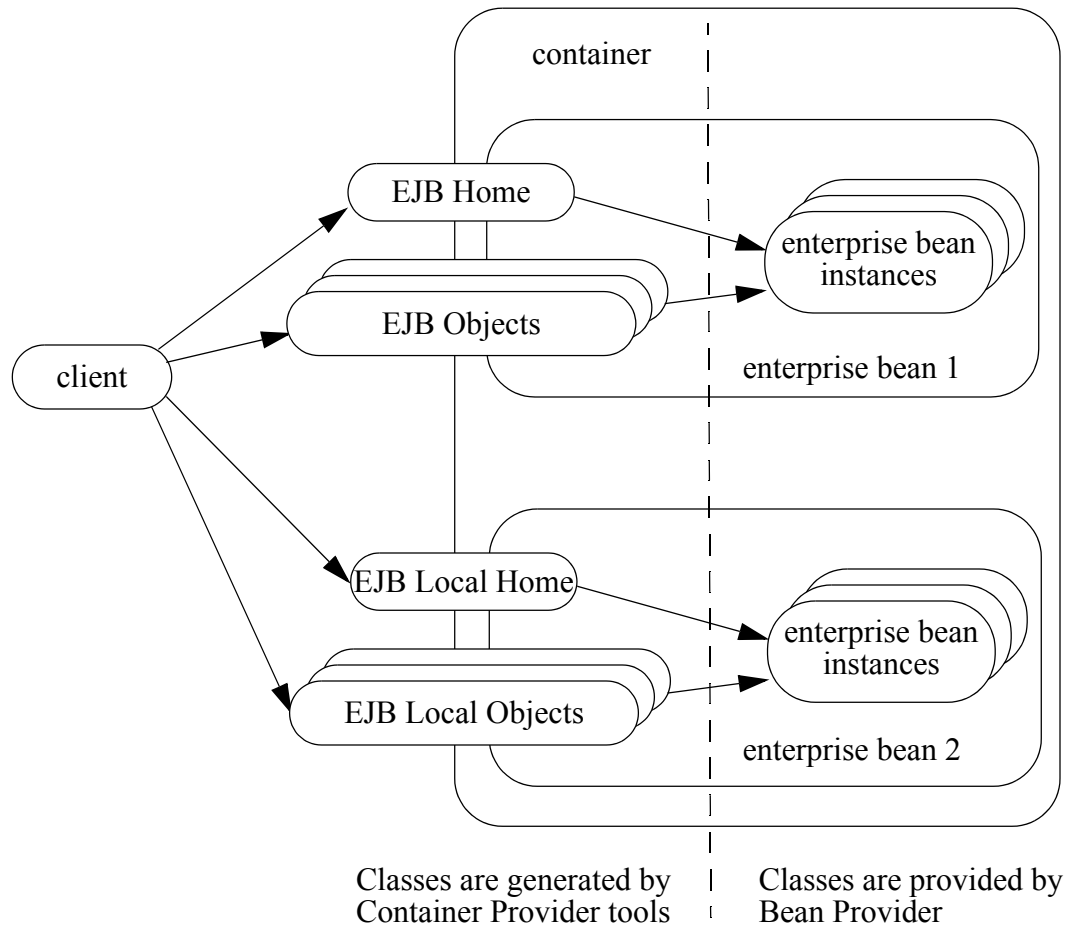
Figure 20 Overview of the Entity Bean Runtime Execution Model

An enterprise bean instance is an object whose class is provided by the Bean Provider.

An entity **EJBObject** or **EJBLocalObject** is an object whose class is generated at deployment time by the Container Provider's tools. The entity **EJBObject** class implements the entity bean's remote interface. The entity **EJBLocalObject** class implements the entity bean's local interface. A client never references an entity bean instance directly—a client always references an entity **EJBObject** or entity **EJBLocalObject** whose class is generated by the Container Provider's tools.

An entity **EJBHome** or **EJBLocalHome** object provides the life cycle operations (create, remove, find) for its entity objects as well as home business methods, which are not specific to an entity bean instance. The class for the entity **EJBHome** or **EJBLocalHome** object is generated by the Container Provider's tools at deployment time. The entity **EJBHome** or **EJBLocalHome** object implements the entity bean's home interface that was defined by the Bean Provider.

10.1.3 Instance Life Cycle

Figure 21 Life Cycle of an Entity Bean Instance.

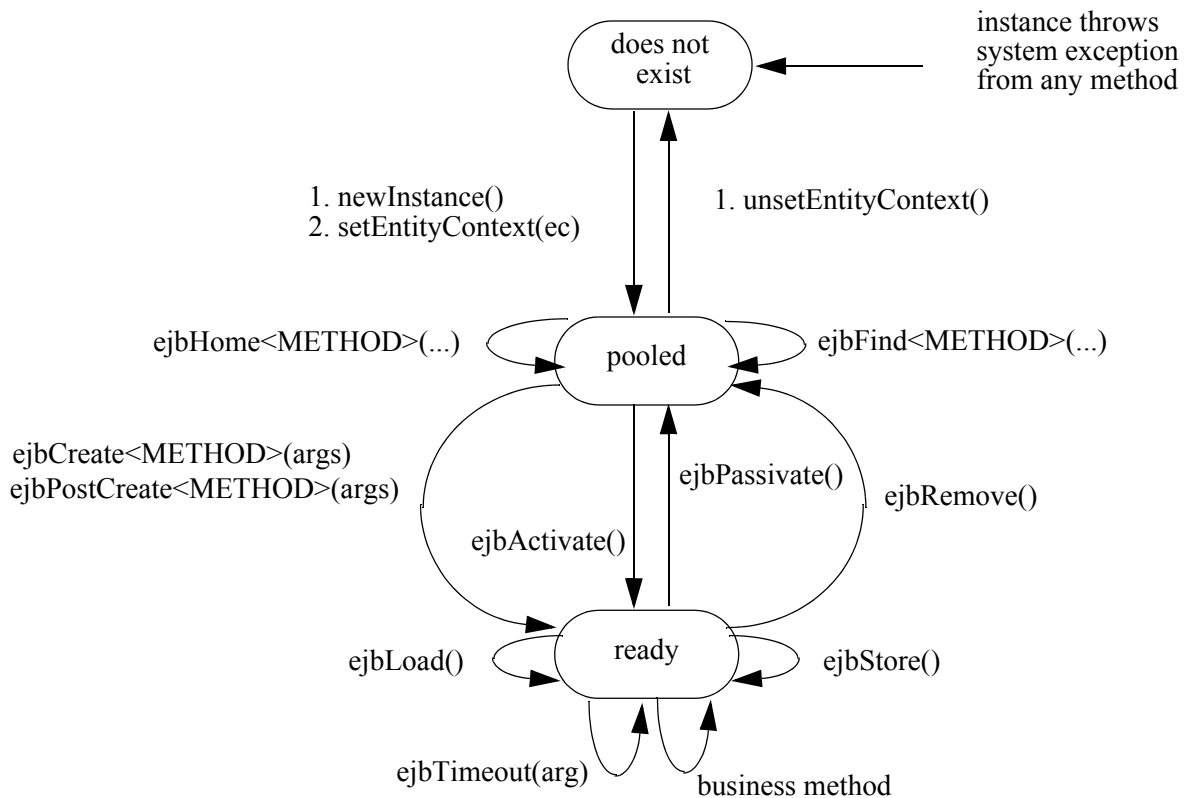

An entity bean instance is in one of the following three states:

- It does not exist.
- Pooled state. An instance in the pooled state is not associated with any particular entity object identity.
- Ready state. An instance in the ready state is assigned an entity object identity.

The following steps describe the life cycle of an entity bean instance:

- An entity bean instance's life starts when the container creates the instance using `newInstance`. The container then invokes the `setEntityContext` method to pass the instance a reference to the `EntityContext` interface. The `EntityContext` interface allows the

instance to invoke services provided by the container and to obtain the information about the caller of a client-invoked method.

- The instance enters the pool of available instances. Each entity bean has its own pool. While the instance is in the available pool, the instance is not associated with any particular entity object identity. All instances in the pool are considered equivalent, and therefore any instance can be assigned by the container to any entity object identity at the transition to the ready state. While the instance is in the pooled state, the container may use the instance to execute any of the entity bean's finder methods (shown as `ejbFind<METHOD>` in the diagram) or home methods (shown as `ejbHome<METHOD>` in the diagram). The instance does not move to the ready state during the execution of a finder or a home method.
- An instance transitions from the pooled state to the ready state when the container selects that instance to service a client call to an entity object or an `ejbTimeout` method. There are two possible transitions from the pooled to the ready state: through the `ejbCreate<METHOD>` and `ejbPostCreate<METHOD>` methods, or through the `ejbActivate` method. The container invokes the `ejbCreate<METHOD>` and `ejbPostCreate<METHOD>` methods when the instance is assigned to an entity object during entity object creation (i.e., when the client invokes a `create<METHOD>` method on the entity bean's home object). The container invokes the `ejbActivate` method on an instance when an instance needs to be activated to service an invocation on an existing entity object—this occurs because there is no suitable instance in the ready state to service the client's call or the `ejbTimeout` method.
- When an entity bean instance is in the ready state, the instance is associated with a specific entity object identity. While the instance is in the ready state, the container can invoke the `ejbLoad` and `ejbStore` methods zero or more times. A business method can be invoked on the instance zero or more times. The `ejbTimeout` method can be invoked on the instance zero or more times. Invocations of the `ejbLoad` and `ejbStore` methods can be arbitrarily mixed with invocations of business methods or the `ejbTimeout` method. The purpose of the `ejbLoad` and `ejbStore` methods is to synchronize the state of the instance with the state of the entity in the underlying data source—the container can invoke these methods whenever it determines a need to synchronize the instance's state.
- The container can choose to passivate an entity bean instance within a transaction. To passivate an instance, the container first invokes the `ejbStore` method to allow the instance to synchronize the database state with the instance's state, and then the container invokes the `ejbPassivate` method to return the instance to the pooled state.
- Eventually, the container will transition the instance to the pooled state. There are three possible transitions from the ready to the pooled state: through the `ejbPassivate` method, through the `ejbRemove` method, and because of a transaction rollback for `ejbCreate`, `ejbPostCreate`, or `ejbRemove` (not shown in Figure 21). The container invokes the `ejbPassivate` method when the container wants to disassociate the instance from the entity object identity without removing the entity object. The container invokes the `ejbRemove` method when the container is removing the entity object (i.e., when the client invoked the `remove` method on the entity object's component interface, or a `remove` method on the entity bean's home interface). If `ejbCreate`, `ejbPostCreate`, or `ejbRemove` is called and the transaction rolls back, the container will transition the bean instance to the pooled state.

- When the instance is put back into the pool, it is no longer associated with an entity object identity. The container can assign the instance to any entity object within the same entity bean home.
- An instance in the pool can be removed by calling the `unsetEntityContext` method on the instance.

Notes:

1. The `EntityContext` interface passed by the container to the instance in the `setEntityContext` method is an interface, not a class that contains static information. For example, the result of the `EntityContext.getPrimaryKey` method might be different each time an instance moves from the pooled state to the ready state, and the result of the `getCallerPrincipal` and `isCallerInRole` methods may be different in each business method.
2. A `RuntimeException` thrown from any method of the entity bean class (including the business methods and the callbacks invoked by the container) results in the transition to the “does not exist” state. The container must not invoke any method on the instance after a `RuntimeException` has been caught. From the client perspective, the corresponding entity object continues to exist. The client can continue accessing the entity object through its component interface because the container can use a different entity bean instance to delegate the client’s requests. Exception handling is described further in Chapter 14.
3. The container is not required to maintain a pool of instances in the pooled state. The pooling approach is an example of a possible implementation, but it is not the required implementation. Whether the container uses a pool or not has no bearing on the entity bean coding style.

10.1.4 The Entity Bean Component Contract

This section specifies the contract between an entity bean with bean-managed persistence and its container.

10.1.4.1 Entity Bean Instance’s View

The following describes the entity bean instance’s view of the contract:

The Bean Provider is responsible for implementing the following methods in the entity bean class:

- A public constructor that takes no arguments. The container uses this constructor to create instances of the entity bean class.
- `public void setEntityContext(EntityContext ic);`

A container uses this method to pass a reference to the `EntityContext` interface to the entity bean instance. If the entity bean instance needs to use the `EntityContext` interface during its lifetime, it must remember the `EntityContext` interface in an instance variable. This method executes with an unspecified transaction context (Refer to Subsection 13.6.5 for how the container executes methods with an unspecified transaction context). An identity of an entity object is not available during this method.

The instance can take advantage of the `setEntityContext` method to allocate any resources that are to be held by the instance for its lifetime. Such resources cannot be specific to an entity object identity because the instance might be reused during its lifetime to serve multiple entity object identities.

- `public void unsetEntityContext();`

A container invokes this method before terminating the life of the instance.

This method executes with an unspecified transaction context. An identity of an entity object is not available during this method.

The instance can take advantage of the `unsetEntityContext` method to free any resources that are held by the instance. (These resources typically had been allocated by the `setEntityContext` method.)

- `public PrimaryKeyClass ejbCreate<METHOD>(...);`

There are zero^[49] or more `ejbCreate<METHOD>` methods, whose signatures match the signatures of the `create<METHOD>` methods of the entity bean home interface. The container invokes an `ejbCreate<METHOD>` method on an entity bean instance when a client invokes a matching `create<METHOD>` method to create an entity object.

The implementation of the `ejbCreate<METHOD>` method typically validates the client-supplied arguments, and inserts a record representing the entity object into the database. The method also initializes the instance's variables. The `ejbCreate<METHOD>` method must return the primary key for the created entity object.

An `ejbCreate<METHOD>` method executes in the transaction context determined by the transaction attribute of the matching `create<METHOD>` method, as described in subsection 13.6.2.

- `public void ejbPostCreate<METHOD>(...);`

For each `ejbCreate<METHOD>` method, there is a matching `ejbPostCreate<METHOD>` method that has the same input parameters but whose return value is `void`. The container invokes the matching `ejbPostCreate<METHOD>` method on an instance after it invokes the `ejbCreate<METHOD>` method with the same arguments. The entity object identity is available during the `ejbPostCreate<METHOD>` method. The instance may, for example, obtain the component interface of the associated entity object and pass it to another enterprise bean as a method argument.

An `ejbPostCreate<METHOD>` method executes in the same transaction context as the previous `ejbCreate<METHOD>` method.

- `public void ejbActivate();`

The container invokes this method on the instance when the container picks the instance from the pool and assigns it to a specific entity object identity. The `ejbActivate` method gives the entity bean instance the chance to acquire additional resources that it needs while it is in the ready state.

[49] An entity Bean has no `ejbCreate<METHOD>` and `ejbPostCreate<METHOD>` methods if it does not define any `create` methods in its home interface. Such an entity bean does not allow the clients to create new entity objects. The entity bean restricts the clients to accessing entities that were created through direct database inserts.

This method executes with an unspecified transaction context. The instance can obtain the identity of the entity object via the `getPrimaryKey`, `getEJBLocalObject`, or `getEJBObject` method on the entity context. The instance can rely on the fact that the primary key and entity object identity will remain associated with the instance until the completion of `ejbPassivate` or `ejbRemove`.

Note that the instance should not use the `ejbActivate` method to read the state of the entity from the database; the instance should load its state only in the `ejbLoad` method.

- `public void ejbPassivate();`

The container invokes this method on an instance when the container decides to disassociate the instance from an entity object identity, and to put the instance back into the pool of available instances. The `ejbPassivate` method gives the instance the chance to release any resources that should not be held while the instance is in the pool. (These resources typically had been allocated during the `ejbActivate` method.)

This method executes with an unspecified transaction context. The instance can still obtain the identity of the entity object via the `getPrimaryKey`, `getEJBLocalObject`, or `getEJBObject` method of the `EntityContext` interface.

Note that an instance should not use the `ejbPassivate` method to write its state to the database; an instance should store its state only in the `ejbStore` method.

- `public void ejbRemove();`

The container invokes this method on an instance as a result of a client's invoking a `remove` method. The instance is in the ready state when `ejbRemove` is invoked and it will be entered into the pool when the method completes.

This method executes in the transaction context determined by the transaction attribute of the `remove` method that triggered the `ejbRemove` method. The instance can still obtain the identity of the entity object via the `getPrimaryKey`, `getEJBLocalObject`, or `getEJBObject` method of the `EntityContext` interface.

The container synchronizes the instance's state before it invokes the `ejbRemove` method. This means that the state of the instance variables at the beginning of the `ejbRemove` method is the same as it would be at the beginning of a business method.

An entity bean instance should use this method to remove the entity object's representation from the database.

Since the instance will be entered into the pool, the state of the instance at the end of this method must be equivalent to the state of a passivated instance. This means that the instance must release any resource that it would normally release in the `ejbPassivate` method.

- `public void ejbLoad();`

The container invokes this method on an instance in the ready state to inform the instance that it should synchronize the entity state cached in its instance variables from the entity state in the database. The instance should be prepared for the container to invoke this method at any time that the instance is in the ready state.

If the instance is caching the entity state (or parts of the entity state), the instance should not use the previously cached state in the subsequent business method. The instance may take advantage of the `ejbLoad` method, for example, to refresh the cached state by reading it from the database.

This method executes in the transaction context determined by the transaction attribute of the business method or `ejbTimeout` method that triggered the `ejbLoad` method.

- `public void ejbStore();`

The container invokes this method on an instance to inform the instance that the instance should synchronize the entity state in the database with the entity state cached in its instance variables. The instance should be prepared for the container to invoke this method at any time that the instance is in the ready state.

An instance should write any updates cached in the instance variables to the database in the `ejbStore` method.

This method executes in the same transaction context as the previous `ejbLoad` or `ejbCreate<METHOD>` method invoked on the instance. All business methods or the `ejbTimeout` method invoked between the previous `ejbLoad` or `ejbCreate<METHOD>` method and this `ejbStore` method are also invoked in the same transaction context.

- `public <primary key type or collection> ejbFind<METHOD>(...);`

The container invokes this method on the instance when the container selects the instance to execute a matching client-invoked `find<METHOD>` method. The instance is in the pooled state (i.e., it is not assigned to any particular entity object identity) when the container selects the instance to execute the `ejbFind<METHOD>` method on it, and it is returned to the pooled state when the execution of the `ejbFind<METHOD>` method completes.

The `ejbFind<METHOD>` method executes in the transaction context determined by the transaction attribute of the matching `find` method, as described in subsection 13.6.2.

The implementation of an `ejbFind<METHOD>` method typically uses the method's arguments to locate the requested entity object or a collection of entity objects in the database. The method must return a primary key or a collection of primary keys to the container (see Subsection 10.1.9).

- `public <type> ejbHome<METHOD>(...);`

The container invokes this method on any instance when the container selects the instance to execute a matching client-invoked `<METHOD>` home method. The instance is in the pooled state (i.e., it is not assigned to any particular entity object identity) when the container selects the instance to execute the `ejbHome<METHOD>` method on it, and it is returned to the pooled state when the execution of the `ejbHome<METHOD>` method completes.

The `ejbHome<METHOD>` method executes in the transaction context determined by the transaction attribute of the matching `<METHOD>` home method, as described in subsection 13.6.2.

- `public void ejbTimeout(...);`

The container invokes the `ejbTimeout` method on an instance when a timer for the instance has expired. The `ejbTimeout` method notifies the instance of the time-based event and allows the instance to execute the business logic to handle it.

The `ejbTimeout` method executes in the transaction context determined by its transaction attribute.

10.1.4.2 Container's View

This subsection describes the container's view of the state management contract. The container must call the following methods:

- `public void setEntityContext(ec);`

The container invokes this method to pass a reference to the `EntityContext` interface to the entity bean instance. The container must invoke this method after it creates the instance, and before it puts the instance into the pool of available instances.

The container invokes this method with an unspecified transaction context. At this point, the `EntityContext` is not associated with any entity object identity.
- `public void unsetEntityContext();`

The container invokes this method when the container wants to reduce the number of instances in the pool. After this method completes, the container must not reuse this instance.

The container invokes this method with an unspecified transaction context.
- `public PrimaryKeyClass ejbCreate<METHOD>(...);`
`public void ejbPostCreate<METHOD>(...);`

The container invokes these two methods during the creation of an entity object as a result of a client invoking a `create<METHOD>` method on the entity bean's home interface.

The container first invokes the `ejbCreate<METHOD>` method whose signature matches the `create<METHOD>` method invoked by the client. The `ejbCreate<METHOD>` method returns a primary key for the created entity object. The container creates an entity `EJBObject` reference and/or `EJBLocalObject` reference for the primary key. The container then invokes a matching `ejbPostCreate<METHOD>` method to allow the instance to fully initialize itself. Finally, the container returns the entity object's remote interface (i.e., a reference to the entity `EJBObject`) to the client if the client is a remote client, or the entity object's local interface (i.e., a reference to the entity `EJBLocalObject`) to the client if the client is a local client.

The container must invoke the `ejbCreate<METHOD>` and `ejbPostCreate<METHOD>` methods in the transaction context determined by the transaction attribute of the matching `create<METHOD>` method, as described in subsection 13.6.2.
- `public void ejbActivate();`

The container invokes this method on an entity bean instance at activation time (i.e., when the instance is taken from the pool and assigned to an entity object identity). The container must ensure that the primary key of the associated entity object is available to the instance if the instance invokes the `getPrimaryKey`, `getEJBLocalObject`, or `getEJBObject` method on its `EntityContext` interface.

The container invokes this method with an unspecified transaction context.

Note that instance is not yet ready for the delivery of a business method. The container must still invoke the `ejbLoad` method prior to a business method or `ejbTimeout` method invocation.
- `public void ejbPassivate();`

The container invokes this method on an entity bean instance at passivation time (i.e., when the instance is being disassociated from an entity object identity and moved into the pool). The

container must ensure that the identity of the associated entity object is still available to the instance if the instance invokes the `getPrimaryKey`, `getEJBLocalObject`, or `getEJBObject` method on its entity context.

The container invokes this method with an unspecified transaction context.

Note that if the instance state has been updated by a transaction, the container must first invoke the `ejbStore` method on the instance before it invokes `ejbPassivate` on it.

- `public void ejbRemove();`

The container invokes this method before it ends the life of an entity object as a result of a client invoking a `remove` operation.

The container invokes this method in the transaction context determined by the transaction attribute of the invoked `remove` method. The container must ensure that the identity of the associated entity object is still available to the instance in the `ejbRemove` method (i.e., the instance can invoke the `getPrimaryKey`, `getEJBLocalObject`, or `getEJBObject` method on its `EntityContext` in the `ejbRemove` method).

The container must ensure that the instance's state is synchronized from the state in the database before invoking the `ejbRemove` method (i.e., if the instance is not already synchronized from the state in the database, the container must invoke `ejbLoad` before it invokes `ejbRemove`).

- `public void ejbLoad();`

The container must invoke this method on the instance whenever it becomes necessary for the instance to synchronize its instance state from its state in the database. The exact times that the container invokes `ejbLoad` depend on the configuration of the component and the container, and are not defined by the EJB architecture. Typically, the container will call `ejbLoad` before the first business method within a transaction or before invoking the `ejbTimeout` method to ensure that the instance can refresh its cached state of the entity object from the database. After the first `ejbLoad` within a transaction, the container is not required to recognize that the state of the entity object in the database has been changed by another transaction, and it is not required to notify the instance of this change via another `ejbLoad` call.

The container must invoke this method in the transaction context determined by the transaction attribute of the business method or `ejbTimeout` method that triggered the `ejbLoad` method.

- `public void ejbStore();`

The container must invoke this method on the instance whenever it becomes necessary for the instance to synchronize its state in the database with the state of the instance's fields. This synchronization always happens at the end of a transaction, unless the bean is specified as read-only (see section 10.1.5). However, the container may also invoke this method when it passivates the instance in the middle of a transaction, or when it needs to transfer the most recent state of the entity object to another instance for the same entity object in the same transaction (see Subsection 13.7).

The container must invoke this method in the same transaction context as the previously invoked `ejbLoad`, `ejbCreate<METHOD>`, or `ejbTimeout` method.

- `public <primary key type or collection> ejbFind<METHOD>(...);`

The container invokes the `ejbFind<METHOD>` method on an instance when a client invokes a matching `find<METHOD>` method on the entity bean's home interface. The container must pick an instance that is in the pooled state (i.e., the instance is not associated with any entity object identity) for the execution of the `ejbFind<METHOD>` method. If there is no instance in the pooled state, the container creates one and calls the `setEntityContext` method on the instance before dispatching the finder method.

Before invoking the `ejbFind<METHOD>` method, the container must first synchronize the state of any non-read-only entity bean instances that are participating in the same transaction context as is used to execute the `ejbFind<METHOD>` by invoking the `ejbStore` method on those entity bean instances. ^[50]

After the `ejbFind<METHOD>` method completes, the instance remains in the pooled state. The container may, but is not required to, immediately activate the objects that were located by the finder using the transition through the `ejbActivate` method.

The container must invoke the `ejbFind<METHOD>` method in the transaction context determined by the transaction attribute of the matching `find` method, as described in subsection 13.6.2.

If the `ejbFind<METHOD>` method is declared to return a single primary key, the container creates an entity `EJBObject` reference for the primary key and returns it to the client if the client is a remote client. If the client is a local client, the container creates and returns an entity `EJBLocalObject` reference for the primary key. If the `ejbFind<METHOD>` method is declared to return a collection of primary keys, the container creates a collection of entity `EJBObject` or `EJBLocalObject` references for the primary keys returned from `ejbFind<METHOD>`, and returns the collection to the client. (See Subsection 10.1.9 for information on collections.)

- `public <type> ejbHome<METHOD>(...);`

The container invokes the `ejbHome<METHOD>` method on an instance when a client invokes a matching `<METHOD>` home method on the entity bean's home interface. The container must pick an instance that is in the pooled state (i.e., the instance is not associated with any entity object identity) for the execution of the `ejbHome<METHOD>` method. If there is no instance in the pooled state, the container creates one and calls the `setEntityContext` method on the instance before dispatching the home method.

After the `ejbHome<METHOD>` method completes, the instance remains in the pooled state.

The container must invoke the `ejbHome<METHOD>` method in the transaction context determined by the transaction attribute of the matching `<METHOD>` home method, as described in subsection 13.6.2.

- `public void ejbTimeout(...);`

The container invokes the `ejbTimeout` method on the instance when a timer with which the entity has been registered expires. If there is no suitable instance in the ready state, the container must activate an instance, invoking the `ejbActivate` method and transitioning it to the ready state.

The container invokes the `ejbTimeout` method in the context of a transaction determined by its transaction attribute.

[50] The EJB specification does not require the distributed flushing of state. The container in which the `ejbFind<METHOD>` method executes is not required to propagate the flush to a different container.

10.1.5 Read-only Entity Beans

Compliant implementations of this specification may optionally support read-only entity beans. A read-only entity bean is an entity bean whose instances are not intended to be updated and/or created by the application. Read-only beans are best suited for situations where the underlying data never changes or changes infrequently.

Containers that support read-only beans do not call the `ejbStore` method on them. The `ejbLoad` method should typically be called by the container when the state of the bean instance is initially loaded from the database, or at designated refresh intervals.^[51]

If a read-only bean is used, the state of such a bean should not be updated by the application, and the behavior is unspecified if this occurs.^[52]

Read-only beans are designated by vendor-specific means that are outside the scope of this specification, and their use is therefore not portable.

10.1.6 The EntityContext Interface

A container provides the entity bean instances with an `EntityContext`, which gives the entity bean instance access to the instance's context maintained by the container. The `EntityContext` interface has the following methods:

- The `getEJBObject` method returns the entity bean's remote interface.
- The `getEJBHome` method returns the entity bean's remote home interface.
- The `getEJBLocalObject` method returns the entity bean's local interface.
- The `getEJBLocalHome` method returns the entity bean's local home interface.
- The `getCallerPrincipal` method returns the `java.security.Principal` that identifies the invoker.
- The `isCallerInRole` method tests if the entity bean instance's caller has a particular role.
- The `setRollbackOnly` method allows the instance to mark the current transaction such that the only outcome of the transaction is a rollback.
- The `getRollbackOnly` method allows the instance to test if the current transaction has been marked for rollback.
- The `getPrimaryKey` method returns the entity bean's primary key.
- The `getTimerService` method returns the `javax.ejb.TimerService` interface.

[51] The ability to refresh the state of a read-only bean and the intervals at which such refresh occurs are vendor-specific.]

[52] For example, an implementation might choose to ignore such updates or to disallow them.

- The `getUserTransaction` method returns the `javax.transaction.UserTransaction` interface. Entity bean instances must not call this method.
- The `lookup` method enables the entity bean to look up its environment entries in the JNDI naming context.

10.1.7 Operations Allowed in the Methods of the Entity Bean Class

Table 11 defines the methods of an entity bean class in which the enterprise bean instances can access the methods of the `javax.ejb.EntityContext` interface, the `java:comp/env` environment naming context, resource managers, `TimerService` and `Timer` methods, the `EntityManagerFactory` and `EntityManager` methods, and other enterprise beans.

If an entity bean instance attempts to invoke a method of the `EntityContext` interface, and the access is not allowed in Table 11, the container must throw the `java.lang.IllegalStateException`.

If an entity bean instance attempts to invoke a method of the `TimerService` or `Timer` interface and the access is not allowed in Table 11, the container must throw the `java.lang.IllegalStateException`.

If an entity bean instance attempts to access a resource manager, an enterprise bean, or an entity manager or entity manager factory, and the access is not allowed in Table 11, the behavior is undefined by the EJB architecture.

Table 11 Operations Allowed in the Methods of an Entity Bean

Bean method	Bean method can perform the following operations
constructor	-
setEntityContext unsetEntityContext	EntityContext methods: <i>getEJBHome</i> , <i>getEJBLocalHome</i> , <i>lookup</i> JNDI access to <code>java:comp/env</code>
ejbCreate	EntityContext methods: <i>getEJBHome</i> , <i>getEJBLocalHome</i> , <i>getCallerPrincipal</i> , <i>getRollbackOnly</i> , <i>isCallerInRole</i> , <i>setRollbackOnly</i> , <i>getTimerService</i> , <i>lookup</i> JNDI access to <code>java:comp/env</code> Resource manager access Enterprise bean access EntityManagerFactory access EntityManager access

Table 11 Operations Allowed in the Methods of an Entity Bean

Bean method	Bean method can perform the following operations
ejbPostCreate	<p>EntityContext methods: <i>getEJBHome</i>, <i>getEJBLocalHome</i>, <i>getCallerPrincipal</i>, <i>getRollbackOnly</i>, <i>isCallerInRole</i>, <i>setRollbackOnly</i>, <i>getEJBObject</i>, <i>getEJBLocalObject</i>, <i>getPrimaryKey</i>, <i>getTimerService</i>, <i>lookup</i></p> <p>JNDI access to java:comp/env</p> <p>Resource manager access</p> <p>Enterprise bean access</p> <p>Timer service or Timer methods</p> <p>EntityManagerFactory access</p> <p>EntityManager access</p>
ejbRemove	<p>EntityContext methods: <i>getEJBHome</i>, <i>getEJBLocalHome</i>, <i>getCallerPrincipal</i>, <i>getRollbackOnly</i>, <i>isCallerInRole</i>, <i>setRollbackOnly</i>, <i>getEJBObject</i>, <i>getEJBLocalObject</i>, <i>getPrimaryKey</i>, <i>getTimerService</i>, <i>lookup</i></p> <p>JNDI access to java:comp/env</p> <p>Resource manager access</p> <p>Enterprise bean access</p> <p>Timer service or Timer methods</p> <p>EntityManagerFactory access</p> <p>EntityManager access</p>
ejbFind	<p>EntityContext methods: <i>getEJBHome</i>, <i>getEJBLocalHome</i>, <i>getCallerPrincipal</i>, <i>getRollbackOnly</i>, <i>isCallerInRole</i>, <i>setRollbackOnly</i>, <i>lookup</i></p> <p>JNDI access to java:comp/env</p> <p>Resource manager access</p> <p>Enterprise bean access</p> <p>EntityManagerFactory access</p> <p>EntityManager access</p>
ejbHome	<p>EntityContext methods: <i>getEJBHome</i>, <i>getEJBLocalHome</i>, <i>getCallerPrincipal</i>, <i>getRollbackOnly</i>, <i>isCallerInRole</i>, <i>setRollbackOnly</i>, <i>getTimerService</i>, <i>lookup</i></p> <p>JNDI access to java:comp/env</p> <p>Resource manager access</p> <p>Enterprise bean access</p> <p>EntityManagerFactory access</p> <p>EntityManager access</p>
ejbActivate ejbPassivate	<p>EntityContext methods: <i>getEJBHome</i>, <i>getEJBLocalHome</i>, <i>getEJBObject</i>, <i>getEJBLocalObject</i>, <i>getPrimaryKey</i>, <i>getTimerService</i>, <i>lookup</i></p> <p>JNDI access to java:comp/env</p>

Table 11 Operations Allowed in the Methods of an Entity Bean

Bean method	Bean method can perform the following operations
ejbLoad ejbStore	EntityContext methods: <i>getEJBHome, getEJBLocalHome, getCallerPrincipal, getRollbackOnly, isCallerInRole, setRollbackOnly, getEJBObject, getEJBLocalObject, getPrimaryKey, getTimerService, lookup</i> JNDI access to java:comp/env Resource manager access Enterprise bean access Timer service or Timer methods EntityManagerFactory access EntityManager access
business method from component interface	EntityContext methods: <i>getEJBHome, getEJBLocalHome, getCallerPrincipal, getRollbackOnly, isCallerInRole, setRollbackOnly, getEJBObject, getEJBLocalObject, getPrimaryKey, getTimerService, lookup</i> JNDI access to java:comp/env Resource manager access Enterprise bean access Timer service or Timer methods EntityManagerFactory access EntityManager access
ejbTimeout	EntityContext methods: <i>getEJBHome, getEJBLocalHome, getCallerPrincipal, isCallerInRole, getRollbackOnly, setRollbackOnly, getEJBObject, getEJBLocalObject, getPrimaryKey, getTimerService, lookup</i> JNDI access to java:comp/env Resource manager access Enterprise bean access Timer service or Timer methods EntityManagerFactory access EntityManager access

Additional restrictions:

- The `getRollbackOnly` and `setRollbackOnly` methods of the `EntityContext` interface should be used only in the enterprise bean methods that execute in the context of a transaction. The container must throw the `java.lang.IllegalStateException` if the methods are invoked while the instance is not associated with a transaction.

Reasons for disallowing operations:

- Invoking the `getEJBObject`, `getEJBLocalObject`, and `getPrimaryKey` methods is disallowed in the entity bean methods in which there is no entity object identity associated with the instance.

- Invoking the `getEJBObject` and `getEJBHome` methods is disallowed if the entity bean does not define a remote client view.
- Invoking the `getEJBLocalObject` and `getEJBLocalHome` methods is disallowed if the entity bean does not define a local client view.
- Invoking the `getRollbackOnly` and `setRollbackOnly` methods is disallowed in the entity bean methods for which the container does not have a meaningful transaction context. These are the methods that have the `NotSupported`, `Never`, or `Supports` transaction attribute.
- Accessing resource managers and enterprise beans is disallowed in the entity bean methods for which the container does not have a meaningful transaction context or client security context.

10.1.8 Caching of Entity State and the `ejbLoad` and `ejbStore` Methods

An instance of an entity bean with bean-managed persistence can cache the entity object's state between business method invocations. An instance may choose to cache the entire entity object's state, part of the state, or no state at all.

The container-invoked `ejbLoad` and `ejbStore` methods assist the instance with the management of the cached entity object's state. The instance should handle the `ejbLoad` and `ejbStore` methods as follows:

- When the container invokes the `ejbStore` method on the instance, the instance should push all cached updates of the entity object's state to the underlying database. The container invokes the `ejbStore` method at the end of a transaction^[53], and may also invoke it at other times when the instance is in the ready state. (For example the container may invoke `ejbStore` when passivating an instance in the middle of a transaction, or when transferring the instance's state to another instance to support distributed transactions in a multi-process server.)
- When the container invokes the `ejbLoad` method on the instance, the instance should discard any cached entity object's state. The instance may, but is not required to, refresh the cached state by reloading it from the underlying database.

The following examples, which are illustrative but not prescriptive, show how an instance may cache the entity object's state:

- An instance loads the entire entity object's state in the `ejbLoad` method and caches it until the container invokes the `ejbStore` method. The business methods read and write the cached entity state. The `ejbStore` method writes the updated parts of the entity object's state to the database.
- An instance loads the most frequently used part of the entity object's state in the `ejbLoad` method and caches it until the container invokes the `ejbStore` method. Additional parts of

[53] This call may be omitted if the bean has been specified as read-only.

the entity object's state are loaded as needed by the business methods. The `ejbStore` method writes the updated parts of the entity object's state to the database.

- An instance does not cache any entity object's state between business methods. The business methods access and modify the entity object's state directly in the database. The `ejbLoad` and `ejbStore` methods have an empty implementation.

We expect that most entity developers will not manually code the cache management and data access calls in the entity bean class. We expect that they will rely on application development tools to provide various data access components that encapsulate data access and provide state caching.

10.1.8.1 `ejbLoad` and `ejbStore` with the `NotSupported` Transaction Attribute

The use of the `ejbLoad` and `ejbStore` methods for caching an entity object's state in the instance works well only if the container can use transaction boundaries to drive the `ejbLoad` and `ejbStore` methods. When the `NotSupported`^[54] transaction attribute is assigned to a component interface method, the corresponding enterprise bean class method executes with an unspecified transaction context (See Subsection 13.6.5). This means that the container does not have any well-defined transaction boundaries to drive the `ejbLoad` and `ejbStore` methods on the instance.

Therefore, the `ejbLoad` and `ejbStore` methods are “unreliable” for the instances that the container uses to dispatch the methods with an unspecified transaction context. The following are the only guarantees that the container provides for the instances that execute the methods with an unspecified transaction context:

- The container invokes at least one `ejbLoad` between `ejbActivate` and the first business method in the instance.
- The container invokes at least one `ejbStore` between the last business method on the instance and the `ejbPassivate` method^[55].

Because the entity object's state accessed between the `ejbLoad` and `ejbStore` method pair is not protected by a transaction boundary for the methods that execute with an unspecified transaction context, the Bean Provider should not attempt to use the `ejbLoad` and `ejbStore` methods to control caching of the entity object's state in the instance. Typically, the implementation of the `ejbLoad` and `ejbStore` methods should be a no-op (i.e., an empty method), and each business method should access the entity object's state directly in the database.

[54] This applies also to the `Never` and `Supports` attribute.

[55] This `ejbStore` call may be omitted if the bean has been specified as read-only.

10.1.9 Finder Method Return Type

10.1.9.1 Single-Object Finder

Some finder methods (such as `ejbFindByPrimaryKey`) are designed to return at most one entity object. For single-object finders, the result type of a `find<METHOD>` method defined in the entity bean's remote home interface is the entity bean's remote interface, and the result type of the `find<METHOD>` method defined in the entity bean's local home interface is the entity bean's local interface. The result type of the corresponding `ejbFind<METHOD>` method defined in the entity's implementation class is the entity bean's primary key type.

The following code illustrates the definition of a single-object finder on the remote home interface.

```
// Entity's home interface
public AccountHome extends javax.ejb.EJBHome {
    ...
    Account findByPrimaryKey(AccountPrimaryKey primkey)
        throws FinderException, RemoteException;
    ...
}
```

Note that a finder method defined on the local home interface, however, must not throw the RemoteException.

```
// Entity's implementation class
public AccountBean implements javax.ejb.EntityBean {
    ...
    public AccountPrimaryKey ejbFindByPrimaryKey(
        AccountPrimaryKey primkey)
        throws FinderException
    {
        ...
    }
    ...
}
```

10.1.9.2 Multi-Object Finders

Some finder methods are designed to return multiple entity objects. For multi-object finders defined in the entity bean's remote home interface, the result type of the `find<METHOD>` method is a collection of objects implementing the entity bean's remote interface. For multi-object finders defined in the entity bean's local home interface, the result type is a collection of objects implementing the entity bean's local interface. In either case, the result type of the corresponding `ejbFind<METHOD>` implementation method defined in the entity bean's implementation class is a collection of objects of the entity bean's primary key type.

The Bean Provider can choose two types to define a collection type for a finder:

- the Java™ 2 `java.util.Collection` interface
- the JDK™ 1.1 `java.util.Enumeration` interface

A Bean Provider targeting containers and clients based on Java 2 should use the `java.util.Collection` interface for the finder's result type.

A Bean Provider who wants to ensure that the entity bean is compatible with containers and clients based on JDK 1.1 must use the `java.util.Enumeration` interface for the finder's result type^[56].

The Bean Provider must ensure that the objects in the `java.util.Enumeration` or `java.util.Collection` returned from the `ejbFind<METHOD>` method are instances of the entity bean's primary key class.

A client program must use the `PortableRemoteObject.narrow` method to convert the objects contained in the collections returned by a finder method on the entity bean's remote home interface to the entity bean's remote interface type.

The following is an example of a multi-object finder method definition that is compatible with containers and clients based on Java 2:

```
// Entity's remote home interface
public AccountHome extends javax.ejb.EJBHome {
    ...
    java.util.Collection findLargeAccounts(double limit)
        throws FinderException, RemoteException;
    ...
}

// Entity's implementation class
public AccountBean implements javax.ejb.EntityBean {
    ...
    public java.util.Collection ejbFindLargeAccounts(
        double limit) throws FinderException
    {
        ...
    }
    ...
}
```

[56] The finder will be also compatible with Java 2-based containers and clients.

The following is an example of a multi-object finder method definition compatible with containers and clients that are based on both JDK 1.1 and Java 2:

```
// Entity's remote home interface
public AccountHome extends javax.ejb.EJBHome {
    ...
    java.util.Enumeration findLargeAccounts(double limit)
        throws FinderException, RemoteException;
    ...
}

// Entity's implementation class
public AccountBean implements javax.ejb.EntityBean {
    ...
    public java.util.Enumeration ejbFindLargeAccounts(
        double limit) throws FinderException
    {
        ...
    }
    ...
}
```

10.1.10 Timer Notifications

An entity bean can be registered with the EJB Timer Service for time-based event notifications if it implements the `javax.ejb.TimedObject` interface. The container invokes the bean instance's `ejbTimeout` method when a timer for the bean has expired. See Chapter 18, "Timer Service".

10.1.11 Standard Application Exceptions for Entities

The EJB specification defines the following standard application exceptions:

- `javax.ejb.CreateException`
- `javax.ejb.DuplicateKeyException`
- `javax.ejb.FinderException`
- `javax.ejb.ObjectNotFoundException`
- `javax.ejb.RemoveException`

10.1.11.1 CreateException

From the client's perspective, a `CreateException` (or a subclass of `CreateException`) indicates that an application level error occurred during the `create<METHOD>` operation. If a client receives this exception, the client does not know, in general, whether the entity object was created but not fully initialized, or not created at all. Also, the client does not know whether or not the transaction has been marked for rollback. (However, the client may determine the transaction status using the `UserTransaction` interface or the `setRollbackOnly` method of the `EJBContext` interface.)

The Bean Provider throws the `CreateException` (or subclass of `CreateException`) from the `ejbCreate<METHOD>` and `ejbPostCreate<METHOD>` methods to indicate an application-level error from the create or initialization operation. Optionally, the Bean Provider may mark the transaction for rollback before throwing this exception.

The Bean Provider is encouraged to mark the transaction for rollback only if data integrity would be lost if the transaction were committed by the client. Typically, when a `CreateException` is thrown, it leaves the database in a consistent state, allowing the client to recover. For example, `ejbCreate` may throw the `CreateException` to indicate that some of the arguments to the `create<METHOD>` method are invalid.

The container treats the `CreateException` as any other application exception. See Section 14.3.

10.1.11.2 DuplicateKeyException

The `DuplicateKeyException` is a subclass of `CreateException`. It is thrown by the `ejbCreate<METHOD>` method to indicate to the client that the entity object cannot be created because an entity object with the same key already exists. The unique key causing the violation may be the primary key, or another key defined in the underlying database.

Normally, the Bean Provider should not mark the transaction for rollback before throwing the exception.

When the client receives the `DuplicateKeyException`, the client knows that the entity was not created, and that the client's transaction has not typically been marked for rollback.

10.1.11.3 FinderException

From the client's perspective, a `FinderException` (or a subclass of `FinderException`) indicates that an application level error occurred during the `find` operation. Typically, the client's transaction has not been marked for rollback because of the `FinderException`.

The Bean Provider throws the `FinderException` (or subclass of `FinderException`) from the `ejbFind<METHOD>` method to indicate an application-level error in the finder method. The Bean Provider should not, typically, mark the transaction for rollback before throwing the `FinderException`.

The container treats the `FinderException` as any other application exception. See Section 14.3.

10.1.11.4 ObjectNotFoundException

The `ObjectNotFoundException` is a subclass of `FinderException`. It is thrown by the `ejbFind<METHOD>` method to indicate that the requested entity object does not exist.

Only single-object finders (see Subsection 10.1.9) should throw this exception. Multi-object finders must not throw this exception. Multi-object finders should return an empty collection as an indication that no matching objects were found.

10.1.11.5 RemoveException

From the client's perspective, a `RemoveException` (or a subclass of `RemoveException`) indicates that an application level error occurred during a `remove` operation. If a client receives this exception, the client does not know, in general, whether the entity object was removed or not. The client also does not know if the transaction has been marked for rollback. (However, the client may determine the transaction status using the `UserTransaction` interface.)

The Bean Provider throws the `RemoveException` (or subclass of `RemoveException`) from the `ejbRemove` method to indicate an application-level error from the entity object removal operation. Optionally, the Bean Provider may mark the transaction for rollback before throwing this exception.

The Bean Provider is encouraged to mark the transaction for rollback only if data integrity would be lost if the transaction were committed by the client. Typically, when a `RemoveException` is thrown, it leaves the database in a consistent state, allowing the client to recover.

The container treats the `RemoveException` as any other application exception. See Section 14.3.

10.1.12 Commit Options

The Entity Bean protocol is designed to give the container the flexibility to select the disposition of the instance state at transaction commit time. This flexibility allows the container to optimally manage the caching of entity object's state and the association of an entity object identity with the enterprise bean instances.

The container can select from the following commit-time options:

- **Option A:** The container caches a "ready" instance between transactions. The container ensures that the instance has exclusive access to the state of the object in the persistent storage. Therefore, the container does not have to synchronize the instance's state from the persistent storage at the beginning of the next transaction.
- **Option B:** The container caches a "ready" instance between transactions. In contrast to Option A, in this option the container does not ensure that the instance has exclusive access to the state of the object in the persistent storage. Therefore, the container must synchronize the instance's state from the persistent storage at the beginning of the next transaction.
- **Option C:** The container does not cache a "ready" instance between transactions. The container returns the instance to the pool of available instances after a transaction has completed.

The following table provides a summary of the commit-time options.

Table 12 Summary of Commit-Time Options

	Write instance state to database	Instance stays ready	Instance state remains valid
Option A	Yes	Yes	Yes

Table 12 Summary of Commit-Time Options

	Write instance state to database	Instance stays ready	Instance state remains valid
Option B	Yes	Yes	No
Option C	Yes	No	No

Note that the container synchronizes the instance's state with the persistent storage at transaction commit for all three options.

The selection of the commit option is transparent to the entity bean implementation—the entity bean will work correctly regardless of the commit-time option chosen by the container. The Bean Provider writes the entity bean in the same way.

10.1.13 Concurrent Access from Multiple Transactions

When writing the entity bean business methods, the Bean Provider does not have to worry about concurrent access from multiple transactions. The Bean Provider may assume that the container will ensure appropriate synchronization for entity objects that are accessed concurrently from multiple transactions.

The container typically uses one of the following implementation strategies to achieve proper synchronization. (These strategies are illustrative, not prescriptive.)

- The container activates multiple instances of the entity bean, one for each transaction in which the entity object is being accessed. The transaction synchronization is performed automatically by the underlying database during the database access calls performed by the business methods and the `ejbTimeout` method; and by the `ejbLoad`, `ejbCreate<METHOD>`, `ejbStore`, and `ejbRemove` methods. The database system provides all the necessary transaction synchronization; the container does not have to perform any synchronization logic.

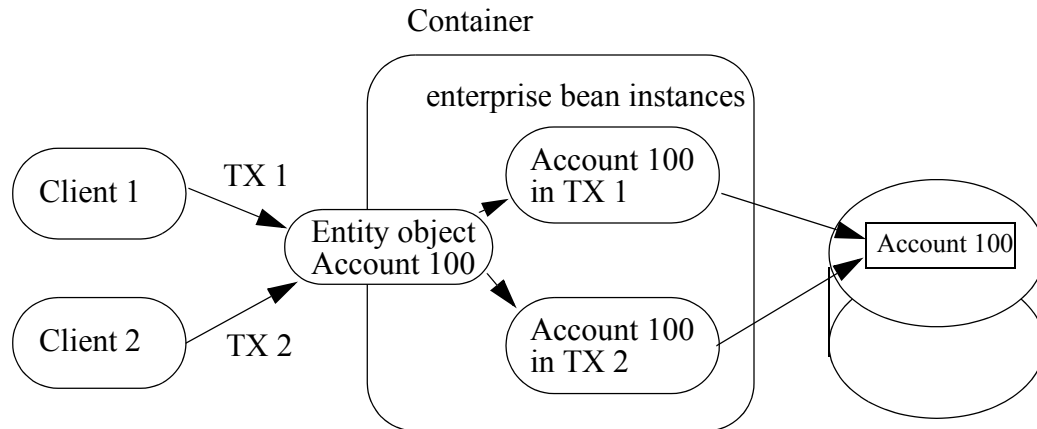
Figure 22 Multiple Clients Can Access the Same Entity Object Using Multiple Instances

With this strategy, the type of lock acquired by `ejbLoad` leads to a trade-off. If `ejbLoad` acquires an exclusive lock on the instance's state in the database, then throughput of read-only transactions could be impacted. If `ejbLoad` acquires a shared lock and the instance is updated, then `ejbStore` will need to promote the lock to an exclusive lock. This may cause a deadlock if it happens concurrently under multiple transactions.

- The container acquires exclusive access to the entity object's state in the database. The container activates a single instance and serializes the access from multiple transactions to this instance. The commit-time option A applies to this type of container.

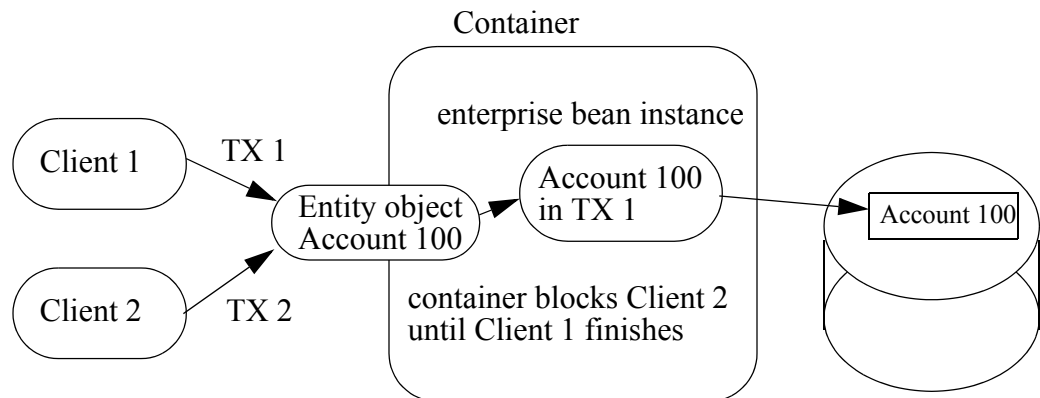
Figure 23 Multiple Clients Can Access the Same Entity Object Using Single Instance

10.1.14 Non-reentrant and Re-entrant Instances

An entity Bean Provider can specify that an entity bean is non-reentrant. If an instance of a non-reentrant entity bean executes a client request in a given transaction context, and another request with the same transaction context arrives for the same entity object, the container will throw an exception to the second request. This rule allows the Bean Provider to program the entity bean as single-threaded, non-reentrant code.

The functionality of some entity beans may require loopbacks in the same transaction context. An example of a loopback is when the client calls entity object A, A calls entity object B, and B calls back A in the same transaction context. The entity bean's method invoked by the loopback shares the current execution context (which includes the transaction and security contexts) with the bean's method invoked by the client.

If the entity bean is specified as non-reentrant in the deployment descriptor, the container must reject an attempt to re-enter the instance via the entity bean's component interface while the instance is executing a business method. (This can happen, for example, if the instance has invoked another enterprise bean, and the other enterprise bean tries to make a loopback call.) If the attempt is made to reenter the instance through the remote interface, the container must throw the `java.rmi.RemoteException` to the caller. If the attempt is made to reenter the instance through the local interface, the container must throw the `javax.ejb.EJBException` to the caller. The container must allow the call if the bean's deployment descriptor specifies that the entity bean is re-entrant.

Re-entrant entity beans must be programmed and used with caution. First, the Bean Provider must code the entity bean with the anticipation of a loopback call. Second, since the container cannot, in general, tell a loopback from a concurrent call from a different client, the client programmer must be careful to avoid code that could lead to a concurrent call in the same transaction context.

Concurrent calls in the same transaction context targeted at the same entity object are illegal and may lead to unpredictable results. Since the container cannot, in general, distinguish between an illegal concurrent call and a legal loopback, application programmers are encouraged to avoid using loopbacks. Entity beans that do not need callbacks should be marked as non-reentrant in the deployment descriptor, allowing the container to detect and prevent illegal concurrent calls from clients.

10.2 Responsibilities of the Enterprise Bean Provider

This section describes the responsibilities of a bean-managed persistence entity Bean Provider to ensure that the entity bean can be deployed in any EJB container.

10.2.1 **Classes and Interfaces**

The Bean Provider is responsible for providing the following class files:

- Entity bean class and any dependent classes
- Primary key class
- Entity bean's remote interface and remote home interface, if the entity bean provides a remote client view
- Entity bean's local interface and local home interface, if the entity bean provides a local client view

The Bean Provider must provide a remote interface and a remote home interface or a local interface and a local home interface for the bean. The Bean Provider may provide a remote interface, remote home interface, local interface, and local home interface for the bean. Other combinations are not allowed.

10.2.2 **Enterprise Bean Class**

The following are the requirements for an entity bean class:

The class must implement, directly or indirectly, the `javax.ejb.EntityBean` interface.

The class may implement, directly or indirectly, the `javax.ejb.TimerObject` interface.

The class must be defined as `public` and must not be `abstract`. The class must be a top level class.

The class must not be defined as `final`.

The class must define a public constructor that takes no arguments.

The class must not define the `finalize` method.

The class may, but is not required to, implement the entity bean's component interface^[57]. If the class implements the entity bean's component interface, the class must provide no-op implementations of the methods defined in the `javax.ejb.EJBObject` or `javax.ejb.EJBLocalObject` interface. The container will never invoke these methods on the bean instances at runtime.

A no-op implementation of these methods is required to avoid defining the entity bean class as abstract.

The entity bean class must implement the business methods, and the `ejbCreate<METHOD>`, `ejbPostCreate<METHOD>`, `ejbFind<METHOD>`, and `ejbHome<METHOD>` methods as described later in this section.

The entity bean class may have superclasses and/or superinterfaces. If the entity bean has superclasses, the business methods, the `ejbCreate` and `ejbPostCreate` methods, the finder methods, and the methods of the `EntityBean` interface or the `TimedObject` interface may be implemented in the enterprise bean class or in any of its superclasses.

The entity bean class is allowed to implement other methods (for example helper methods invoked internally by the business methods) in addition to the methods required by the EJB specification.

10.2.3 `ejbCreate<METHOD>` Methods

The entity bean class must implement the `ejbCreate<METHOD>` methods that correspond to the `create<METHOD>` methods specified in the entity bean's home interface.

The entity bean class may define zero or more `ejbCreate<METHOD>` methods whose signatures must follow these rules:

The method name must have `ejbCreate` as its prefix.

The method must be declared as `public`.

The method must not be declared as `final` or `static`.

The return type must be the entity bean's primary key type.

The method argument and return value types must be legal types for RMI-IIOP if the `ejbCreate<METHOD>` corresponds to a `create<METHOD>` on the entity bean's remote home interface.

The `throws` clause may define arbitrary application specific exceptions, including the `javax.ejb.CreateException`.

[57] If the entity bean class does implement the component interface, care must be taken to avoid passing of `this` as a method argument or result. This potential error can be avoided by choosing not to implement the component interface in the entity bean class.

Compatibility Note: EJB 1.0 allowed the `ejbCreate` method to throw the `java.rmi.RemoteException` to indicate a non-application exception. This practice was deprecated in EJB 1.1—an EJB 1.1 or EJB 2.0 or later compliant enterprise bean should throw the `javax.ejb.EJBException` or another `java.lang.RuntimeException` to indicate non-application exceptions to the container (see Section 14.2.2). An EJB 2.0 or later enterprise bean should not throw the `java.rmi.RemoteException` from the `ejbCreate` method.

The entity object created by the `ejbCreate<METHOD>` method must have a unique primary key. This means that the primary key must be different from the primary keys of all the existing entity objects within the same home. The `ejbCreate<METHOD>` method should throw the `DuplicateKeyException` on an attempt to create an entity object with a duplicate primary key. However, it is legal to reuse the primary key of a previously removed entity object.

10.2.4 `ejbPostCreate<METHOD>` Methods

For each `ejbCreate<METHOD>` method, the entity bean class must define a matching `ejbPostCreate<METHOD>` method, using the following rules:

The method name must have `ejbPostCreate` as its prefix.

The method must be declared as `public`.

The method must not be declared as `final` or `static`.

The return type must be `void`.

The method arguments must be the same as the arguments of the matching `ejbCreate<METHOD>` method.

The `throws` clause may define arbitrary application specific exceptions, including the `javax.ejb.CreateException`.

Compatibility Note: EJB 1.0 allowed the `ejbPostCreate` method to throw the `java.rmi.RemoteException` to indicate a non-application exception. This practice was deprecated in EJB 1.1—an EJB 1.1 or EJB 2.0 or later compliant enterprise bean should throw the `javax.ejb.EJBException` or another `java.lang.RuntimeException` to indicate non-application exceptions to the container (see Section 14.2.2). An EJB 2.0 or later enterprise bean should not throw the `java.rmi.RemoteException` from the `ejbPostCreate` method.

10.2.5 `ejbFind` Methods

The entity bean class may also define additional `ejbFind<METHOD>` finder methods.

The signatures of the finder methods must follow the following rules:

A finder method name must start with the prefix “`ejbFind`” (e.g. `ejbFindByPrimaryKey`, `ejbFindLargeAccounts`, `ejbFindLateShipments`).

A finder method must be declared as `public`.

The method must not be declared as `final` or `static`.

The method argument types must be legal types for RMI-IIOP if the `ejbFind<METHOD>` method corresponds to a `find<METHOD>` method on the entity bean's remote home interface.

The return type of a finder method must be the entity bean's primary key type, or a collection of primary keys (see Subsection 10.1.9).

The `throws` clause may define arbitrary application specific exceptions, including the `javax.ejb.FinderException`.

Compatibility Note: EJB 1.0 allowed the finder methods to throw the `java.rmi.RemoteException` to indicate a non-application exception. This practice was deprecated in EJB 1.1—an EJB 1.1 or EJB 2.0 or later compliant enterprise bean should throw the `javax.ejb.EJBException` or another `java.lang.RuntimeException` to indicate non-application exceptions to the container (see Section 14.2.2). An EJB 2.0 or later enterprise bean should not throw the `java.rmi.RemoteException` from the `ejbFind` method.

Every entity bean must define the `ejbFindByPrimaryKey` method. The result type for this method must be the primary key type (i.e., the `ejbFindByPrimaryKey` method must be a single-object finder).

10.2.6 `ejbHome<METHOD>` Methods

The entity bean class may define zero or more home methods whose signatures must follow the following rules:

An `ejbHome<METHOD>` method must exist for every home `<METHOD>` method on the entity bean's remote home or local home interface. The method name must have `ejbHome` as its prefix followed by the name of the `<METHOD>` method in which the first character has been uppercased.

The method must be declared as `public`.

The method must not be declared as `static`.

The method argument and return value types must be legal types for RMI-IIOP if the `ejbHome` method corresponds to a method on the entity bean's remote home interface.

The `throws` clause may define arbitrary application specific exceptions. The `throws` clause must not throw the `java.rmi.RemoteException`.

10.2.7 Business Methods

The entity bean class may define zero or more business methods whose signatures must follow these rules:

The method names can be arbitrary, but they must not start with ‘`ejb`’ to avoid conflicts with the callback methods used by the EJB architecture.

The business method must be declared as `public`.

The method must not be declared as `final` or `static`.

The method argument and return value types must be legal types for RMI-IIOP if the method corresponds to a business method on the entity bean’s remote interface.

The `throws` clause may define arbitrary application specific exceptions.

Compatibility Note: EJB 1.0 allowed the business methods to throw the `java.rmi.RemoteException` to indicate a non-application exception. This practice was deprecated in EJB 1.1—an EJB 1.1 or EJB 2.0 or later compliant enterprise bean should throw the `javax.ejb.EJBException` or another `java.lang.RuntimeException` to indicate non-application exceptions to the container (see Section 14.2.2). An EJB 2.0 or later enterprise bean should not throw the `java.rmi.RemoteException` from a business method.

10.2.8 Entity Bean’s Remote Interface

The following are the requirements for the entity bean’s remote interface:

The interface must extend the `javax.ejb.EJBObject` interface.

The methods defined in the remote interface must follow the rules for RMI-IIOP. This means that their argument and return value types must be valid types for RMI-IIOP, and their `throws` clauses must include the `java.rmi.RemoteException`.

The remote interface is allowed to have superinterfaces. Use of interface inheritance is subject to the RMI-IIOP rules for the definition of remote interfaces.

For each method defined in the remote interface, there must be a matching method in the entity bean’s class. The matching method must have:

- The same name.
- The same number and types of its arguments, and the same return type.
- All the exceptions defined in the `throws` clause of the matching method of the enterprise bean class must be defined in the `throws` clause of the method of the remote interface.

The remote interface methods must not expose local interface types, local home interface types, timers or timer handles, or the managed collection classes that are used for entity beans with container-managed persistence as arguments or results.

10.2.9 Entity Bean's Remote Home Interface

The following are the requirements for the entity bean's remote home interface:

The interface must extend the `javax.ejb.EJBHome` interface.

The methods defined in this interface must follow the rules for RMI-IIOP. This means that their argument and return types must be of valid types for RMI-IIOP, and that their `throws` clauses must include the `java.rmi.RemoteException`.

The remote home interface is allowed to have superinterfaces. Use of interface inheritance is subject to the RMI-IIOP rules for the definition of remote interfaces.

Each method defined in the remote home interface must be one of the following:

- A create method.
- A finder method.
- A home method.

Each `create` method must be named “`create<METHOD>`”, and it must match one of the `ejbCreate<METHOD>` methods defined in the enterprise bean class. The matching `ejbCreate<METHOD>` method must have the same number and types of its arguments. (Note that the return type is different.)

The return type for a `create<METHOD>` method must be the entity bean's remote interface type.

All the exceptions defined in the `throws` clause of the matching `ejbCreate<METHOD>` and `ejbPostCreate<METHOD>` methods of the enterprise bean class must be included in the `throws` clause of the matching `create<METHOD>` method of the remote home interface (i.e., the set of exceptions defined for the `create<METHOD>` method must be a superset of the union of exceptions defined for the `ejbCreate<METHOD>` and `ejbPostCreate<METHOD>` methods).

The `throws` clause of a `create<METHOD>` method must include the `javax.ejb.CreateException`.

Each `finder` method must be named “`find<METHOD>`” (e.g. `findLargeAccounts`), and it must match one of the `ejbFind<METHOD>` methods defined in the entity bean class (e.g. `ejbFindLargeAccounts`). The matching `ejbFind<METHOD>` method must have the same number and types of arguments. (Note that the return type may be different.)

The return type for a `find<METHOD>` method must be the entity bean's remote interface type (for a single-object finder), or a collection thereof (for a multi-object finder).

The remote home interface must always include the `findByPrimaryKey` method, which is always a single-object finder. The method must declare the primary key class as the method argument.

All the exceptions defined in the `throws` clause of an `ejbFind` method of the entity bean class must be included in the `throws` clause of the matching `find` method of the remote home interface.

The `throws` clause of a `finder` method must include the `javax.ejb.FinderException`.

Home methods can have arbitrary names, provided that they do not clash with `create`, `find`, and `remove` method names. The matching `ejbHome` method specified in the entity bean class must have the same number and types of arguments and must return the same type as the home method as specified in the remote home interface of the bean.

The remote home interface methods must not expose local interface types, local home interface types, timer handles, or the managed collection classes that are used for entity beans with container-managed persistence as arguments or results.

10.2.10 Entity Bean's Local Interface

The following are the requirements for the entity bean's local interface:

The interface must extend the `javax.ejb.EJBLocalObject` interface.

The `throws` clause of a method defined on the local interface must not include the `java.rmi.RemoteException`.

The local interface is allowed to have superinterfaces.

For each method defined in the local interface, there must be a matching method in the entity bean's class. The matching method must have:

- The same name.
- The same number and types of its arguments, and the same return type.
- All the exceptions defined in the `throws` clause of the matching method of the enterprise Bean class must be defined in the `throws` clause of the method of the local interface.

10.2.11 Entity Bean's Local Home Interface

The following are the requirements for the entity bean's local home interface:

The interface must extend the `javax.ejb.EJBLocalHome` interface.

The `throws` clause of a method on the local home interface must not include the `java.rmi.RemoteException`.

The local home interface is allowed to have superinterfaces.

Each method defined in the local home interface must be one of the following:

- A create method.
- A finder method.
- A home method.

Each `create` method must be named “`create<METHOD>`”, and it must match one of the `ejbCreate<METHOD>` methods defined in the enterprise bean class. The matching `ejbCreate<METHOD>` method must have the same number and types of its arguments. (Note that the return type is different.)

The return type for a `create<METHOD>` method must be the entity bean’s local interface type.

All the exceptions defined in the `throws` clause of the matching `ejbCreate<METHOD>` and `ejbPostCreate<METHOD>` methods of the enterprise bean class must be included in the `throws` clause of the matching `create<METHOD>` method of the local home interface (i.e., the set of exceptions defined for the `create<METHOD>` method must be a superset of the union of exceptions defined for the `ejbCreate<METHOD>` and `ejbPostCreate<METHOD>` methods).

The `throws` clause of a `create<METHOD>` method must include the `javax.ejb.CreateException`.

Each finder method must be named “`find<METHOD>`” (e.g. `findLargeAccounts`), and it must match one of the `ejbFind<METHOD>` methods defined in the entity bean class (e.g. `ejbFindLargeAccounts`). The matching `ejbFind<METHOD>` method must have the same number and types of arguments. (Note that the return type may be different.)

The return type for a `find<METHOD>` method must be the entity bean’s local interface type (for a single-object finder), or a collection thereof (for a multi-object finder).

The local home interface must always include the `findByPrimaryKey` method, which is always a single-object finder. The method must declare the primary key class as the method argument.

All the exceptions defined in the `throws` clause of an `ejbFind` method of the entity bean class must be included in the `throws` clause of the matching `find` method of the local home interface.

The `throws` clause of a finder method must include the `javax.ejb.FinderException`.

Home methods can have arbitrary names, provided that they do not clash with `create`, `find`, and `remove` method names. The matching `ejbHome` method specified in the entity bean class must have the same number and types of arguments and must return the same type as the home method as specified in the local home interface of the bean.

The `throws` clause of any method on the entity bean’s local home interface must not include the `java.rmi.RemoteException`.

10.2.12 Entity Bean’s Primary Key Class

The Bean Provider must specify a primary key class in the deployment descriptor.

The primary key type must be a legal Value Type in RMI-IIOP.

The class must provide suitable implementation of the `hashCode()` and `equals(Object other)` methods to simplify the management of the primary keys by client code.

10.3 The Responsibilities of the Container Provider

This section describes the responsibilities of the Container Provider to support bean-managed persistence entity beans. The Container Provider is responsible for providing the deployment tools, and for managing entity bean instances at runtime.

Because the EJB specification does not define the API between deployment tools and the container, we assume that the deployment tools are provided by the Container Provider. Alternatively, the deployment tools may be provided by a different vendor who uses the container vendor's specific API.

10.3.1 Generation of Implementation Classes

The deployment tools provided by the Container Provider are responsible for the generation of additional classes when the entity bean is deployed. The tools obtain the information that they need for generation of the additional classes by introspecting the classes and interfaces provided by the entity Bean Provider and by examining the entity bean's deployment descriptor.

The deployment tools must generate the following classes:

- A class that implements the entity bean's remote home interface (i.e., the entity `EJBHome` class).
- A class that implements the entity bean's remote interface (i.e., the entity `EJBObject` class).
- A class that implements the entity bean's local home interface (i.e., the entity `EJBLocalHome` class).
- A class that implements the entity bean's local interface (i.e., the entity `EJBLocalObject` class).

The deployment tools may also generate a class that mixes some container-specific code with the entity bean class. The code may, for example, help the container to manage the entity bean instances at runtime. Tools can use subclassing, delegation, and code generation.

The deployment tools may also allow generation of additional code that wraps the business methods and that is used to customize the business logic for an existing operational environment. For example, a wrapper for a `debit` function on the `Account` bean may check that the debited amount does not exceed a certain limit, or perform security checking that is specific to the operational environment.

10.3.2 Entity EJBHome Class

The entity EJBHome class, which is generated by deployment tools, implements the entity bean's remote home interface. This class implements the methods of the `javax.ejb.EJBHome` interface, and the type-specific create, finder, and home methods specific to the entity bean.

The implementation of each `create<METHOD>` method invokes a matching `ejbCreate<METHOD>` method, followed by the matching `ejbPostCreate<METHOD>` method, passing the `create<METHOD>` parameters to these matching methods.

The implementation of the `remove` methods defined in the `javax.ejb.EJBHome` interface must activate an instance (if an instance is not already in the ready state) and invoke the `ejbRemove` method on the instance.

The implementation of each `find<METHOD>` method invokes a matching `ejbFind<METHOD>` method. The implementation of the `find<METHOD>` method must create an entity object reference for the primary key returned from the `ejbFind<METHOD>` and return the entity object reference (i.e., `EJBObject`) to the client. If the `ejbFind<METHOD>` method returns a collection of primary keys, the implementation of the `find<METHOD>` method must create a collection of entity object references for the primary keys and return the collection to the client.

The implementation of each `<METHOD>` home method invokes a matching `ejbHome<METHOD>` method (in which the first character of `<METHOD>` is uppercased in the name of the `ejbHome<METHOD>` method), passing the `<METHOD>` parameters to the matching method.

10.3.3 Entity EJBObject Class

The entity EJBObject class, which is generated by deployment tools, implements the entity bean's remote interface. It implements the methods of the `javax.ejb.EJBObject` interface and the business methods specific to the entity bean.

The implementation of the `remove` method (defined in the `javax.ejb.EJBObject` interface) must activate an instance (if an instance is not already in the ready state) and invoke the `ejbRemove` method on the instance.

The implementation of each business method must activate an instance (if an instance is not already in the ready state) and invoke the matching business method on the instance.

10.3.4 Entity EJBLocalHome Class

The entity EJBLocalHome class, which is generated by deployment tools, implements the entity bean's local home interface. This class implements the methods of the `javax.ejb.EJBLocalHome` interface, and the type-specific create, finder, and home methods specific to the entity bean.

The implementation of each `create<METHOD>` method invokes a matching `ejbCreate<METHOD>` method, followed by the matching `ejbPostCreate<METHOD>` method, passing the `create<METHOD>` parameters to these matching methods.

The implementation of the `remove` method defined in the `javax.ejb.EJBLocalHome` interface must activate an instance (if an instance is not already in the ready state) and invoke the `ejbRemove` method on the instance.

The implementation of each `find<METHOD>` method invokes a matching `ejbFind<METHOD>` method. The implementation of the `find<METHOD>` method must create an entity object reference for the primary key returned from the `ejbFind<METHOD>` and return the entity object reference (i.e., `EJBLocalObject`) to the client. If the `ejbFind<METHOD>` method returns a collection of primary keys, the implementation of the `find<METHOD>` method must create a collection of entity object references for the primary keys and return the collection to the client.

The implementation of each `<METHOD>` home method invokes a matching `ejbHome<METHOD>` method (in which the first character of `<METHOD>` is uppercased in the name of the `ejbHome<METHOD>` method), passing the `<METHOD>` parameters to the matching method.

10.3.5 Entity EJBLocalObject Class

The entity `EJBLocalObject` class, which is generated by deployment tools, implements the entity bean's local interface. It implements the methods of the `javax.ejb.EJBLocalObject` interface and the business methods specific to the entity bean.

The implementation of the `remove` method (defined in the `javax.ejb.EJBLocalObject` interface) must activate an instance (if an instance is not already in the ready state) and invoke the `ejbRemove` method on the instance.

The implementation of each business method must activate an instance (if an instance is not already in the ready state) and invoke the matching business method on the instance.

10.3.6 Handle Class

The deployment tools are responsible for implementing the handle class for the entity bean. The handle class must be serializable by the Java Serialization protocol.

As the handle class is not entity-bean specific, the container may, but is not required to, use a single class for all deployed entity beans.

10.3.7 Home Handle Class

The deployment tools responsible for implementing the home handle class for the entity bean. The handle class must be serializable by the Java Serialization protocol.

Because the home handle class is not entity-bean specific, the container may, but is not required to, use a single class for the home handles of all deployed entity beans.

10.3.8 Metadata Class

The deployment tools are responsible for implementing the class that provides metadata information to the remote client view contract. The class must be a valid RMI-IIOP Value Type, and must implement the `javax.ejb.EJBMetaData` interface.

Because the metadata class is not entity-bean specific, the container may, but is not required to, use a single class for all deployed enterprise beans.

10.3.9 Instance's Re-entrance

The container runtime must enforce the rules defined in Section 10.1.14.

10.3.10 Transaction Scoping, Security, Exceptions

The container runtime must follow the rules on transaction scoping, security checking, and exception handling described in Chapters 13, 17, and 14.

10.3.11 Implementation of Object References

The container should implement the distribution protocol between the client and the container such that the object references of the remote home and remote interfaces used by entity bean clients are usable for a long period of time. Ideally, a client should be able to use an object reference across a server crash and restart. An object reference should become invalid only when the entity object has been removed, or after a reconfiguration of the server environment (for example, when the entity bean is moved to a different EJB server or container).

The motivation for this is to simplify the programming model for the entity bean client. While the client code needs to have a recovery handler for the system exceptions thrown from the individual method invocations on the home and remote interface, the client should not be forced to re-obtain the object references.

10.3.12 EntityContext

The container must implement the `EntityContext.getEJBObject` method such that the bean instance can use the Java language cast to convert the returned value to the entity bean's remote interface type. Specifically, the bean instance does not have to use the `PortableRemoteObject.narrow` method for the type conversion.

EJB 1.1 Entity Bean Component Contract for Container-Managed Persistence

This chapter specifies the EJB 1.1 entity bean component contract for container-managed persistence.

The EJB 1.1 Entity Bean Contract has been proposed for future removal. See Section 2.7 for more details.

11.1 EJB 1.1 Entity Beans with Container-Managed Persistence

Chapter 10, “EJB 2.1 Entity Bean Component Contract for Bean-Managed Persistence” describes the component contract for entity beans with bean-managed persistence. The contract for an EJB 1.1 entity bean with container-managed persistence is the same as the contract for an entity bean with bean-managed persistence as described in Chapter 10, except for the differences described in this chapter.

An EJB 1.1 entity bean with container-managed persistence cannot have a local interface or local home interface. Use of the local interfaces of other enterprise beans is not supported for an EJB 1.1 entity bean with container-managed persistence.

Use of the EJB Timer Service is not supported for an EJB 1.1 entity bean with container-managed persistence. An EJB 1.1 entity bean with container-managed persistence should not implement the `javax.ejb.TimedObject` interface. Use of dependency injection, interceptors, and any Java language metadata annotations is not supported for EJB 1.1 entity beans.

11.1.1 Container-Managed Fields

An EJB 1.1 entity bean with container-managed persistence relies on the Container Provider's tools to generate methods that perform data access on behalf of the entity bean instances. The generated methods transfer data between the entity bean instance's variables and the underlying resource manager at the times defined by the EJB specification. The generated methods also implement the creation, removal, and lookup of the entity object in the underlying database.

An entity bean with container-manager persistence must not code explicit data access—all data access must be deferred to the container.

The EJB 1.1 entity Bean Provider is responsible for using the `cmp-field` elements of the deployment descriptor to declare the instance's fields that the container must load and store at the defined times. The fields must be defined in the entity bean class as `public`, and must not be defined as `transient`.

The container is responsible for transferring data between the entity bean's instance variables and the underlying data source before or after the execution of the `ejbCreate`, `ejbRemove`, `ejbLoad`, and `ejbStore` methods, as described in the following subsections. The container is also responsible for the implementation of the finder methods.

The EJB 2.0 or later deployment descriptor for an EJB 1.1 entity bean with container-managed persistence indicates that the entity bean uses container-managed persistence and that the value of its `cmp-version` element is `1.x`.

The EJB 1.1 component contract does not architect support for relationships for entity beans with container-managed persistence. The EJB 2.0 and later specifications do not support the use of the `cmr-field`, `ejb-relation`, or `query` deployment descriptor elements or their subelements for EJB 1.1 entity beans.

The following requirements ensure that an EJB 1.1 entity bean with container-managed persistence can be deployed in any compliant container.

- The Bean Provider must ensure that the Java types assigned to the container-managed fields are restricted to the following: Java primitive types, Java serializable types, and references of enterprise beans' remote or remote home interfaces.
- The Container Provider may, but is not required to, use Java Serialization to store the container-managed fields in the database. If the container chooses a different approach, the effect should be equivalent to that of Java Serialization. The container must also be capable of persisting references to enterprise beans' remote and remote home interfaces (for example, by storing their handle or primary key).

Although the above requirements allow the Bean Provider to specify almost any arbitrary type for the container-managed fields, we expect that in practice the Bean Provider of EJB 1.1 entity beans with container-managed persistence will use relatively simple Java types, and that most containers will be able to map these simple Java types to columns in a database schema to externalize the entity state in the database, rather than use Java serialization.

If the Bean Provider expects that the container-managed fields will be mapped to database fields, he or she should provide mapping instructions to the Deployer. The mapping between the instance's container-managed fields and the schema of the underlying database manager will be then realized by the data access classes generated by the Container Provider's tools. Because entity beans are typically coarse-grained objects, the content of the container-managed fields may be stored in multiple rows, possibly spread across multiple database tables. These mapping techniques are beyond the scope of the EJB specification, and do not have to be supported by an EJB compliant container. (The container may simply use the Java serialization protocol in all cases).

11.1.2 ejbCreate, ejbPostCreate

With bean-managed persistence, the entity Bean Provider is responsible for writing the code that inserts a record into the database in the `ejbCreate` methods. However, with container-managed persistence, the container performs the database insert after the `ejbCreate` method completes.

The container must ensure that the values of the container-managed fields are set to the Java language defaults (e.g. 0 for integer, `null` for pointers) prior to invoking an `ejbCreate` method on an instance.

The EJB 1.1 entity Bean Provider's responsibility is to initialize the container-managed fields in the `ejbCreate` methods from the input arguments such that when an `ejbCreate` method returns, the container can extract the container-managed fields from the instance and insert them into the database.

The `ejbCreate` methods must be defined to return the primary key class type. The implementation of the `ejbCreate` methods should be coded to return a `null`. The returned value is ignored by the container.

Note: The above requirement is to allow the creation of an entity bean with bean-managed persistence by subclassing an EJB 1.1 entity bean with container-managed persistence. The Java language rules for overriding methods in subclasses requires the signatures of the `ejbCreate` methods in the subclass and the superclass be the same.

The container is responsible for creating the entity object's representation in the underlying database, extracting the primary key fields of the newly created entity object representation in the database, and for creating an entity `EJBObject` reference for the newly created entity object. The container must establish the primary key before it invokes the `ejbPostCreate` method. The container may create the representation of the entity in the database immediately after `ejbCreate` returns, or it can defer it to a later time (for example to the time after the matching `ejbPostCreate` has been called, or to the end of the transaction).

The container then invokes the matching `ejbPostCreate` method on the instance. The instance can discover the primary key by calling the `getPrimaryKey` method on its entity context object.

The container must invoke `ejbCreate`, perform the database insert operation, and invoke `ejbPostCreate` in the transaction context determined by the transaction attribute of the matching `create` method, as described in subsection 13.6.2.

The container throws the `DuplicateKeyException` if the newly created entity object would have the same primary key as one of the existing entity objects within the same home.

11.1.3 `ejbRemove`

The container invokes the `ejbRemove` method on an entity bean instance with container-managed persistence in response to a client-invoked `remove` operation on the entity bean's remote home or remote interface.

The entity Bean Provider can use the `ejbRemove` method to implement any actions that must be done before the entity object's representation is removed from the database.

The container synchronizes the instance's state before it invokes the `ejbRemove` method. This means that the state of the instance variables at the beginning of the `ejbRemove` method is the same as it would be at the beginning of a business method.

After `ejbRemove` returns, the container removes the entity object's representation from the database.

The container must perform `ejbRemove` and the database delete operation in the transaction context determined by the transaction attribute of the invoked `remove` method, as described in subsection 13.6.2.

11.1.4 `ejbLoad`

When the container needs to synchronize the state of an enterprise bean instance with the entity object's state in the database, the container reads the entity object's state from the database into the container-managed fields and then it invokes the `ejbLoad` method on the instance.

The entity Bean Provider can rely on the container's having loaded the container-managed fields from the database just before the container invokes the `ejbLoad` method. The entity bean can use the `ejbLoad` method, for instance, to perform some computation on the values of the fields that were read by the container (for example, uncompressing text fields).

11.1.5 `ejbStore`

When the container needs to synchronize the state of the entity object in the database with the state of the enterprise bean instance, the container first calls the `ejbStore` method on the instance, and then it extracts the container-managed fields and writes them to the database.

The entity Bean Provider should use the `ejbStore` method to set up the values of the container-managed fields just before the container writes them to the database. For example, the `ejbStore` method may perform compression of text before the text is stored in the database.

11.1.6 Finder Methods

The entity Bean Provider does not write the finder (`ejbFind<METHOD>`) methods.

The finder methods are generated at the entity bean deployment time using the Container Provider's tools. The tools can, for example, create a subclass of the entity bean class that implements the `ejbFind<METHOD>` methods, or the tools can generate the implementation of the finder methods directly in the class that implements the entity bean's remote home interface.

Note that the `ejbFind<METHOD>` names and parameter signatures of EJB 1.1 entity beans do not provide the container tools with sufficient information for automatically generating the implementation of the finder methods for methods other than `ejbFindByPrimaryKey`. Therefore, the Bean Provider is responsible for providing a description of each finder method. The entity bean Deployer uses container tools to generate the implementation of the finder methods based in the description supplied by the Bean Provider. The EJB 1.1 component contract for container-managed persistence does not specify the format of the finder method description.

11.1.7 Home Methods

The EJB 1.1 entity bean contract does not support `ejbHome` methods.

11.1.8 Create Methods

The EJB 1.1 entity bean contract does not support `create<METHOD>` methods.

11.1.9 Primary Key Type

The container must be able to manipulate the primary key type. Therefore, the primary key type for an entity bean with container-managed persistence must follow the rules in this subsection, in addition to those specified in Subsection 10.2.12.

There are two ways to specify a primary key class for an entity bean with container-managed persistence:

- Primary key that maps to a single field in the entity bean class.
- Primary key that maps to multiple fields in the entity bean class.

The second method is necessary for implementing compound keys, and the first method is convenient for single-field keys. Without the first method, simple types such as `String` would have to be wrapped in a user-defined class.

11.1.9.1 Primary Key that Maps to a Single Field in the Entity Bean Class

The Bean Provider uses the `primkey-field` element of the deployment descriptor to specify the container-managed field of the entity bean class that contains the primary key. The field's type must be the primary key type.

11.1.9.2 Primary Key that Maps to Multiple Fields in the Entity Bean Class

The primary key class must be `public`, and must have a `public` constructor with no parameters.

All fields in the primary key class must be declared as `public`.

The names of the fields in the primary key class must be a subset of the names of the container-managed fields. (This allows the container to extract the primary key fields from an instance's container-managed fields, and vice versa.)

11.1.9.3 Special Case: Unknown Primary Key Class

In special situations, the entity Bean Provider may choose not to specify the primary key class for an entity bean with container-managed persistence. This case usually happens when the entity bean does not have a natural primary key, and the Bean Provider wants to allow the Deployer to select the primary key fields at deployment time. The entity bean's primary key type will usually be derived from the primary key type used by the underlying database system that stores the entity objects. The primary key used by the database system may not be known to the Bean Provider.

When defining the primary key for the enterprise bean, the Deployer may sometimes need to subclass the entity bean class to add additional container-managed fields (this typically happens for entity beans that do not have a natural primary key, and the primary keys are system-generated by the underlying database system that stores the entity objects).

In this special case, the type of the argument of the `findByPrimaryKey` method must be declared as `java.lang.Object`, and the return value of `ejbCreate` must be declared as `java.lang.Object`. The Bean Provider must specify the primary key class in the deployment descriptor as of the type `java.lang.Object`.

The primary key class is specified at deployment time in the situations when the Bean Provider develops an entity bean that is intended to be used with multiple back-ends that provide persistence, and when these multiple back-ends require different primary key structures.

Use of entity beans with a deferred primary key type specification limits the client application programming model, because the clients written prior to deployment of the entity bean may not use, in general, the methods that rely on the knowledge of the primary key type.

The implementation of the enterprise bean class methods must be done carefully. For example, the methods should not depend on the type of the object returned from `EntityContext.getPrimaryKey`, because the return type is determined by the Deployer after the EJB class has been written.

Interceptors

Interceptors are used to interpose on business method invocations and lifecycle events that occur on an enterprise bean instance.

12.1 Overview

The general rules for defining Interceptor classes, their lifecycle, and associated metadata are described in a separate Interceptors document. This chapter describes the set of requirements that are specific to the use of Interceptors with Enterprise JavaBeans.

For the use of interceptors with Enterprise JavaBeans, the Interceptor “target class” is the bean class. Interceptors may be used with session beans and message-driven beans.

The programming restrictions that apply to enterprise bean components apply to interceptors as well. See Section 21.2.2

Default interceptors may be defined to apply to all components within an ejb-jar file or .war file.

12.2 Interceptor Life Cycle

The lifecycle of an interceptor instance is the same as that of the bean instance with which it is associated. In the case of interceptors associated with stateful session beans, the interceptor instances are passivated upon bean instance passivation, and activated when the bean instance is activated. See sections 4.6, 4.7.1, and 5.5.

In addition to the `PostConstruct` and `PreDestroy` callback support required by the Interceptors specification, interceptors associated with Stateful Session Beans may define `PostActivate` and `PrePassivate` callbacks. Both the interceptor instance and the bean instance are created or activated before any of the respective `PostConstruct` or `PostActivate` callbacks are invoked. Any `PreDestroy` and `PrePassivate` callbacks are invoked before the respective destruction or passivation of either the bean instance or interceptor instance.

The use of an extended persistence context is only supported for interceptors that are associated with stateful session beans.

12.3 Business Method Interceptors

Interceptor methods may be defined for business methods of sessions beans and for the message listener methods of message-driven beans.

12.3.1 Exceptions

Business method interceptor methods may throw runtime exceptions or application exceptions that are allowed in the `throws` clause of the business method.

`AroundInvoke` methods are allowed to catch and suppress exceptions and recover by calling `proceed()`. `AroundInvoke` methods are allowed to throw runtime exceptions or any checked exceptions that the business method allows within its `throws` clause.

`AroundInvoke` methods can mark the transaction for rollback by throwing a runtime exception or by calling the `EJBContext` `setRollbackOnly()` method. `AroundInvoke` methods may cause this rollback before or after `InvocationContext.proceed()` is called.

If a system exception escapes the interceptor chain the bean instance and any associated interceptor instances are discarded.^[58] The `PreDestroy` callbacks are not invoked in this case: the interceptor methods in the chain should perform any necessary clean-up operations as the interceptor chain unwinds.

[58] Except for singletons. See Section 4.8.4

12.4 Timer Timeout Method Interceptors

Interceptor methods may be defined for EJB timer timeout methods of session beans and message-driven beans. These are referred to as `AroundTimeout` methods.

Within an `AroundTimeout` method, the `InvocationContext.getTimer()` method returns the `javax.ejb.Timer` object associated with the timeout being intercepted.

12.4.1 Exceptions

`AroundTimeout` methods may throw system exceptions, but not application exceptions.

12.5 Interceptors for LifeCycle Event Callbacks

Lifecycle callback interceptor methods may be defined for session beans and message driven beans.

Interceptor methods for lifecycle event callbacks can be defined on an interceptor class and/or directly on the bean class. The `PostConstruct`, `PreDestroy`, `PostActivate`, and `PrePassivate` annotations are used to define an interceptor method for a lifecycle callback event..

Lifecycle callback interceptor methods are invoked in an unspecified security context. Lifecycle callback interceptor methods are invoked in an unspecified transaction context, except for `Singleton PostConstruct / PreDestroy` methods, whose transaction context is based on their associated `tx` attribute. See Section 4.3.4.

12.5.1 Exceptions

Lifecycle callback interceptor methods may throw system runtime exceptions, but not application exceptions.

A runtime exception thrown by any lifecycle interceptor callback method causes the bean instance and its interceptors to be discarded^[59] after the interceptor chain unwinds.

The `PreDestroy` callbacks are not invoked when the bean and the interceptors are discarded as a result of such exceptions: the lifecycle callback interceptor methods in the chain should perform any necessary clean-up operations as the interceptor chain unwinds.

[59] Except for Singletons. See Section 4.8.4

12.6 InvocationContext

The `InvocationContext` object provides metadata that enables interceptor methods to control the behavior of the invocation chain. The contextual data is not sharable across separate business method invocations or lifecycle callback events. If interceptors are invoked as a result of the invocation on a web service endpoint, the map returned by `getContextData` will be the JAX-WS `MessageContext` [32]. The lifecycle of the `InvocationContext` instance is otherwise unspecified.

12.7 Specification of Interceptors in the Deployment Descriptor

The deployment descriptor can be used as an alternative to metadata annotations to specify interceptors and their binding to enterprise beans or to override the invocation order of interceptors as specified in annotations. See the Interceptors specification for a definition of the interceptor deployment descriptor elements.

The `pre-passivate` and `post-activate` methods are specified using the `pre-passivate` and `post-activate` elements.

In the `interceptor-binding` element, the `target-name` element must be the name of one of the enterprise beans contained in the `ejb-jar` or the wildcard value `"*"`.

Default interceptors may be declared in the `ejb-jar.xml` file. Default interceptors apply to all enterprise beans in the containing module.

Support for Transactions

One of the key features of the Enterprise JavaBeans™ architecture is support for distributed transactions. The Enterprise JavaBeans architecture allows an application developer to write an application that atomically updates data in multiple databases which may be distributed across multiple sites. The sites may use EJB servers from different vendors.

13.1 Overview

This section provides a brief overview of transactions and illustrates a number of transaction scenarios in EJB.

13.1.1 Transactions

Transactions are a proven technique for simplifying application programming. Transactions free the application programmer from dealing with the complex issues of failure recovery and multi-user programming. If the application programmer uses transactions, the programmer divides the application's work into units called transactions. The transactional system ensures that a unit of work either fully completes, or the work is fully rolled back. Furthermore, transactions make it possible for the programmer to design the application as if it ran in an environment that executes units of work serially.

Support for transactions is an essential element of the Enterprise JavaBeans architecture. The Enterprise Bean Provider and the client application programmer are not exposed to the complexity of distributed transactions. The Bean Provider can choose between using programmatic transaction demarcation in the enterprise bean code (this style is called *bean-managed transaction demarcation*) or declarative transaction demarcation performed automatically by the EJB container (this style is called *container-managed transaction demarcation*).

With bean-managed transaction demarcation, the enterprise bean code demarcates transactions using the `javax.transaction.UserTransaction` interface. All resource manager accesses between the `UserTransaction.begin` and `UserTransaction.commit` calls are part of a transaction.

The terms resource and resource manager used in this chapter refer to the resources declared using the Resource annotation in the enterprise bean class or using the resource-ref element in the enterprise bean's deployment descriptor. This includes not only database resources, but also other resources, such as JMS Connections. These resources are considered to be "managed" by the container.^[60]

With container-managed transaction demarcation, the container demarcates transactions per instructions provided by the developer in metadata annotations or in the deployment descriptor. These instructions, called *transaction attributes*, tell the container whether it should include the work performed by an enterprise bean method in a client's transaction, run the enterprise bean method in a new transaction started by the container, or run the method with "no transaction" (Refer to Subsection 13.6.5 for the description of the "no transaction" case).

Regardless of whether an enterprise bean uses bean-managed or container-managed transaction demarcation, the burden of implementing transaction management is on the EJB container and server provider. The EJB container and server implement the necessary low-level transaction protocols, such as the two-phase commit protocol between a transaction manager and a database system or messaging provider, transaction context propagation, and distributed two-phase commit.

Many applications will consist of one or several enterprise beans that all use a single resource manager (typically a relational database management system). The EJB container can make use of resource manager local transactions as an optimization technique for enterprise beans for which distributed transactions are not needed. A resource manager local transaction does not involve control or coordination by an external transaction manager. The container's use of local transactions as an optimization technique for enterprise beans with either container-managed transaction demarcation or bean-managed transaction demarcation is not visible to the enterprise beans. For a discussion of the use of resource manager local transactions as a container optimization strategy, refer to [12] and [15].

13.1.2 Transaction Model

The Enterprise JavaBeans architecture supports flat transactions. A flat transaction cannot have any child (nested) transactions.

[60] Note that environment entries other than resources are specified with the `Resource` annotation and/or `resource-ref` deployment descriptor element as well.

Note: The decision not to support nested transactions allows vendors of existing transaction processing and database management systems to incorporate support for Enterprise JavaBeans. If these vendors provide support for nested transactions in the future, Enterprise JavaBeans may be enhanced to take advantage of nested transactions.

13.1.3 Relationship to JTA and JTS

The Java™ Transaction API (JTA) [8] is a specification of the interfaces between a transaction manager and the other parties involved in a distributed transaction processing system: the application programs, the resource managers, and the application server.

The Java Transaction Service (JTS) [9] API is a Java binding of the CORBA Object Transaction Service (OTS) 1.1 specification. JTS provides transaction interoperability using the standard IIOP protocol for transaction propagation between servers. The JTS API is intended for vendors who implement transaction processing infrastructure for enterprise middleware. For example, an EJB server vendor may use a JTS implementation as the underlying transaction manager.

The EJB architecture does not require the EJB container to support the JTS interfaces. The EJB architecture requires that the EJB container support the JTA API defined in [8] and the Connector APIs defined in [15].

13.2 Sample Scenarios

This section describes several scenarios that illustrate the distributed transaction capabilities of the Enterprise JavaBeans architecture.

13.2.1 Update of Multiple Databases

The Enterprise JavaBeans architecture makes it possible for an application program to update data in multiple databases in a single transaction.

In the following figure, a client invokes the enterprise bean X. Bean X updates data using two database connections that the Deployer configured to connect with two different databases, A and B. Then X calls another enterprise bean, Y. Bean Y updates data in database C. The EJB server ensures that the updates to databases A, B, and C are either all committed or all rolled back.

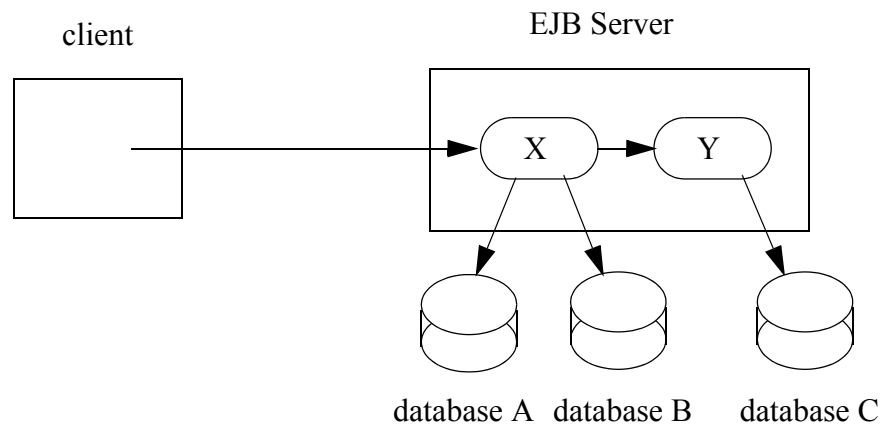
Figure 24 Updates to Simultaneous Databases

The application programmer does not have to do anything to ensure transactional semantics. Behind the scenes, the EJB server enlists the database connections as part of the transaction. When the transaction commits, the EJB server and the database systems perform a two-phase commit protocol to ensure atomic updates across all three databases.

13.2.2 Messages Sent or Received Over JMS Sessions and Update of Multiple Databases

The Enterprise JavaBeans architecture makes it possible for an application program to send messages to or receive messages from one or more JMS Destinations and/or to update data in one or more databases in a single transaction.

In the following figure, a client invokes the enterprise bean X. Bean X sends a message to a JMS queue A and updates data in a database B using connections that the Deployer configured to connect with a JMS provider and a database. Then X calls another enterprise bean, Y. Bean Y updates data in database C. The EJB server ensures that the operations on A, B, and C are either all committed, or all rolled back.

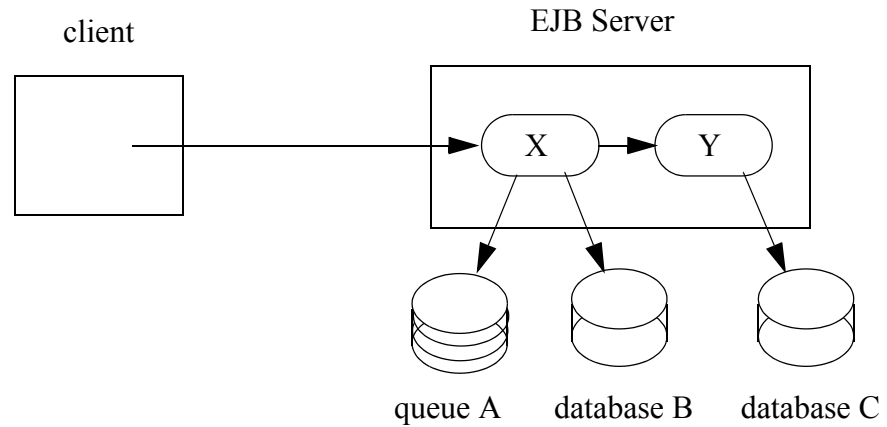
Figure 25 Message Sent to JMS Queue and Updates to Multiple Databases

The application programmer does not have to do anything to ensure transactional semantics. The enterprise beans X and Y perform the message send and database updates using the standard JMS and JDBC™ APIs. Behind the scenes, the EJB server enlists the session on the connection to the JMS provider and the database connections as part of the transaction. When the transaction commits, the EJB server and the messaging and database systems perform a two-phase commit protocol to ensure atomic updates across all the three resources.

In the following figure, a client sends a message to the JMS queue A serviced by the message-driven bean X. Bean X updates data using two database connections that the deployer configured to connect with two different databases, B and C. The EJB server ensures that the dequeuing of the JMS message, its receipt by bean X, and the updates to databases B and C are either all committed or all rolled back.

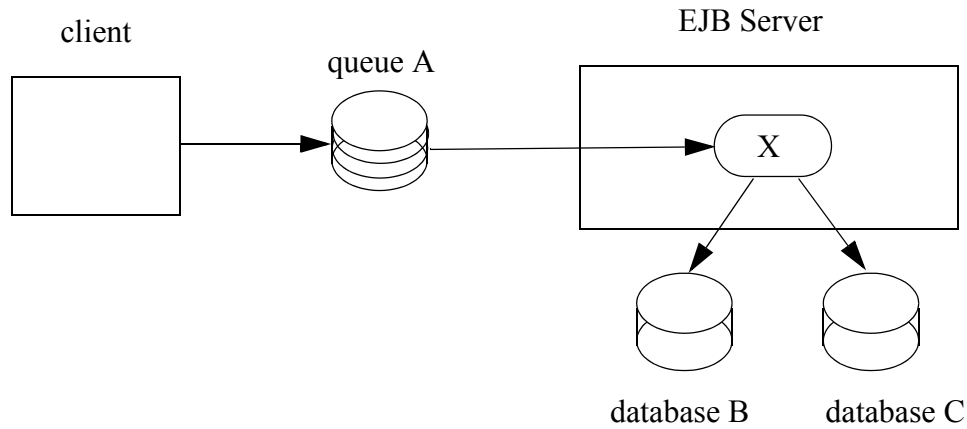
Figure 26 Message Sent to JMS Queue Serviced by Message-Driven Bean and Updates to Multiple Databases

13.2.3 Update of Databases via Multiple EJB Servers

The Enterprise JavaBeans architecture allows updates of data at multiple sites to be performed in a single transaction.

In the following figure, a client invokes the enterprise bean X. Bean X updates data in database A, and then calls another enterprise bean Y that is installed in a remote EJB server. Bean Y updates data in database B. The Enterprise JavaBeans architecture makes it possible to perform the updates to databases A and B in a single transaction.

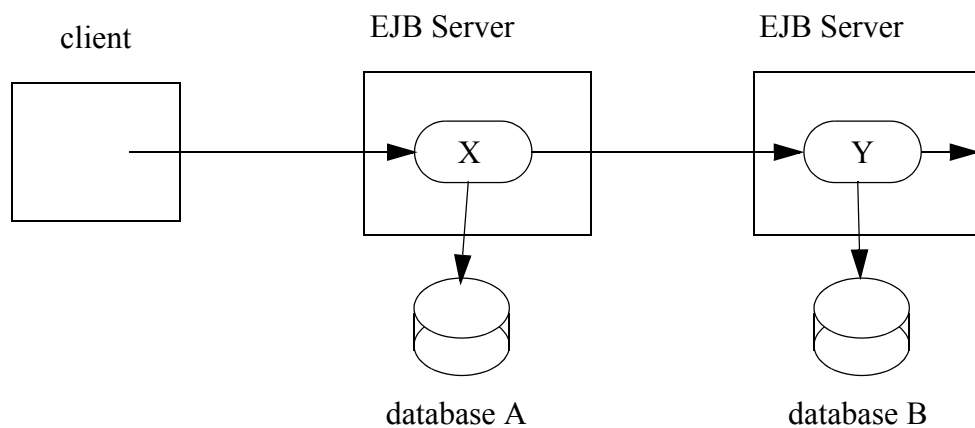
Figure 27 Updates to Multiple Databases in Same Transaction

When X invokes Y, the two EJB servers cooperate to propagate the transaction context from X to Y. This transaction context propagation is transparent to the application-level code.

At transaction commit time, the two EJB servers use a distributed two-phase commit protocol (if the capability exists) to ensure the atomicity of the database updates.

13.2.4 Client-Managed Demarcation

A Java client can use the `javax.transaction.UserTransaction` interface to explicitly demarcate transaction boundaries. The client program obtains the `javax.transaction.UserTransaction` interface through dependency injection or lookup in the bean's `EJBContext` or in the JNDI name space.

A client program using explicit transaction demarcation may perform, via enterprise beans, atomic updates across multiple databases residing at multiple EJB servers, as illustrated in the following figure.

Figure 28 Updates on Multiple Databases on Multiple Servers

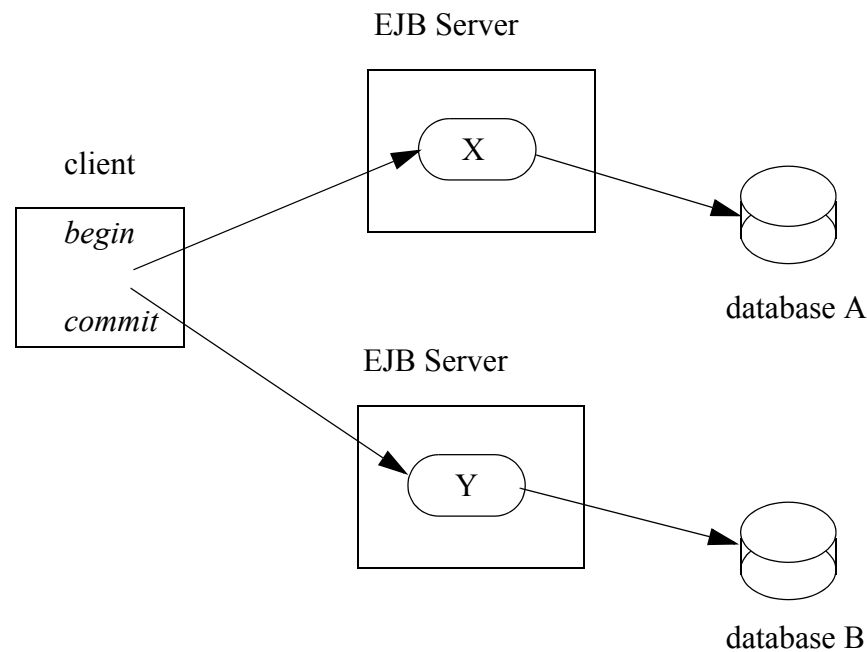

The application programmer demarcates the transaction with `begin` and `commit` calls. If the enterprise beans X and Y are configured to use a client transaction (i.e., their methods have transaction attributes that either require or support an existing transaction context), the EJB server ensures that the updates to databases A and B are made as part of the client's transaction.

13.2.5 Container-Managed Demarcation

Whenever a client invokes a method on an enterprise bean's business interface (or on the no-interface view or home or component interface of an enterprise bean), the container interposes on the method invocation. The interposition allows the container to control transaction demarcation declaratively through the transaction attribute set by the developer. (See Section 13.3.7 for a description of transaction attributes.)

For example, if an enterprise bean method is configured with the `REQUIRED` transaction attribute, the container behaves as follows: If the client request is not associated with a transaction context, the container automatically initiates a transaction whenever a client invokes an enterprise bean method that requires a transaction context. If the client request contains a transaction context, the container includes the enterprise bean method in the client transaction.

*The following figure illustrates such a scenario. A non-transactional client invokes the enterprise bean *X*, and the invoked method has the `REQUIRED`^[61] transaction attribute. Because the message from the client does not include a transaction context, the container starts a new transaction before dispatching the method on *X*. Bean *X*'s work is performed in the context of the transaction. When *X* calls other enterprise beans (*Y* in our example), the work performed by the other enterprise beans is also automatically included in the transaction (subject to the transaction attribute of the other enterprise bean).*

Figure 29 Update of Multiple Databases from Non-Transactional Client

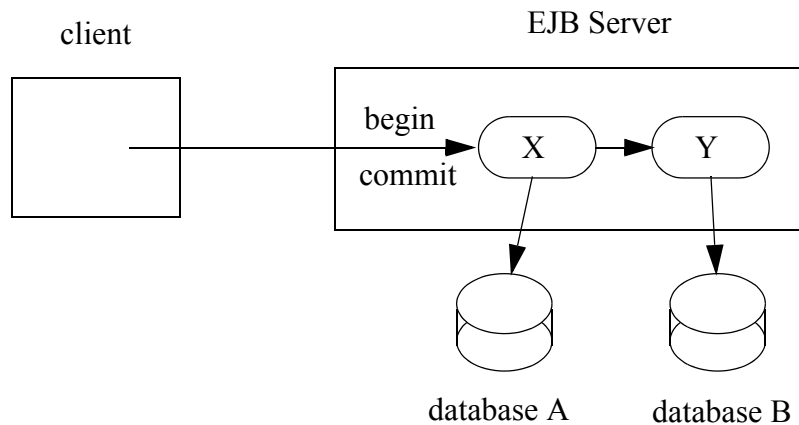

*The container automatically commits the transaction at the time *X* returns a reply to the client.*

If a message-driven bean's message listener method is configured with the `REQUIRED` transaction attribute, the container automatically starts a new transaction before the delivery of the message and, hence, before the invocation of the method.^[62]

[61] In this chapter we use the `TransactionAttribute` annotation values to refer to transaction attributes. The deployment descriptor may be used as an overriding mechanism or an alternative to the use of annotations, and must be used for EJB 2.1 and 1.1 entity beans, for which the use of annotations is not supported.

JMS requires that the transaction be started before the dequeuing of the message. See [13].

The container automatically enlists the resource manager associated with the arriving message and all the resource managers accessed by the message listener method with the transaction.

13.3 Bean Provider's Responsibilities

This section describes the Bean Provider's view of transactions and defines the Bean Provider's responsibilities.

13.3.1 Bean-Managed Versus Container-Managed Transaction Demarcation

When designing an enterprise bean, the developer must decide whether the enterprise bean will demarcate transactions programmatically in the business methods (bean-managed transaction demarcation), or whether the transaction demarcation is to be performed by the container based on the transaction attributes specified in metadata annotations or in the deployment descriptor (container-managed transaction demarcation). Typically enterprise beans will be specified to have container-managed transaction demarcation. This is the default if no transaction management type is specified.

A session bean or a message-driven bean can be designed with bean-managed transaction demarcation or with container-managed transaction demarcation. (But it cannot be both at the same time.)

An EJB 2.1 or EJB 1.1 entity bean must always use container-managed transaction demarcation. An EJB 2.1 or EJB 1.1 entity bean must not be designated with bean-managed transaction demarcation.

A transaction management type cannot be specified for Java Persistence entities. Java Persistence entities execute within the transactional context of the caller. See the "*Java Persistence API*" specification [2] for a discussion of transactions involving Java Persistence entities.

An enterprise bean instance can access resource managers in a transaction only in the enterprise bean's methods in which there is a transaction context available.

13.3.1.1 Non-Transactional Execution

Some enterprise beans may need to access resource managers that do not support an external transaction coordinator. The container cannot manage the transactions for such enterprise beans in the same way that it can for the enterprise beans that access resource managers that support an external transaction coordinator.

If an enterprise bean needs to access a resource manager that does not support an external transaction coordinator, the Bean Provider should design the enterprise bean with container-managed transaction demarcation and assign the `NOT_SUPPORTED` transaction attribute to the bean class or to all the bean's methods. The EJB architecture does not specify the transactional semantics of the enterprise bean methods. See Subsection 13.6.5 for how the container implements this case.

[62] We use the term "container" here to encompass both the container and the messaging provider. When the contracts outlined in [15] are used, it may be the messaging provider that starts the transaction.

13.3.2 Isolation Levels

Transactions not only make completion of a unit of work atomic, but they also isolate the units of work from each other, provided that the system allows concurrent execution of multiple units of work.

The *isolation level* describes the degree to which the access to a resource manager by a transaction is isolated from the access to the resource manager by other concurrently executing transactions.

The following are guidelines for managing isolation levels in enterprise beans.

- The API for managing an isolation level is resource-manager-specific. (Therefore, the EJB architecture does not define an API for managing isolation levels.)
- If an enterprise bean uses multiple resource managers, the Bean Provider may specify the same or different isolation level for each resource manager. This means, for example, that if an enterprise bean accesses multiple resource managers in a transaction, access to each resource manager may be associated with a different isolation level.
- The Bean Provider must take care when setting an isolation level. Most resource managers require that all accesses to the resource manager within a transaction are done with the same isolation level. An attempt to change the isolation level in the middle of a transaction may cause undesirable behavior, such as an implicit sync point (a commit of the changes done so far).
- For session beans and message-driven beans with bean-managed transaction demarcation, the Bean Provider can specify the desirable isolation level programmatically in the enterprise bean's methods, using the resource-manager specific API. For example, the Bean Provider can use the `java.sql.Connection.setTransactionIsolation` method to set the appropriate isolation level for database access.
- The container provider should insure that suitable isolation levels are provided to guarantee data consistency for EJB 2.1 and 2.0 entity beans. Typically this means that an equivalent of a repeatable read or serializable isolation level should be available for applications that require a high degree of isolation.
- For entity beans with EJB 2.1 container-managed persistence and earlier, transaction isolation is managed by the data access classes that are generated by the container provider's tools. The tools must ensure that the management of the isolation levels performed by the data access classes will not result in conflicting isolation level requests for a resource manager within a transaction.
- Additional care must be taken if multiple enterprise beans access the same resource manager in the same transaction. Conflicts in the requested isolation levels must be avoided.

13.3.3 Enterprise Beans Using Bean-Managed Transaction Demarcation

This subsection describes the requirements for the Bean Provider of an enterprise bean with bean-managed transaction demarcation.

The enterprise bean with bean-managed transaction demarcation must be a session bean or a message-driven bean.

An instance that starts a transaction must complete the transaction before it starts a new transaction.

The Bean Provider uses the `UserTransaction` interface to demarcate transactions. All updates to the resource managers between the `UserTransaction.begin` and `UserTransaction.commit` methods are performed in a transaction. While an instance is in a transaction, the instance must not attempt to use the resource-manager specific transaction demarcation API (e.g. it must not invoke the `commit` or `rollback` method on the `java.sql.Connection` interface or on the `javax.jms.Session` interface).^[63]

A stateful session bean instance may, but is not required to, commit a started transaction before a business method returns. If a transaction has not been completed by the end of a business method, the container retains the association between the transaction and the instance across multiple client calls until the instance eventually completes the transaction.

A stateless session bean instance must commit a transaction before a business method or timeout callback method returns.

A singleton session bean instance must commit a transaction before a business method or timeout callback method or `PostConstruct/PreDestroy` lifecycle callback interceptor method returns.

A message-driven bean instance must commit a transaction before a message listener method or timeout callback method returns.

[63] However, use of the Java Persistence API `EntityTransaction` interface is supported. See [2] for a description of the `EntityTransaction` interface and its use.

The following example illustrates a business method that performs a transaction involving two database connections.

```
@Stateless
@TransactionManagement(BEAN)
public class MySessionBean implements MySession {
    @Resource javax.transaction.UserTransaction ut;
    @Resource javax.sql.DataSource database1;
    @Resource javax.sql.DataSource database2;

    public void someMethod(...) {
        java.sql.Connection con1;
        java.sql.Connection con2;
        java.sql.Statement stmt1;
        java.sql.Statement stmt2;

        // obtain con1 object and set it up for transactions
        con1 = database1.getConnection();

        stmt1 = con1.createStatement();

        // obtain con2 object and set it up for transactions
        con2 = database2.getConnection();

        stmt2 = con2.createStatement();

        //
        // Now do a transaction that involves con1 and con2.
        //
        // start the transaction
        ut.begin();

        // Do some updates to both con1 and con2. The container
        // automatically enlists con1 and con2 with the transaction.
        stmt1.executeQuery(...);
        stmt1.executeUpdate(...);
        stmt2.executeQuery(...);
        stmt2.executeUpdate(...);
        stmt1.executeUpdate(...);
        stmt2.executeUpdate(...);

        // commit the transaction
        ut.commit();

        // release connections
        stmt1.close();
        stmt2.close();
        con1.close();
        con2.close();
    }
    ...
}
```

The following example illustrates a business method that performs a transaction involving both a database connection and a JMS connection.

```
@Stateless
@TransactionManagement(BEAN)
public class MySessionBean implements MySession {
    @Resource javax.Transaction.UserTransaction ut;
    @Resource javax.sql.DataSource databasel;
    @Resource javax.jms.QueueConnectionFactory qcfl;
    @Resource javax.jms.Queue queue1;

    public void someMethod(...) {
        java.sql.Connection dcon;
        java.sql.Statement stmt;
        javax.jms.QueueConnection qcon;
        javax.jms.QueueSession qsession;
        javax.jms.QueueSender qsender;
        javax.jms.Message message;

        // obtain db conn object and set it up for transactions

        dcon = databasel.getConnection();

        stmt = dcon.createStatement();

        // obtain jms conn object and set up session for transactions
        qcon = qcfl.createQueueConnection();
        qsession = qcon.createQueueSession(true,0);
        qsender = qsession.createSender(queue1);
        message = qsession.createTextMessage();
        message.setText("some message");

        //
        // Now do a transaction that involves the two connections.
        //
        // start the transaction
        ut.begin();

        // Do database updates and send message. The container
        // automatically enlists dcon and qsession with the
        // transaction.
        stmt.executeQuery(...);
        stmt.executeUpdate(...);
        stmt.executeUpdate(...);
        qsender.send(message);

        // commit the transaction
        ut.commit();

        // release connections
        stmt.close();
        qsender.close();
        qsession.close();
        dcon.close();
        qcon.close();
    }
    ...
}
```

The following example illustrates a stateful session bean that retains a transaction across three client calls, invoked in the following order: `method1`, `method2`, and `method3`.^[64]

```
@Stateful
@TransactionManagement(BEAN)
public class MySessionBean implements MySession {
    @Resource javax.Transaction.UserTransaction ut;
    @Resource javax.sql.DataSource database1;
    @Resource javax.sql.DataSource database2;
    java.sql.Connection con1;
    java.sql.Connection con2;

    public void method1(...) {
        java.sql.Statement stmt;

        // start a transaction
        ut.begin();

        // make some updates on con1
        con1 = database1.getConnection();
        stmt = con1.createStatement();
        stmt.executeUpdate(...);
        stmt.executeUpdate(...);

        //
        // The container retains the transaction associated with the
        // instance to the next client call (which is method2(...)).
    }

    public void method2(...) {
        java.sql.Statement stmt;

        con2 = database2.getConnection();
        stmt = con2.createStatement();
        stmt.executeUpdate(...);
        stmt.executeUpdate(...);

        // The container retains the transaction associated with the
        // instance to the next client call (which is method3(...)).
    }

    public void method3(...) {
        java.sql.Statement stmt;

        // make some more updates on con1 and con2
        stmt = con1.createStatement();
        stmt.executeUpdate(...);
        stmt = con2.createStatement();
        stmt.executeUpdate(...);

        // commit the transaction
        ut.commit();

        // release connections
        stmt.close();
    }
}
```

[64] Note that the Bean Provider must use the pre-passivation callback method here to close the connections and set the instance variables for the connection to null.

```
        con1.close();
        con2.close();
    }
    ...
}
```

It is possible for an enterprise bean to open and close a database connection in each business method (rather than hold the connection open until the end of transaction). In the following example, if the client executes the sequence of methods (method1, method2, method2, method2, and method3), all the database updates done by the multiple invocations of method2 are performed in the scope of the same transaction, which is the transaction started in method1 and committed in method3.

```
@Stateful
@TransactionManagement(BEAN)
public class MySessionBean implements MySession {
    @Resource javax.Transaction.UserTransaction ut;
    @Resource javax.sql.DataSource database1;

    public void method1(...) {
        // start a transaction
        ut.begin();
    }

    public void method2(...) {
        java.sql.Connection con;
        java.sql.Statement stmt;

        // open connection
        con = database1.getConnection();

        // make some updates on con
        stmt = con.createStatement();
        stmt.executeUpdate(...);
        stmt.executeUpdate(...);

        // close the connection
        stmt.close();
        con.close();
    }

    public void method3(...) {

        // commit the transaction
        ut.commit();
    }
    ...
}
```

13.3.3.1 getRollbackOnly and setRollbackOnly Methods

An enterprise bean with bean-managed transaction demarcation must not use the `getRollbackOnly` and `setRollbackOnly` methods of the `EJBContext` interface.

An enterprise bean with bean-managed transaction demarcation has no need to use these methods, because of the following reasons:

- An enterprise bean with bean-managed transaction demarcation can obtain the status of a transaction by using the `getStatus` method of the `javax.transaction.UserTransaction` interface.
- An enterprise bean with bean-managed transaction demarcation can rollback a transaction using the `rollback` method of the `javax.transaction.UserTransaction` interface.

13.3.4 Enterprise Beans Using Container-Managed Transaction Demarcation

This subsection describes the requirements for the Bean Provider of an enterprise bean using container-managed transaction demarcation.

The enterprise bean's business methods, message listener methods, business method interceptor methods, lifecycle callback interceptor methods, or timeout callback methods must not use any resource-manager specific transaction management methods that would interfere with the container's demarcation of transaction boundaries. For example, the enterprise bean methods must not use the following methods of the `java.sql.Connection` interface: `commit`, `setAutoCommit`, and `rollback`; or the following methods of the `javax.jms.Session` interface: `commit` and `rollback`.

The enterprise bean's business methods, message listener methods, business method interceptor methods, lifecycle callback interceptor methods, or timeout callback methods must not attempt to obtain or use the `javax.transaction.UserTransaction` interface.

The following is an example of a business method in an enterprise bean with container-managed transaction demarcation. The business method updates two databases using JDBC™ connections. The container provides transaction demarcation as specified by the transaction attribute.^[65]

```
@Stateless public class MySessionBean implements MySession {
    ...

    @TransactionAttribute(REQUIRED)
    public void someMethod(...) {
        java.sql.Connection con1;
        java.sql.Connection con2;
        java.sql.Statement stmt1;
        java.sql.Statement stmt2;

        // obtain con1 and con2 connection objects
        con1 = ...;
        con2 = ...;

        stmt1 = con1.createStatement();
        stmt2 = con2.createStatement();

        //
        // Perform some updates on con1 and con2. The container
        // automatically enlists con1 and con2 with the container-
        // managed transaction.
        //
        stmt1.executeQuery(...);
        stmt1.executeUpdate(...);

        stmt2.executeQuery(...);
        stmt2.executeUpdate(...);

        stmt1.executeUpdate(...);
        stmt2.executeUpdate(...);

        // release connections
        con1.close();
        con2.close();
    }
    ...
}
```

13.3.4.1 javax.ejb.SessionSynchronization Interface

A stateful session bean with container-managed transaction demarcation can optionally implement the `javax.ejb.SessionSynchronization` interface or use the session synchronization annotations. Their use is described in Subsection 4.3.7.

[65] REQUIRED is the default transaction attribute value for container managed transaction demarcation. The explicit specification of the transaction attribute is therefore not required in this example.

13.3.4.2 `javax.ejb.EJBContext.setRollbackOnly` Method

An enterprise bean with container-managed transaction demarcation can use the `setRollbackOnly` method of its `EJBContext` object to mark the transaction such that the transaction can never commit. Typically, an enterprise bean marks a transaction for rollback to protect data integrity before throwing an application exception, if the application exception class has not been specified to automatically cause the container to rollback the transaction.

For example, an `AccountTransfer` bean which debits one account and credits another account could mark a transaction for rollback if it successfully performs the debit operation, but encounters a failure during the credit operation.

13.3.4.3 `javax.ejb.EJBContext.getRollbackOnly` method

An enterprise bean with container-managed transaction demarcation can use the `getRollbackOnly` method of its `EJBContext` object to test if the current transaction has been marked for rollback. The transaction might have been marked for rollback by the enterprise bean itself, by other enterprise beans, or by other components (outside of the EJB specification scope) of the transaction processing infrastructure.

13.3.5 Use of JMS APIs in Transactions

The Bean Provider should not make use of the JMS request/reply paradigm (sending of a JMS message, followed by the synchronous receipt of a reply to that message) within a single transaction. Because a JMS message is typically not delivered to its final destination until the transaction commits, the receipt of the reply within the same transaction will not take place.

Because the container manages the transactional enlistment of JMS sessions on behalf of a bean, the parameters of the `createSession(boolean transacted, int acknowledgeMode)`, `createQueueSession(boolean transacted, int acknowledgeMode)` and `createTopicSession(boolean transacted, int acknowledgeMode)` methods are ignored. It is recommended that the Bean Provider specify that a session is transacted, but provide 0 for the value of the acknowledgment mode.

The Bean Provider should not use the JMS `acknowledge` method either within a transaction or within an unspecified transaction context. Message acknowledgment in an unspecified transaction context is handled by the container. Section 13.6.5 describes some of the techniques that the container can use for the implementation of a method invocation with an unspecified transaction context.

13.3.6 Specification of a Bean's Transaction Management Type

By default, a session bean or message-driven bean has container managed transaction demarcation if the transaction management type is not specified. The Bean Provider of a session bean or a message-driven bean can use the `TransactionManagement` annotation to declare whether the session bean or message-driven bean uses bean-managed or container-managed transaction demarcation. The value of the `TransactionManagement` annotation is either `CONTAINER` or `BEAN`. The `TransactionManagement` annotation is applied to the enterprise bean class.

Alternatively, the Bean Provider can use the `transaction-type` deployment descriptor element to specify the bean's transaction management type. If the deployment descriptor is used, it is only necessary to explicitly specify the bean's transaction management type if bean-managed transaction is used.

The transaction management type of a bean is determined by the Bean Provider. The application assembler is not permitted to use the deployment descriptor to override a bean's transaction management type regardless of whether it has been explicitly specified or defaulted by the Bean Provider. (See Chapter 19 for information about the deployment descriptor.)

13.3.7 Specification of the Transaction Attributes for a Bean's Methods

The Bean Provider of an enterprise bean with container-managed transaction demarcation may specify the transaction attributes for the enterprise bean's methods. By default, the value of the transaction attribute for a method of a bean with container-managed transaction demarcation is the `REQUIRED` transaction attribute, and the transaction attribute does not need to be explicitly specified in this case.

A transaction attribute is a value associated with each of the following methods

- a method of a bean's business interface
- a method exposed through the bean class no-interface view
- a message listener method of a message-driven bean
- a timeout callback method
- a session bean's web service endpoint method
- for beans written to the EJB 2.1 and earlier client view, a method of a session or entity bean's home or component interface
- a singleton session bean's `PostConstruct/PreDestroy` lifecycle callback interceptor methods

The transaction attribute specifies how the container must manage transactions for a method when a client invokes the method.

Transaction attributes are specified for the following methods:

- For a session bean written to the EJB 3.x client view API, the transaction attributes are specified for those methods of the session bean class that correspond to the bean's business interface, the direct and indirect superinterfaces of the business interface, methods exposed through the bean class no-interface view, and for the timeout callback methods, if any.
- For a stateless session bean or singleton session bean that provides a web service client view, the transaction attributes are specified for the bean's web service endpoint methods, and for the timeout callback methods, if any.

- For a singleton session bean the `PostConstruct/PreDestroy` lifecycle callback interceptor methods, if any. In order to specify the transaction attribute for a `PostConstruct/PreDestroy` method of a singleton session bean, the transaction attribute must be specified for the method(s) on the bean class, rather than for a superclass or `PostConstruct/PreDestroy` interceptor method.
- For a message-driven bean, the transaction attributes are specified for those methods on the message-driven bean class that correspond to the bean's message listener interface and for the timeout callback methods, if any.
- For a session bean written to the EJB 2.1 and earlier client view, the transaction attributes are specified for the methods of the component interface and all the direct and indirect superinterfaces of the component interface, excluding the methods of the `javax.ejb.EJBObject` or `javax.ejb.EJBLocalObject` interface; and for the timeout callback methods, if any. Transaction attributes must not be specified for the methods of a session bean's home interface.
- For a EJB 2.1 (and earlier) entity bean, the transaction attributes are specified for the methods defined in the bean's component interface and all the direct and indirect superinterfaces of the component interface, excluding the `getEJBHome`, `getEJBLocalHome`, `getHandle`, `getPrimaryKey`, and `isIdentical` methods; for the methods defined in the bean's home interface and all the direct and indirect superinterfaces of the home interface, excluding the `getEJBMetaData` and `getHomeHandle` methods specific to the remote home interface; and for the timeout callback methods, if any.^[66]

By default, if a `TransactionAttribute` annotation is not specified for a method of an enterprise bean with container-managed transaction demarcation, the value of the transaction attribute for the method is defined to be `REQUIRED`. The rules for the specification of transaction attributes are defined in Section 13.3.7.1.

The Bean Provider may use the deployment descriptor as an alternative to metadata annotations to specify the transaction attributes (or as a means to supplement or override metadata annotations for transaction attributes). Transaction attributes specified in the deployment descriptor are assumed to override or supplement transaction attributes specified in annotations. If a transaction attribute value is not specified in the deployment descriptor, it is assumed that the transaction attribute specified in annotations applies, or—in the case that no annotation has been specified—that the value is `Required`.

The application assembler is permitted to override the transaction attribute values using the bean's deployment descriptor. The deployer is also permitted to override the transaction attribute values at deployment time. Caution should be exercised when overriding the transaction attributes of an application, as the transactional structure of an application is typically intrinsic to the semantics of the application.

Enterprise JavaBeans defines the following values for the `TransactionAttribute` metadata annotation:

- `MANDATORY`

[66] Note that the deployment descriptor must be used to specify transaction attributes for EJB 2.1 and earlier entity bean methods if the transaction attribute is not `Required` (the default value).

- `REQUIRED`
- `REQUIRES_NEW`
- `SUPPORTS`
- `NOT_SUPPORTED`
- `NEVER`

The deployment descriptor values that correspond to these annotation values are the following:

- `Mandatory`
- `Required`
- `RequiresNew`
- `Supports`
- `NotSupported`
- `Never`

In this chapter, we use the `TransactionAttribute` annotation values to refer to transaction attributes. As noted, however, the deployment descriptor may be used.

Refer to Subsection 13.6.2 for the specification of how the value of the transaction attribute affects the transaction management performed by the container.

For a message-driven bean's message listener methods (or interface), only the `REQUIRED` and `NOT_SUPPORTED` `TransactionAttribute` values may be used.

For an enterprise bean's timeout callback methods, only the `REQUIRED`, `REQUIRES_NEW` and `NOT_SUPPORTED` transaction attributes may be used.

For a session bean's asynchronous business methods, only the `REQUIRED`, `REQUIRES_NEW`, and `NOT_SUPPORTED` transaction attributes may be used.

For a singleton session bean's `PostConstruct/PreDestroy` lifecycle callback interceptor methods, only the `REQUIRED`, `REQUIRES_NEW`, and `NOT_SUPPORTED` transaction attributes may be used.

If an enterprise bean implements the `javax.ejb.SessionSynchronization` interface or uses at least one of the session synchronization annotations, only the following values may be used for the transaction attributes of the bean's methods: `REQUIRED`, `REQUIRES_NEW`, `MANDATORY`.

The above restriction is necessary to ensure that the enterprise bean is invoked only in a transaction. If the bean were invoked without a transaction, the container would not be able to send the transaction synchronization calls.

For entity beans that use EJB 2.1 container-managed persistence, only the `Required`, `RequiresNew`, or `Mandatory` deployment descriptor transaction attribute values should be used for the methods defined in the bean's component interface and all the direct and indirect superinterfaces of the component interface, excluding the `getEJBHome`, `getEJBLocalHome`, `getHandle`, `getPrimaryKey`, and `isIdentical` methods; and for the methods defined in the bean's home interface and all the direct and indirect superinterfaces of the home interface, excluding the `getEJB-
Metadata` and `getHomeHandle` methods specific to the remote home interface.

The Bean Provider and Application Assembler must exercise caution when using the `RequiresNew` transaction attributes with the navigation of container-managed relationships. If higher levels of isolation are used, navigating a container-managed relationship in a new transaction context may result in deadlock.

Containers may *optionally* support the use of the `NotSupported`, `Supports`, and `Never` transaction attributes for the methods of EJB 2.1 entity beans with container-managed persistence. However, entity beans with container-managed persistence that use these transaction attributes will not be portable.

Containers may optionally support the use of the `NotSupported`, `Supports`, and `Never` transaction attributes for the methods of EJB 2.1 entity beans with container-managed persistence because the use of these transaction modes may be needed to make use of container-managed persistence with non-transactional data stores. In general, however, the Bean Provider and Application Assembler should avoid use of the `NotSupported`, `Supports`, and `Never` transaction attribute values for the methods of entity beans with container-managed persistence because it may lead to inconsistent results or to the inconsistent and/or to the partial updating of persistent state and relationships in the event of concurrent use.

13.3.7.1 Specification of Transaction Attributes with Metadata Annotations

The following is the description of the rules for the specification of transaction attributes using Java language metadata annotations.

The `TransactionAttribute` annotation is used to specify a transaction attribute. The value of the transaction attribute annotation is given by the enum `TransactionAttributeType`:

```
public enum TransactionAttributeType {
    MANDATORY,
    REQUIRED,
    REQUIRES_NEW,
    SUPPORTS,
    NOT_SUPPORTED,
    NEVER
}
```

The transaction attributes for the methods of a bean class may be specified on the class, the business methods of the class, or both.

Specifying the `TransactionAttribute` annotation on the bean class means that it applies to all applicable business interface methods of the class. If the transaction attribute type is not specified, it is assumed to be `REQUIRED`. The absence of a transaction attribute specification on the bean class is equivalent to the specification of `TransactionAttribute (REQUIRED)` on the bean class.

A transaction attribute may be specified on a method of the bean class to override the transaction attribute value explicitly or implicitly specified on the bean class.

If the bean class has superclasses, the following additional rules apply.

- A transaction attribute specified on a superclass *S* applies to the business methods defined by *S*. If a class-level transaction attribute is not specified on *S*, it is equivalent to specification of `TransactionAttribute (REQUIRED)` on *S*.
- A transaction attribute may be specified on a business method *M* defined by class *S* to override for method *M* the transaction attribute value explicitly or implicitly specified on the class *S*.
- If a method *M* of class *S* overrides a business method defined by a superclass of *S*, the transaction attribute of *M* is determined by the above rules as applied to class *S*.

Example:

```
@TransactionAttribute (SUPPORTS)
public class SomeClass {
    public void aMethod () {...}
    public void bMethod () {...}
    ...
}

@Stateless public class ABean extends SomeClass implements A {
    public void aMethod () {...}

    @TransactionAttribute (REQUIRES_NEW)
    public void cMethod () {...}
    ...
}
```

Assuming `aMethod`, `bMethod`, `cMethod` are methods of interface `A`, their transaction attributes are `REQUIRED`, `SUPPORTS`, and `REQUIRES_NEW` respectively.

13.3.7.2 Specification of Transaction Attributes in the Deployment Descriptor

The following is the description of the rules for the specification of transaction attributes in the deployment descriptor. (See Section 19.5 for the complete syntax of the deployment descriptor.)

Note that even in the absence of the use of annotations, it is not necessary to explicitly specify transaction attributes for all of the methods listed in section 13.3.7. If a transaction attribute is not specified for a method in an EJB 3.1 deployment descriptor, the transaction attribute defaults to `Required`.

If the deployment descriptor is used to override annotations, and transaction attributes are not specified for some methods, the values specified in annotations (whether explicit or defaulted) will apply for those methods.

13.3.7.2.1 Use of the container-transaction element

The `container-transaction` element may be used to define the transaction attributes for business, home, component, and message-listener interface methods; no-interface view methods; web service endpoint methods; and timeout callback methods. Each `container-transaction` element consists of a list of one or more method elements, and the `trans-attribute` element. The `container-transaction` element specifies that all the listed methods are assigned the specified transaction attribute value. It is required that all the methods specified in a single `container-transaction` element be methods of the same enterprise bean.

The method element uses the `ejb-name`, `method-name`, and `method-params` elements to denote one or more methods. There are three legal styles of composing the method element:

Style 1:

```
<method>
  <ejb-name>EJBNAME</ejb-name>
  <method-name>*</method-name>
</method>
```

This style is used to specify a default value of the transaction attribute for the methods for which there is no Style 2 or Style 3 element specified. There must be at most one `container-transaction` element that uses the Style 1 method element for a given enterprise bean.

Style 2:

```
<method>
  <ejb-name>EJBNAME</ejb-name>
  <method-name>METHOD</method-name>
</method>
```

This style is used for referring to a specified method of a business, home, component or message listener interface method; no-interface view method; web service endpoint method; or timeout callback method of the specified enterprise bean. If there are multiple methods with the same overloaded name, this style refers to all the methods with the same name. There must be at most one `container-transaction` element that uses the Style 2 method element for a given method name. If there is also a `container-transaction` element that uses Style 1 element for the same bean, the value specified by the Style 2 element takes precedence.

Style 3:

```
<method>
  <ejb-name>EJBNAME</ejb-name>
  <method-name>METHOD</method-name>
  <method-params>
    <method-param>PARAMETER_1</method-param>
    ...
    <method-param>PARAMETER_N</method-param>
  </method-params>
</method>
```

This style is used to refer to a single method within a set of methods with an overloaded name. If there is also a `container-transaction` element that uses the Style 2 element for the method name, or the Style 1 element for the bean, the value specified by the Style 3 element takes precedence.

The optional `method-intf` element can be used to differentiate between methods with the same name and signature that are multiply defined across the business, component, and home interfaces, and/or web service endpoint, and/or no-interface view. However, if the same method is a method of a local business interface, local component interface, or no-interface view, the same transaction attribute applies to the method for all of them. Likewise, if the same method is a method of both a remote business interface and the remote component interface, the same transaction attribute applies to the method for both interfaces.

The following is an example of the specification of the transaction attributes in the deployment descriptor. The `updatePhoneNumber` method of the `EmployeeRecord` enterprise bean is assigned the transaction attribute `Mandatory`; all other methods of the `EmployeeRecord` bean are assigned the attribute `Required`. All the methods of the enterprise bean `AardvarkPayroll` are assigned the attribute `RequiresNew`.

```
<ejb-jar>
  ...
  <assembly-descriptor>
    ...
    <container-transaction>
      <method>
        <ejb-name>EmployeeRecord</ejb-name>
        <method-name>*</method-name>
      </method>
      <trans-attribute>Required</trans-attribute>
    </container-transaction>

    <container-transaction>
      <method>
        <ejb-name>EmployeeRecord</ejb-name>
        <method-name>updatePhoneNumber</method-name>
      </method>
      <trans-attribute>Mandatory</trans-attribute>
    </container-transaction>

    <container-transaction>
      <method>
        <ejb-name>AardvarkPayroll</ejb-name>
        <method-name>*</method-name>
      </method>
      <trans-attribute>RequiresNew</trans-attribute>
    </container-transaction>
  </assembly-descriptor>
</ejb-jar>
```

13.4 Application Assembler's Responsibilities

This section describes the view and responsibilities of the Application Assembler.

There is no mechanism for an Application Assembler to affect enterprise beans with bean-managed transaction demarcation. The Application Assembler must not define transaction attributes for an enterprise bean with bean-managed transaction demarcation.

The Application Assembler can use the deployment descriptor transaction attribute mechanism described above to override or change the transaction attributes for enterprise beans using container-managed transaction demarcation.

The Application Assembler should exercise caution in the changing the transaction attributes, as the behavior specified by the transaction attributes is typically an intrinsic part of the semantics of an application.

13.5 Deployer's Responsibilities

The Deployer is permitted to override or change the values of transaction attributes at deployment time.

The Deployer should exercise caution in the changing the transaction attributes, as the behavior specified by the transaction attributes is typically an intrinsic part of the semantics of an application.

Compatibility Note: For applications written to the EJB 2.1 specification (and earlier), the deployer is responsible for ensuring that the methods of the deployed enterprise beans with container-managed transaction demarcation have been assigned a transaction attribute if this has not been specified in the deployment descriptor.

13.6 Container Provider Responsibilities

This section defines the responsibilities of the Container Provider.

Every client method invocation on a session or entity bean via the bean's business interface (and/or home and component interface), no-interface view, web service endpoint, and every invocation of a message listener method on a message-driven bean is interposed by the container, and every connection to a resource manager used by an enterprise bean is obtained via the container. This managed execution environment allows the container to affect the enterprise bean's transaction management.

This does not imply that the container must interpose on every resource manager access performed by the enterprise bean. Typically, the container interposes only on the resource manager connection factory (e.g. a JDBC data source) JNDI look up by registering the container-specific implementation of the resource manager connection factory object. The resource manager connection factory object allows the container to obtain the `javax.transaction.xa.XAResource` interface as described in the JTA specification and pass it to the transaction manager. After the set up is done, the enterprise bean communicates with the resource manager without going through the container.

13.6.1 Bean-Managed Transaction Demarcation

This subsection defines the container's responsibilities for the transaction management of enterprise beans with bean-managed transaction demarcation.

Note that only session and message-driven beans can be used with bean-managed transaction demarcation.

The container must manage client invocations to an enterprise bean instance with bean-managed transaction demarcation as follows. When a client invokes a business method via one of the enterprise bean's client views, the container suspends any transaction that may be associated with the client request. If there is a transaction associated with the instance (this would happen if a stateful session bean instance started the transaction in some previous business method), the container associates the method execution with this transaction. If there are interceptor methods associated with the bean instances, these actions are taken before the interceptor methods are invoked.

The container must make the `javax.transaction.UserTransaction` interface available to the enterprise bean's business method, message listener method, interceptor method, or timeout callback method via dependency injection into the enterprise bean class or interceptor class, and through lookup via the `javax.ejb.EJBContext` interface, and in the JNDI naming context under `java:comp/UserTransaction`. When an instance uses the `javax.transaction.UserTransaction` interface to demarcate a transaction, the container must enlist all the resource managers used by the instance between the `begin` and `commit`—or `rollback`—methods with the transaction. When the instance attempts to commit the transaction, the container is responsible for the global coordination of the transaction commit^[67].

In the case of a *stateful* session bean, it is possible that the business method that started a transaction completes without committing or rolling back the transaction. In such a case, the container must retain the association between the transaction and the instance across multiple client calls until the instance commits or rolls back the transaction. When the client invokes the next business method, the container must invoke the business method (and any applicable interceptor methods for the bean) in this transaction context.

If a *stateless* or *singleton* session bean instance starts a transaction in a business method or interceptor method, it must commit the transaction before the business method (or all its interceptor methods) returns. The container must detect the case in which a transaction was started, but not completed, in the business method or interceptor method for the business method, and handle it as follows:

[67] The container typically relies on a transaction manager that is part of the EJB server to perform the two-phase commit across all the enlisted resource managers. If only a single resource manager is involved in the transaction and the deployment descriptor indicates that connection sharing may be used, the container may use the local transaction optimization. See [12] and [15] for further discussion.

- Log this as an application error to alert the System Administrator.
- Roll back the started transaction.
- If this a stateless session bean, discard the bean instance.
- Throw the `javax.ejb.EJBException`^[68]. If the EJB 2.1 client view is used, the container should throw `java.rmi.RemoteException` if the client is a remote client, or throw the `javax.ejb.EJBException` if the client is a local client.

If a message-driven bean instance starts a transaction in a message listener method or interceptor method, it must commit the transaction before the message listener method (or all its interceptor methods) returns. The container must detect the case in which a transaction was started, but not completed, in a message listener method or interceptor method for the message listener method, and handle it as follows:

- Log this as an application error to alert the System Administrator.
- Roll back the started transaction.
- Discard the instance of the message-driven bean.

If a session bean or message-driven bean instance starts a transaction in a timeout callback method, it must commit the transaction before the timeout callback method returns. The container must detect the case in which a transaction was started, but not completed, in a timeout callback method, and handle it as follows:

- Log this as an application error to alert the System Administrator.
- Roll back the started transaction.
- If this is a stateless session bean or message-driven bean, discard the instance of the bean.

The actions performed by the container for an instance with bean-managed transaction are summarized by the following table. T1 is a transaction associated with a client request, T2 is a transaction that is currently associated with the instance (i.e. a transaction that was started but not completed by a previous business method).

Table 13 Container's Actions for Methods of Beans with Bean-Managed Transaction

Client's transaction	Transaction currently associated with instance	Transaction associated with the method
none	none	none
T1	none	none

[68] If the business interface is a remote business interface that extends `java.rmi.Remote`, the `java.rmi.RemoteException` is thrown to the client instead.

Table 13 Container's Actions for Methods of Beans with Bean-Managed Transaction

Client's transaction	Transaction currently associated with instance	Transaction associated with the method
none	T2	T2
T1	T2	T2

The following items describe each entry in the table:

- If the client request is not associated with a transaction and the instance is not associated with a transaction, or if the bean is a message-driven bean, the container invokes the instance with an unspecified transaction context.
- If the client request is associated with a transaction T1, and the instance is not associated with a transaction, the container suspends the client's transaction association and invokes the method with an unspecified transaction context. The container resumes the client's transaction association (T1) when the method (together with any associated interceptor methods) completes. This case can never happen for a message-driven bean or for the invocation of a web service endpoint method of a session bean.
- If the client request is not associated with a transaction and the instance is already associated with a transaction T2, the container invokes the instance with the transaction that is associated with the instance (T2). This case can never happen for a stateless session bean, singleton session bean, or a message-driven bean: it can only happen for a stateful session bean.
- If the client is associated with a transaction T1, and the instance is already associated with a transaction T2, the container suspends the client's transaction association and invokes the method with the transaction context that is associated with the instance (T2). The container resumes the client's transaction association (T1) when the method (together with any associated interceptor methods) completes. This case can never happen for a stateless session bean, singleton session bean, or a message-driven bean: it can only happen for a stateful session bean.

The container must allow the enterprise bean instance to serially perform several transactions in a method.

When an instance attempts to start a transaction using the `begin` method of the `javax.transaction.UserTransaction` interface while the instance has not committed the previous transaction, the container must throw the `javax.transaction.NotSupportedException` in the `begin` method.

The container must throw the `java.lang.IllegalStateException` if an instance of a bean with bean-managed transaction demarcation attempts to invoke the `setRollbackOnly` or `getRollbackOnly` method of the `javax.ejb.EJBContext` interface.

13.6.2 Container-Managed Transaction Demarcation for Session and Entity Beans

The container is responsible for providing the transaction demarcation for the session beans declared with container-managed transaction demarcation, entity beans with bean-managed persistence, and for EJB 2.1 and EJB 1.1 entity beans with container-managed persistence. For these enterprise beans, the container must demarcate transactions as specified by the transaction attribute values specified using metadata annotations in the bean class or specified in the deployment descriptor.

The following subsections define the responsibilities of the container for managing the invocation of an enterprise bean business method when the method is invoked via the enterprise bean's business interface (and/or home or component interface), no-interface view, or web service endpoint. The container's responsibilities depend on the value of the transaction attribute.

13.6.2.1 NOT_SUPPORTED

The container invokes an enterprise bean method whose transaction attribute is set to the `NOT_SUPPORTED` value with an unspecified transaction context.

If a client calls with a transaction context, the container suspends the association of the transaction context with the current thread before invoking the enterprise bean's business method. The container resumes the suspended association when the business method has completed. The suspended transaction context of the client is not passed to the resource managers or other enterprise bean objects that are invoked from the business method.

If the business method invokes other enterprise beans, the container passes no transaction context with the invocation.

Refer to Subsection 13.6.5 for more details of how the container can implement this case.

13.6.2.2 REQUIRED

The container must invoke an enterprise bean method whose transaction attribute is set to the `REQUIRED` value with a valid transaction context.

If a client invokes the enterprise bean's method while the client is associated with a transaction context, the container invokes the enterprise bean's method in the client's transaction context.

If the client invokes the enterprise bean's method while the client is not associated with a transaction context, the container automatically starts a new transaction before delegating a method call to the enterprise bean business method. The container automatically enlists all the resource managers accessed by the business method with the transaction. If the business method invokes other enterprise beans, the container passes the transaction context with the invocation. The container attempts to commit the transaction when the business method has completed. The container performs the commit protocol before the method result is sent to the client.

13.6.2.3 SUPPORTS

The container invokes an enterprise bean method whose transaction attribute is set to `SUPPORTS` as follows.

- If the client calls with a transaction context, the container performs the same steps as described in the `REQUIRED` case.
- If the client calls without a transaction context, the container performs the same steps as described in the `NOT_SUPPORTED` case.

The `SUPPORTS` transaction attribute must be used with caution. This is because of the different transactional semantics provided by the two possible modes of execution. Only the enterprise beans that will execute correctly in both modes should use the `SUPPORTS` transaction attribute.

13.6.2.4 REQUIRES_NEW

The container must invoke an enterprise bean method whose transaction attribute is set to `REQUIRES_NEW` with a new transaction context.

If the client invokes the enterprise bean's method while the client is not associated with a transaction context, the container automatically starts a new transaction before delegating a method call to the enterprise bean business method. The container automatically enlists all the resource managers accessed by the business method with the transaction. If the business method invokes other enterprise beans, the container passes the transaction context with the invocation. The container attempts to commit the transaction when the business method has completed. The container performs the commit protocol before the method result is sent to the client.

If a client calls with a transaction context, the container suspends the association of the transaction context with the current thread before starting the new transaction and invoking the business method. The container resumes the suspended transaction association after the business method and the new transaction have been completed.

13.6.2.5 MANDATORY

The container must invoke an enterprise bean method whose transaction attribute is set to `MANDATORY` in a client's transaction context. The client is required to call with a transaction context.

- If the client calls with a transaction context, the container performs the same steps as described in the `REQUIRED` case.
- If the client calls without a transaction context, the container throws the `javax.ejb.EJBTransactionRequiredException`^[69]. If the EJB 2.1 client view is used, the container throws the `javax.transaction.TransactionRequiredException` exception if

[69] If the business interface is a remote business interface that extends `java.rmi.Remote`, the `javax.transaction.TransactionRequiredException` is thrown to the client instead.

the client is a remote client, or the `javax.ejb.TransactionRequiredLocalException` if the client is a local client.

13.6.2.6 NEVER

The container invokes an enterprise bean method whose transaction attribute is set to `NEVER` without a transaction context defined by the EJB specification. The client is required to call without a transaction context.

- If the client calls with a transaction context, the container throws the `javax.ejb.EJBException`^[70]. If the EJB 2.1 client view is used, the container throws the `java.rmi.RemoteException` exception if the client is a remote client, or the `javax.ejb.EJBException` if the client is a local client.
- If the client calls without a transaction context, the container performs the same steps as described in the `NOT_SUPPORTED` case.

13.6.2.7 Transaction Attribute Summary

The following table provides a summary of the transaction context that the container passes to the business method and resource managers used by the business method, as a function of the transaction attribute and the client's transaction context. T1 is a transaction passed with the client request, while T2 is a transaction initiated by the container.

Table 14 Transaction Attribute Summary

Transaction attribute	Client's transaction	Transaction associated with business method	Transaction associated with resource managers
NOT_SUPPORTED	none	none	none
	T1	none	none
REQUIRED	none	T2	T2
	T1	T1	T1
SUPPORTS	none	none	none
	T1	T1	T1
REQUIRES_NEW	none	T2	T2
	T1	T2	T2

[70] If the business interface is a remote business interface that extends `java.rmi.Remote`, the `java.rmi.RemoteException` is thrown to the client instead.

Table 14 Transaction Attribute Summary

Transaction attribute	Client's transaction	Transaction associated with business method	Transaction associated with resource managers
MANDATORY	none	error	N/A
	T1	T1	T1
NEVER	none	none	none
	T1	error	N/A

If the enterprise bean's business method invokes other enterprise beans via their business interfaces or home and component interfaces, the transaction indicated in the column "Transaction associated with business method" will be passed as part of the client context to the target enterprise bean.

See Subsection 13.6.5 for how the container handles the "none" case in Table 14.

13.6.2.8 Handling of `setRollbackOnly` Method

The container must handle the `EJBContext.setRollbackOnly` method invoked from a business method executing with the `REQUIRED`, `REQUIRES_NEW`, or `MANDATORY` transaction attribute as follows:

- The container must ensure that the transaction will never commit. Typically, the container instructs the transaction manager to mark the transaction for rollback.
- If the container initiated the transaction immediately before dispatching the business method to the instance (as opposed to the transaction being inherited from the caller), the container must note that the instance has invoked the `setRollbackOnly` method. When the business method invocation completes, the container must roll back rather than commit the transaction. If the business method has returned normally or with an application exception, the container must pass the method result or the application exception to the client after the container performed the rollback.

The container must throw the `java.lang.IllegalStateException` if the `EJBContext.setRollbackOnly` method is invoked from a business method executing with the `SUPPORTS`, `NOT_SUPPORTED`, or `NEVER` transaction attribute.

13.6.2.9 Handling of `getRollbackOnly` Method

The container must handle the `EJBContext.getRollbackOnly` method invoked from a business method executing with the `REQUIRED`, `REQUIRES_NEW`, or `MANDATORY` transaction attribute.

The container must throw the `java.lang.IllegalStateException` if the `EJBContext.getRollbackOnly` method is invoked from a business method executing with the `SUPPORTS`, `NOT_SUPPORTED`, or `NEVER` transaction attribute.

13.6.2.10 Handling of `getUserTransaction` Method

If an instance of an enterprise bean with container-managed transaction demarcation attempts to invoke the `getUserTransaction` method of the `EJBContext` interface, the container must throw the `java.lang.IllegalStateException`.

13.6.2.11 Session Synchronization Callbacks

If a session bean class implements the `javax.ejb.SessionSynchronization` interface or uses the session synchronization annotations, the container must invoke the `afterBegin`, `beforeCompletion`, and `afterCompletion` callbacks on the instance as part of the transaction commit protocol.

The container invokes the `afterBegin` method on an instance before it invokes the first business method in a transaction.

The container invokes the `beforeCompletion` method to give the enterprise bean instance the last chance to cause the transaction to rollback. The instance may cause the transaction to roll back by invoking the `EJBContext.setRollbackOnly` method.

The container invokes the `afterCompletion(boolean committed)` method after the completion of the transaction commit protocol to notify the enterprise bean instance of the transaction outcome.

13.6.2.12 Timing of Return Value Marshalling w.r.t. Transaction Boundaries

When demarcating a container-managed transaction for a business method invocation through a Remote view or Web Service view, the container must complete the commit protocol before marshalling the return value.

13.6.3 Container-Managed Transaction Demarcation for Message-Driven Beans

The container is responsible for providing the transaction demarcation for the message-driven beans that the Bean Provider declared as with container-managed transaction demarcation. For these enterprise beans, the container must demarcate transactions as specified by annotations on the bean class or in the deployment descriptor. (See Chapter 19 for more information about the deployment descriptor.)

The following subsections define the responsibilities of the container for managing the invocation of a message-driven bean's message listener method. The container's responsibilities depend on the value of the transaction attribute.

Only the `NOT_SUPPORTED` and `REQUIRED` transaction attributes may be used for message-driven bean message listener methods. The use of the other transaction attributes is not meaningful for message-driven bean message listener methods because there is no pre-existing client transaction context (`REQUIRES_NEW`, `SUPPORTS`) and no client to handle exceptions (`MANDATORY`, `NEVER`).

13.6.3.1 NOT_SUPPORTED

The container invokes a message-driven bean message listener method whose transaction attribute is set to `NOT_SUPPORTED` with an unspecified transaction context.

If the message listener method invokes other enterprise beans, the container passes no transaction context with the invocation.

13.6.3.2 REQUIRED

The container must invoke a message-driven bean message listener method whose transaction attribute is set to `REQUIRED` with a valid transaction context. The resource managers accessed by the message listener method within the transaction are enlisted with the transaction. If the message listener method invokes other enterprise beans, the container passes the transaction context with the invocation. The container attempts to commit the transaction when the message listener method has completed.

Messaging systems may differ in quality of service with regard to reliability and transactionality of the dequeuing of messages.

The requirement for JMS are as follows:

A transaction must be started before the dequeuing of the JMS message and, hence, before the invocation of the message-driven bean's `onMessage` method. The resource manager associated with the arriving message is enlisted with the transaction as well as all the resource managers accessed by the `onMessage` method within the transaction. If the `onMessage` method invokes other enterprise beans, the container passes the transaction context with the invocation. The transaction is committed when the `onMessage` method has completed. If the `onMessage` method does not successfully complete or the transaction is rolled back, message redelivery semantics apply.

13.6.3.3 Handling of `setRollbackOnly` Method

The container must handle the `EJBContext.setRollbackOnly` method invoked from a message listener method executing with the `REQUIRED` transaction attribute as follows:

- The container must ensure that the transaction will never commit. Typically, the container instructs the transaction manager to mark the transaction for rollback.
- The container must note that the instance has invoked the `setRollbackOnly` method. When the method invocation completes, the container must roll back rather than commit the transaction.

The container must throw and log the `java.lang.IllegalStateException` if the `EJBContext.setRollbackOnly` method is invoked from a message listener method executing with the `NotSupported` transaction attribute

13.6.3.4 Handling of `getRollbackOnly` Method

The container must handle the `EJBContext.getRollbackOnly()` method invoked from a message listener method executing with the `REQUIRED` transaction attribute.

The container must throw and log the `java.lang.IllegalStateException` if the `EJBContext.getRollbackOnly` method is invoked from a message listener method executing with the `NOT_SUPPORTED` transaction attribute.

13.6.3.5 Handling of `getUserTransaction` Method

If an instance of a message-driven bean with container-managed transaction demarcation attempts to invoke the `getUserTransaction` method of the `EJBContext` interface, the container must throw and log the `java.lang.IllegalStateException`.

13.6.4 Local Transaction Optimization

The container may use a local transaction optimization for enterprise beans whose metadata annotations or deployment descriptor indicates that connections to a resource manager are shareable (see Section 16.7.1.3, “Declaration of Resource Manager Connection Factory References in Deployment Descriptor”). The container manages the use of the local transaction optimization transparent to the application.

The container may use the optimization for transactions initiated by the container for a bean with container-managed transaction demarcation and for transactions initiated by a bean with bean-managed transaction demarcation with the `UserTransaction` interface. The container cannot apply the optimization for transactions imported from a different container.

The use of local transaction optimization approach is discussed in [12] and [15].

13.6.5 Handling of Methods that Run with “an unspecified transaction context”

The term “an unspecified transaction context” is used in the EJB specification to refer to the cases in which the EJB architecture does not fully define the transaction semantics of an enterprise bean method execution.

This includes the following cases:

- The execution of a method of an enterprise bean with container-managed transaction demarcation for which the value of the transaction attribute is `NOT_SUPPORTED`, `NEVER`, or `SUPPORTS`.
- The execution of a `PostConstruct`, `PreDestroy`, `PostActivate`, or `PrePassivate` callback method of a session bean with container-managed transaction demarcation.^[71]

[71] Except Singleton `PostConstruct/PreDestroy` methods. See Chapter 4, “Session Bean Component Contract”.

- The execution of a `PostConstruct` or `PreDestroy` callback method of a message-driven bean with container-managed transaction demarcation.^[72]

The EJB specification does not prescribe how the container should manage the execution of a method with an unspecified transaction context—the transaction semantics are left to the container implementation. Some techniques for how the container may choose to implement the execution of a method with an unspecified transaction context are as follows (the list is not inclusive of all possible strategies):

- The container may execute the method and access the underlying resource managers without a transaction context.
- The container may treat each call of an instance to a resource manager as a single transaction (e.g. the container may set the auto-commit option on a JDBC connection).
- The container may merge multiple calls of an instance to a resource manager into a single transaction.
- The container may merge multiple calls of an instance to multiple resource managers into a single transaction.
- If an instance invokes methods on other enterprise beans, and the invoked methods are also designated to run with an unspecified transaction context, the container may merge the resource manager calls from the multiple instances into a single transaction.
- Any combination of the above.

Since the enterprise bean does not know which technique the container implements, the enterprise bean must be written conservatively not to rely on any particular container behavior.

A failure that occurs in the middle of the execution of a method that runs with an unspecified transaction context may leave the resource managers accessed from the method in an unpredictable state. The EJB architecture does not define how the application should recover the resource managers' state after such a failure.

13.7 Access from Multiple Clients in the Same Transaction Context

This section describes a more complex distributed transaction scenario, and specifies the container's behavior required for this scenario.

[72] See Chapter 5, "Message-Driven Bean Component Contract".

13.7.1 Transaction “Diamond” Scenario with an Entity Object

An entity object may be accessed by multiple clients in the same transaction. For example, program A may start a transaction, call program B and program C in the transaction context, and then commit the transaction. If programs B and C access the same entity object, the topology of the transaction creates a diamond.

Figure 30 Transaction Diamond Scenario with Entity Object

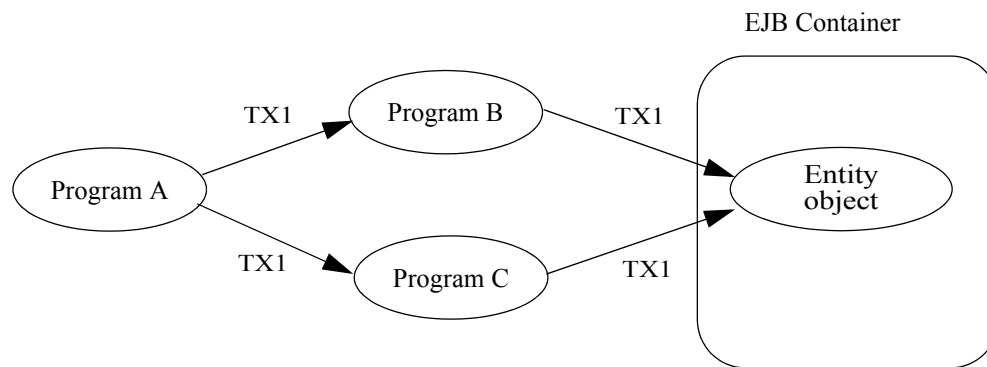

An example (not realistic in practice) is a client program that tries to perform two purchases at two different stores within the same transaction. At each store, the program that is processing the client's purchase request debits the client's bank account.

It is difficult to implement an EJB server that handles the case in which programs B and C access an entity object through different network paths. This case is challenging because many EJB servers implement the EJB container as a collection of multiple processes, running on the same or multiple machines. Each client is typically connected to a single process. If clients B and C connect to different EJB container processes, and both B and C need to access the same entity object in the same transaction, the issue is how the container can make it possible for B and C to see a consistent state of the entity object within the same transaction^[73].

The above example illustrates a simple diamond. We use the term diamond to refer to any distributed transaction scenario in which an entity object is accessed in the same transaction through multiple network paths.

Note that in the diamond scenario the clients B and C access the entity object serially. Concurrent access to an entity object in the same transaction context would be considered an application programming error, and it would be handled in a container-specific way.

Note that the issue of handling diamonds is not unique to the EJB architecture. This issue exists in all distributed transaction processing systems.

[73] This diamond problem applies only to the case when B and C are in the same transaction.

The following subsections define the responsibilities of the EJB Roles when handling distributed transaction topologies that may lead to a diamond involving an entity object.

13.7.2 Container Provider's Responsibilities

This Subsection specifies the EJB container's responsibilities with respect to the diamond case involving an entity object.

The EJB specification requires that the container provide support for local diamonds. In a local diamond, components A, B, C, and D are deployed in the same EJB container.

The EJB specification does not require an EJB container to support distributed diamonds. In a distributed diamond, a target entity object is accessed from multiple clients in the same transaction through multiple network paths, and the clients (programs B and C) are not enterprise beans deployed in the same EJB container as the target entity object.

If the Container Provider chooses not to support distributed diamonds, and if the container can detect that a client invocation would lead to a diamond, the container should throw the `javax.ejb.EJBException` (or `java.rmi.RemoteException` if the EJB 2.1 remote client view is used).

13.7.3 Bean Provider's Responsibilities

This Subsection specifies the Bean Provider's responsibilities with respect to the diamond case involving an entity object.

The diamond case is transparent to the Bean Provider—the Bean Provider does not have to code the enterprise bean differently for the bean to participate in a diamond. Any solution to the diamond problem implemented by the container is transparent to the bean and does not change the semantics of the bean.

13.7.4 Application Assembler and Deployer's Responsibilities

This Subsection specifies the Application Assembler and Deployer's responsibilities with respect to the diamond case involving an entity object.

The Application Assembler and Deployer should be aware that distributed diamonds might occur. In general, the Application Assembler should try to avoid creating unnecessary distributed diamonds.

If a distributed diamond is necessary, the Deployer should advise the container (using a container-specific API) that an entity objects of the entity bean may be involved in distributed diamond scenarios.

13.7.5 Transaction Diamonds involving Session Objects

While it is illegal for two clients to access the same session object, it is possible for applications that use session beans to encounter the diamond case. For example, program A starts a transaction and then invokes two different session objects.

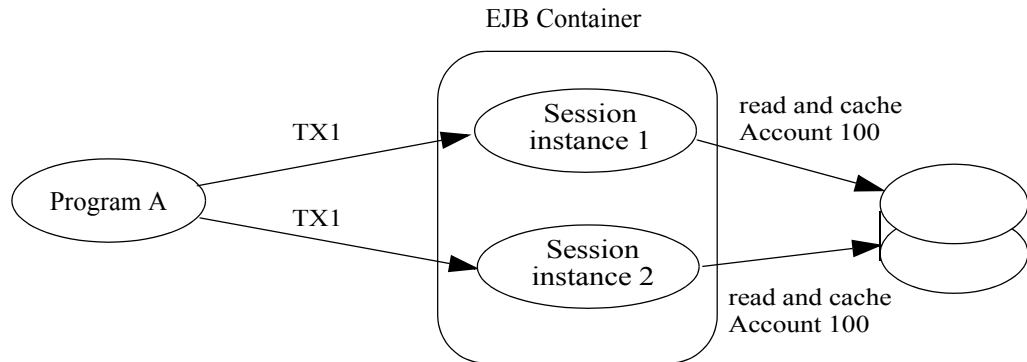
Figure 31 Transaction Diamond Scenario with a Session Bean

If the session bean instances cache the same data item (e.g. the current balance of Account 100) across method invocations in the same transaction, most likely the program is going to produce incorrect results.

The problem may exist regardless of whether the two session objects are the same or different session beans. The problem may exist (and may be harder to discover) if there are intermediate objects between the transaction initiator and the session objects that cache the data.

There are no requirements for the Container Provider because it is impossible for the container to detect this problem.

The Bean Provider and Application Assembler must avoid creating applications that would result in inconsistent caching of data in the same transaction by multiple session objects.

Exception Handling

14.1 Overview and Concepts

14.1.1 Application Exceptions

An *application exception* is an exception defined by the Bean Provider as part of the business logic of an application. *Application exceptions* are distinguished from *system exceptions* in this specification.

Enterprise bean business methods use application exceptions to inform the client of abnormal application-level conditions, such as unacceptable values of the input arguments to a business method. A client can typically recover from an application exception. Application exceptions are not intended for reporting system-level problems.

For example, the Account enterprise bean may throw an application exception to report that a debit operation cannot be performed because of an insufficient balance. The Account bean should not use an application exception to report, for example, the failure to obtain a database connection.

An application exception may be defined in the `throws` clause of a method of an enterprise bean's business interface, no-interface view, home interface, component interface, message listener interface, or web service endpoint.

An application exception may be a subclass (direct or indirect) of `java.lang.Exception` (i.e., a “checked exception”), or an application exception class may be defined as a subclass of the `java.lang.RuntimeException` (an “unchecked exception”). An application exception may not be a subclass of the `java.rmi.RemoteException`. The `java.rmi.RemoteException` and its subclasses are reserved for system exceptions.

The `javax.ejb.CreateException`, `javax.ejb.RemoveException`, `javax.ejb.FinderException`, and subclasses thereof are considered to be application exceptions. These exceptions are used as standard application exceptions to report errors to the client from the `create`, `remove`, and `finder` methods of the `EJBHome` and/or `EJBLocalHome` interfaces of components written to the EJB 2.1 client view (see Subsections 8.5.10 and 10.1.11). These exceptions are covered by the rules on application exceptions that are defined in this chapter.

14.1.2 Goals for Exception Handling

The EJB specification for exception handling is designed to meet these high-level goals:

- An application exception thrown by an enterprise bean instance should be reported to the client *precisely* (i.e., the client gets the same exception)^[74].
- An application exception thrown by an enterprise bean instance should not automatically rollback a client's transaction unless the application exception was defined to cause transaction rollback. The client should typically be given a chance to recover a transaction from an application exception.
- An unexpected exception that may have left the instance's state variables and/or underlying persistent data in an inconsistent state can be handled safely.

14.2 Bean Provider's Responsibilities

This section describes the view and responsibilities of the Bean Provider with respect to exception handling.

14.2.1 Application Exceptions

The Bean Provider defines application exceptions. Application exceptions that are checked exceptions may be defined as such by being listed in the `throws` clauses of the methods of the bean's business interface, no-interface view, home interface, component interface, and web service endpoint. An application exception that is an unchecked exception is defined as an application exception by annotating it with the `ApplicationException` metadata annotation, or denoting it in the deployment descriptor with the `application-exception` element.

[74] This may not be the case where web services protocols are used. See [25].

Because application exceptions are intended to be handled by the client, and not by the System Administrator, they should be used only for reporting business logic exceptions, not for reporting system level problems.

Certain messaging types may define application exceptions in their message listener interfaces. The resource adapter in use for the particular messaging type determines how the exception is processed. See [15].

The Bean Provider is responsible for throwing the appropriate application exception from the business method to report a business logic exception to the client.

An application exception does not automatically result in marking the transaction for rollback unless the `ApplicationException` annotation is applied to the exception class and is specified with the `rollback` element value `true` or the `application-exception` deployment descriptor element for the exception specifies the `rollback` element as `true`. The `rollback` subelement of the `application-exception` deployment descriptor element may be explicitly specified to override the `rollback` value specified or defaulted by the `ApplicationException` annotation.

The Bean Provider must do one of the following to ensure data integrity before throwing an application exception from an enterprise bean instance:

- Ensure that the instance is in a state such that a client's attempt to continue and/or commit the transaction does not result in loss of data integrity. For example, the instance throws an application exception indicating that the value of an input parameter was invalid before the instance performed any database updates.
- If the application exception is not specified to cause transaction rollback, mark the transaction for rollback using the `EJBContext.setRollbackOnly` method before throwing the application exception. Marking the transaction for rollback will ensure that the transaction can never commit.

The Bean Provider is also responsible for using the standard EJB application exceptions (`javax.ejb.CreateException`, `javax.ejb.RemoveException`, `javax.ejb.FinderException`, and subclasses thereof) for beans written to the EJB 2.1 and earlier client view as described in Subsections 8.5.10 and 10.1.11.

Bean Providers may define subclasses of the standard EJB application exceptions and throw instances of the subclasses in the enterprise bean methods. A subclass will typically provide more information to the client that catches the exception.

By default, designating an unchecked exception as an application exception also applies to subclasses of that exception. The inheriting behavior can be disabled by setting the `@ApplicationException` `inherited` attribute to `false` or by setting the `inherited` element of the `application-exception` deployment descriptor to `false`.

In the following example :

```
@ApplicationException(rollback=true)
public class ExceptionA extends RuntimeException

public class ExceptionB extends ExceptionA

@ApplicationException(inherited=false, rollback=false)
public class ExceptionC extends ExceptionB

public class ExceptionD extends ExceptionC
```

ExceptionA is an application exception with transaction rollback.

ExceptionB is an application exception with transaction rollback.

ExceptionC is an application exception without transaction rollback.

ExceptionD is not an application exception.

14.2.2 System Exceptions

A system exception is an exception that is a `java.rmi.RemoteException` (or one of its subclasses) or a `RuntimeException` that is not an application exception.

This subsection describes how the Bean Provider should handle various system-level exceptions and errors that an enterprise bean instance may encounter during the execution of a session or entity bean business method, a message-driven bean message listener method, an interceptor method, or a callback method (e.g. `ejbLoad`).

An enterprise bean business method, message listener method, business method interceptor method, or lifecycle callback interceptor method may encounter various exceptions or errors that prevent the method from successfully completing. Typically, this happens because the exception or error is unexpected, or the exception is expected but the EJB Provider does not know how to recover from it. Examples of such exceptions and errors are: failure to obtain a database connection, JNDI exceptions, unexpected `RemoteException` from invocation of other enterprise beans^[75], unexpected `RuntimeException`, JVM errors, and so on.

If the enterprise bean method encounters a system-level exception or error that does not allow the method to successfully complete, the method should throw a suitable non-application exception that is compatible with the method's `throws` clause. While the EJB specification does not prescribe the exact usage of the exception, it encourages the Bean Provider to follow these guidelines:

- If the bean method encounters a system exception or error, it should simply propagate the error from the bean method to the container (i.e., the bean method does not have to catch the exception).

[75] Note that the enterprise bean business method may attempt to recover from a `RemoteException`. The text in this subsection applies only to the case when the business method does not wish to recover from the `RemoteException`.

- If the bean method performs an operation that results in a checked exception^[76] that the bean method cannot recover, the bean method should throw the `javax.ejb.EJBException` that wraps the original exception.
- Any other unexpected error conditions should be reported using the `javax.ejb.EJBException`.

Note that the `javax.ejb.EJBException` is a subclass of the `java.lang.RuntimeException`, and therefore it does not have to be listed in the `throws` clauses of the business methods.

The container catches a non-application exception; logs it (which can result in alerting the System Administrator); and, unless the bean is a message-driven bean, throws the `javax.ejb.EJBException`^[77] or, if the web service client view is used, the `java.rmi.RemoteException`. If the EJB 2.1 client view is used, the container throws the `java.rmi.RemoteException` (or subclass thereof) to the client if the client is a remote client, or throws the `javax.ejb.EJBException` (or subclass thereof) to the client if the client is a local client. In the case of a message-driven bean, the container logs the exception and then throws a `javax.ejb.EJBException` that wraps the original exception to the resource adapter. (See [15]).

The exception that is seen by the client is described in section 14.3. It is determined both by the exception that is thrown by the container and/or bean and the client view.

The Bean Provider can rely on the container to perform the following tasks when catching a non-application exception:

- The transaction in which the bean method participated will be rolled back.
- Unless the bean is a Singleton bean, no other method will be invoked on an instance that threw a non-application exception.

This means that unless the bean is a Singleton the Bean Provider does not have to perform any cleanup actions before throwing a non-application exception. It is the container that is responsible for the cleanup.

14.2.2.1 `javax.ejb.NoSuchEntityException`

The `NoSuchEntityException` is a subclass of `EJBException`. It should be thrown by the EJB 2.1 entity bean class methods to indicate that the underlying entity has been removed from the database.

A bean-managed persistence entity bean class typically throws this exception from the `ejbLoad` and `ejbStore` methods, and from the methods that implement the business methods defined in the component interface.

[76] A checked exception is one that is not a subclass of `java.lang.RuntimeException`.

[77] If the business interface is a remote business interface that extends `java.rmi.Remote`, the `java.rmi.RemoteException` is thrown to the client instead.

14.3 Container Provider Responsibilities

This section describes the responsibilities of the Container Provider for handling exceptions. The EJB architecture specifies the container's behavior for the following exceptions:

- Exceptions from the business methods of session and entity beans, including session bean business method interceptor methods.
- Exceptions from message-driven bean message listener methods and business method interceptor methods.
- Exceptions from timeout callback methods.
- Exceptions from other container-invoked callbacks on the enterprise bean.
- Exceptions from management of container-managed transaction demarcation.

14.3.1 Exceptions from a Session Bean's Business Interface Methods and No-Interface

View Methods

Table 15 specifies how the container must handle the exceptions thrown by the methods of the business interface and No-interface view for beans with container-managed transaction demarcation, including the exceptions thrown by business method interceptor methods which intercept the invocation of business methods. The table specifies the container's action as a function of the condition under which the business interface method executes and the exception thrown by the method. The table also illustrates the exception that the client will receive and how the client can recover from the exception. (Section 14.4 describes the client's view of exceptions in detail.) The notation "AppException" denotes an application exception.

Table 15 Handling of Exceptions Thrown by a Business Interface Method or No-interface View Method of a Bean with Container-Managed Transaction Demarcation

Method condition	Method exception	Container's action	Client's view
Bean method runs in the context of the caller's transaction [Note A]. This case may happen with <code>Required</code> , <code>Mandatory</code> , and <code>Supports</code> attributes.	AppException	Re-throw AppException. Mark the transaction for rollback if the application exception is specified as causing rollback.	Receives AppException. Can attempt to continue computation in the transaction, and eventually commit the transaction unless the application exception is specified as causing rollback (the commit would fail if the instance called <code>setRollbackOnly</code>).
	all other exceptions and errors	Log the exception or error [Note B]. Mark the transaction for rollback. Discard instance [Note C]. Throw <code>javax.ejb.EJBTransactionRolledbackException</code> to client. [Note D]	Receives <code>javax.ejb.EJBTransactionRolledbackException</code> Continuing transaction is fruitless.

Table 15 Handling of Exceptions Thrown by a Business Interface Method or No-interface View Method of a Bean with Container-Managed Transaction Demarcation

Method condition	Method exception	Container's action	Client's view
Bean method runs in the context of a transaction that the container started immediately before dispatching the business method. This case may happen with <code>Required</code> and <code>RequiresNew</code> attributes.	AppException	If the instance called <code>setRollbackOnly()</code> , then rollback the transaction, and re-throw AppException. If the application exception is specified as causing rollback, then rollback the transaction and then re-throw AppException. Otherwise, attempt to commit the transaction, and then re-throw AppException.	Receives AppException. If the client executes in a transaction, the client's transaction is not marked for rollback, and client can continue its work.
	all other exceptions	Log the exception or error. Rollback the container-started transaction. Discard instance. Throw <code>EJBException</code> to client.[Note E]	Receives <code>EJBException</code> . If the client executes in a transaction, the client's transaction may or may not be marked for rollback.
Bean method runs with an unspecified transaction context. This case may happen with the <code>NotSupported</code> , <code>Never</code> , and <code>Supports</code> attributes.	AppException	Re-throw AppException.	Receives AppException. If the client executes in a transaction, the client's transaction is not marked for rollback, and client can continue its work.
	all other exceptions	Log the exception or error. Discard instance. Throw <code>EJBException</code> to client.[Note F]	Receives <code>EJBException</code> . If the client executes in a transaction, the client's transaction may or may not be marked for rollback.

Notes:

- [A] The caller can be another enterprise bean or an arbitrary client program.
- [B] *Log the exception or error* means that the container logs the exception or error so that the System Administrator is alerted of the problem.
- [C] *Discard instance* means that the container must not invoke any business methods or container callbacks on the instance. Discarding does not apply if the bean is a Singleton.
- [D] If the business interface is a remote business interface that extends `java.rmi.Remote`, the `javax.transaction.TransactionRolledbackException` is thrown to the client, which will receive this exception.
- [E] If the business interface is a remote business interface that extends `java.rmi.Remote`, the `java.rmi.RemoteException` is thrown to the client, which will receive this exception.
- [F] If the business interface is a remote business interface that extends `java.rmi.Remote`, the `java.rmi.RemoteException` is thrown to the client, which will receive this exception.

Table 16 specifies how the container must handle the exceptions thrown by the methods of the business interface or No-interface view for beans with bean-managed transaction demarcation, including the exceptions thrown by business method interceptor methods which intercept the invocation of business methods. The table specifies the container's action as a function of the condition under which the business interface method executes and the exception thrown by the method. The table also illustrates the exception that the client will receive and how the client can recover from the exception. (Section 14.4 describes the client's view of exceptions in detail.)

Table 16 Handling of Exceptions Thrown by a Business Interface Method or No-Interface View Method of a Session Bean with Bean-Managed Transaction Demarcation

Bean method condition	Bean method exception	Container action	Client receives
Bean is stateful or stateless or singleton session.	AppException	Re-throw AppException	Receives AppException.
	all other exceptions	Log the exception or error. Rollback a transaction that has been started, but not yet completed, by the instance. Discard instance. [Note A] Throw EJBException to client. [Note B]	Receives EJBException.

Notes:

[A] Discarding not apply if the bean is a Singleton.

[B] If the business interface is a remote business interface that extends java.rmi.Remote, the java.rmi.RemoteException is thrown to the client, which will receive this exception.

14.3.2 Exceptions from Method Invoked via Session or Entity Bean's 2.1 Client View or through Web Service Client View

Business methods in this context are considered to be the methods defined in the enterprise bean's business interface, home interface, component interface, or web service endpoint (including superinterfaces of these); and the following session bean or entity bean methods: `ejbCreate<METHOD>`, `ejbPostCreate<METHOD>`, `ejbRemove`, `ejbHome<METHOD>`, and `ejbFind<METHOD>` methods.

Table 17 specifies how the container must handle the exceptions thrown by the business methods for beans with container-managed transaction demarcation, including the exceptions thrown by business method interceptor methods which intercept the invocation of business methods. The table specifies the container's action as a function of the condition under which the business method executes and the exception thrown by the business method. The table also illustrates the exception that the client will receive and how the client can recover from the exception. (Section 14.4 describes the client's view of exceptions in detail.) The notation "AppException" denotes an application exception.

Table 17 Handling of Exceptions Thrown by Methods of Web Service Client View or EJB 2.1 Client View of a Bean with Container-Managed Transaction Demarcation

Method condition	Method exception	Container's action	Client's view
Bean method runs in the context of the caller's transaction [Note A]. This case may happen with <code>Required</code> , <code>MANDATORY</code> , and <code>SUPPORTS</code> attributes.	AppException	Re-throw AppException Mark the transaction for rollback if the application exception is specified as causing rollback.	Receives AppException. Can attempt to continue computation in the transaction, and eventually commit the transaction unless the application exception is specified as causing rollback (the commit would fail if the instance called <code>setRollbackOnly</code>).
	all other exceptions and errors	Log the exception or error [Note B]. Mark the transaction for rollback. Discard instance [Note C]. Throw <code>javax.transaction.TransactionRolledbackException</code> to remote client; throw <code>javax.ejb.TransactionRolledbackLocalException</code> to local client.	Receives <code>javax.transaction.TransactionRolledbackException</code> OR <code>javax.ejb.TransactionRolledbackLocalException</code> Continuing transaction is fruitless.

Table 17

Handling of Exceptions Thrown by Methods of Web Service Client View or EJB 2.1 Client View of a Bean with Container-Managed Transaction Demarcation

Method condition	Method exception	Container's action	Client's view
Bean method runs in the context of a transaction that the container started immediately before dispatching the business method. This case may happen with <code>Required</code> and <code>RequiresNew</code> attributes.	AppException	If the instance called <code>setRollbackOnly()</code> , then rollback the transaction, and re-throw AppException. If the application exception is specified as causing rollback, then rollback the transaction and then re-throw AppException. Otherwise, attempt to commit the transaction, and then re-throw AppException.	Receives AppException. If the client executes in a transaction, the client's transaction is not marked for rollback, and client can continue its work.
	all other exceptions	Log the exception or error. Rollback the container-started transaction. Discard instance. Throw <code>RemoteException</code> to remote or web service client [Note D]; throw <code>EJBException</code> to local client.	Receives <code>RemoteException</code> or <code>EJBException</code> . If the client executes in a transaction, the client's transaction may or may not be marked for rollback.
Bean method runs with an unspecified transaction context. This case may happen with the <code>NotSupported</code> , <code>Never</code> , and <code>Supports</code> attributes.	AppException	Re-throw AppException.	Receives AppException. If the client executes in a transaction, the client's transaction is not marked for rollback, and client can continue its work.
	all other exceptions	Log the exception or error. Discard instance. Throw <code>RemoteException</code> to remote or web service client; throw <code>EJBException</code> to local client.	Receives <code>RemoteException</code> or <code>EJBException</code> . If the client executes in a transaction, the client's transaction may or may not be marked for rollback.

Notes:

- [A] The caller can be another enterprise bean or an arbitrary client program. This case is not applicable for methods of the web service endpoint.
- [B] *Log the exception or error* means that the container logs the exception or error so that the System Administrator is alerted of the problem.
- [C] *Discard instance* means that the container must not invoke any business methods or container callbacks on the instance. Discarding does not apply if the bean is a Singleton.
- [D] Throw `RemoteException` to web service client means that the container maps the `RemoteException` to the appropriate SOAP fault. See [25].

Table 18 specifies how the container must handle the exceptions thrown by the business methods for beans with bean-managed transaction demarcation, including the exceptions thrown by business method interceptor methods which intercept the invocation of business methods. The table specifies the container's action as a function of the condition under which the business method executes and the exception thrown by the business method. The table also illustrates the exception that the client will receive and how the client can recover from the exception. (Section 14.4 describes the client's view of exceptions in detail.)

Table 18 Handling of Exceptions Thrown by a EJB 2.1 Client View Business Method of a Session Bean with Bean-Managed Transaction Demarcation

Bean method condition	Bean method exception	Container action	Client receives
Bean is stateful or stateless or singleton session.	AppException	Re-throw AppException	Receives AppException.
	all other exceptions	Log the exception or error. Rollback a transaction that has been started, but not yet completed, by the instance. Discard instance.[Note A] Throw RemoteException to remote or web service client [Note B]; throw EJBException to local client.	Receives RemoteException OR EJBException.

Notes:

- [A] Discarding does not apply if the bean is a Singleton.
- [B] Throw RemoteException to web service client means that the container maps the RemoteException to the appropriate SOAP fault. See [25].

14.3.3 Exceptions from PostConstruct and PreDestroy Methods of a Session Bean

Table 19 specifies how the container must handle the exceptions thrown by the `PostConstruct` and `PreDestroy` methods for session beans.

Table 19 Handling of Exceptions Thrown by a `PostConstruct` or `PreDestroy` Method of a Stateful or Stateless or Singleton Session Bean.

Bean method condition	Bean method exception	Container action
Bean is stateful or stateless or singleton session bean	system exceptions	Log the exception or error. If Singleton, rollback any container-started transaction. Discard instance.

14.3.4 Exceptions from Message-Driven Bean Message Listener Methods

This section specifies the container's handling of exceptions thrown from a message-driven bean's message listener method.

Table 20 specifies how the container must handle the exceptions thrown by a message listener method of a message-driven bean with container-managed transaction demarcation, including the exceptions thrown by business method interceptor methods which intercept the invocation of message listener methods. The table specifies the container's action as a function of the condition under which the method executes and the exception thrown by the method.

Table 20 Handling of Exceptions Thrown by a Message Listener Method of a Message-Driven Bean with Container-Managed Transaction Demarcation.

Method condition	Method exception	Container's action
Bean method runs in the context of a transaction that the container started immediately before dispatching the method. This case happens with <code>Required</code> attribute.	<p>AppException</p> <p>Mark the transaction for rollback if the application exception is specified as causing rollback.</p>	<p>If the instance called <code>setRollbackOnly</code>, rollback the transaction and re-throw AppException to resource adapter.</p> <p>Otherwise, attempt to commit the transaction unless the application exception is specified as causing rollback and re-throw AppException to resource adapter.</p>
	system exceptions	<p>Log the exception or error[Note A].</p> <p>Rollback the container-started transaction.</p> <p>Discard instance[Note B].</p> <p>Throw EJBException that wraps the original exception to resource adapter.</p>
Bean method runs with an unspecified transaction context. This case happens with the <code>NotSupported</code> attribute.	AppException	Re-throw AppException to resource adapter.
	system exceptions	<p>Log the exception or error.</p> <p>Discard instance.</p> <p>Throw EJBException that wraps the original exception to resource adapter</p>

Notes:

- [A] *Log the exception or error* means that the container logs the exception or error so that the System Administrator is alerted of the problem.
- [B] *Discard instance* means that the container must not invoke any methods on the instance.

Table 21 specifies how the container must handle the exceptions thrown by a message listener method of a message-driven bean with bean-managed transaction demarcation. The table specifies the container's action as a function of the condition under which the method executes and the exception thrown by the method.

Table 21 Handling of Exceptions Thrown by a Message Listener Method of a Message-Driven Bean with Bean-Managed Transaction Demarcation.

Bean method condition	Bean method exception	Container action
Bean is message-driven bean	AppException	Re-throw AppException to resource adapter.
	system exceptions	Log the exception or error. Rollback a transaction that has been started, but not yet completed, by the instance. Discard instance. Throw EJBException that wraps the original exception to resource adapter.

14.3.5 Exceptions from PostConstruct and PreDestroy Methods of a Message-Driven Bean

Table 22 specifies how the container must handle the exceptions thrown by the `PostConstruct` and `PreDestroy` methods of message-driven beans.

Table 22 Handling of Exceptions Thrown by a PostConstruct or PreDestroy Method of a Message-Driven Bean.

Bean method condition	Bean method exception	Container action
Bean is message-driven bean	system exceptions	Log the exception or error. Discard instance.

14.3.6 Exceptions from an Enterprise Bean's Timeout Callback Method

This section specifies the container's handling of exceptions thrown from an enterprise bean's timeout callback method.

Table 23 and Table 24 specify how the container must handle the exceptions thrown by the timeout callback method of an enterprise bean. The timeout callback method does not throw application exceptions and cannot throw exceptions to the client.

Table 23 Handling of Exceptions Thrown by a Timeout Callback Method of an Enterprise Bean with Container-Managed Transaction Demarcation.

Method condition	Method exception	Container's action
Bean timeout callback method runs in the context of a transaction that the container started immediately before dispatching the method.	system exceptions	Log the exception or error[Note A]. Rollback the container-started transaction. Discard instance[Note B].

Notes:

- [A] *Log the exception or error* means that the container logs the exception or error so that the System Administrator is alerted of the problem.
- [B] *Discard instance* means that the container must not invoke any methods on the instance. Discarding does not apply if the bean is a Singleton.

Table 24 Handling of Exceptions Thrown by a Timeout Callback Method of an Enterprise Bean with Bean-Managed Transaction Demarcation.

Method condition	Method exception	Container's action
The bean timeout callback method may make use of UserTransaction.	system exceptions	Log the exception or error[Note A]. Rollback a transaction that has been started, but not yet completed, by the instance. Discard instance[Note B].

Notes:

- [A] *Log the exception or error* means that the container logs the exception or error so that the System Administrator is alerted of the problem.
- [B] *Discard instance* means that the container must not invoke any methods on the instance. Discarding does not apply if the bean is a Singleton.

14.3.7 Exceptions from Other Container-invoked Callbacks

This subsection specifies the container's handling of exceptions thrown from the other container-invoked callbacks on the enterprise bean. This subsection applies to the following callback methods:

- Dependency injection methods.
- The `ejbActivate`, `ejbLoad`, `ejbPassivate`, `ejbStore`, `setEntityContext`, and `unsetEntityContext` methods of the `EntityBean` interface.
- The `PostActivate` and `PrePassivate` callback methods, and/or `ejbActivate`, `ejbPassivate`, and `setSessionContext` methods of the `SessionBean` interface.
- The `setMessageDrivenContext` method of the `MessageDrivenBean` interface.
- The `afterBegin`, `beforeCompletion` and `afterCompletion` session synchronization methods.

The container must handle all exceptions or errors from these methods as follows:

- Log the exception or error to bring the problem to the attention of the System Administrator.
- If the instance is in a transaction, mark the transaction for rollback.
- Discard the instance (i.e., the container must not invoke any business methods or container callbacks on the instance).
- If the exception or error happened during the processing of a client invoked method, throw the `javax.ejb.EJBException`^[78]. If the EJB 2.1 client view or web service client view is used, throw the `java.rmi.RemoteException` to the client if the client is a remote client or throw the `javax.ejb.EJBException` to the client if the client is a local client. If the instance executed in the client's transaction, the container should throw the `javax.ejb.EJBTransactionRolledbackException`^[79]. If the EJB 2.1 client view or web service client view is used, the container should throw the `javax.transaction.TransactionRolledbackException` to a remote client or the `javax.ejb.TransactionRolledbackLocalException` to a local client, because it provides more information to the client. (The client knows that it is fruitless to continue the transaction.)

14.3.8 javax.ejb.NoSuchEntityException

The `NoSuchEntityException` is a subclass of `EJBException`. If it is thrown by a method of an entity bean class, the container must handle the exception using the rules for `EJBException` described in Sections 14.3.2, 14.3.4, and 14.3.7.

To give the client a better indication of the cause of the error, the container should throw the `java.rmi.NoSuchObjectException` (which is a subclass of `java.rmi.RemoteException`) to a remote client, or the `javax.ejb.NoSuchObjectLocalException` to a local client.

[78] If the business interface is a remote business interface that extends `java.rmi.Remote`, the `java.rmi.RemoteException` is thrown to the client instead.

[79] If the business interface is a remote business interface that extends `java.rmi.Remote`, the `javax.transaction.TransactionRolledbackException` is thrown to the client instead.

14.3.9 Non-existing Stateful Session or Entity Object

If a client makes a call to a stateful session or entity object that has been removed, the container should throw the `javax.ejb.NoSuchEJBException`^[80]. If the EJB 2.1 client view is used, the container should throw the `java.rmi.NoSuchObjectException` (which is a subclass of `java.rmi.RemoteException`) to a remote client, or the `javax.ejb.NoSuchObjectLocalException` to a local client.

14.3.10 Exceptions from the Management of Container-Managed Transactions

The container is responsible for starting and committing the container-managed transactions, as described in Subsection 13.6.2. This subsection specifies how the container must deal with the exceptions that may be thrown by the transaction start and commit operations.

If the container fails to start or commit a container-managed transaction, the container must throw the `javax.ejb.EJBException`^[81]. If the web service client view or EJB 2.1 client view is used, the container must throw the `java.rmi.RemoteException` to a remote or web service client and the `javax.ejb.EJBException` to a local client. In the case where the container fails to start or commit a container-managed transaction on behalf of a message-driven bean or a timeout callback method, the container must throw and log the `javax.ejb.EJBException`.

However, the container should not throw the `javax.ejb.EJBException` or `java.rmi.RemoteException` if the container performs a transaction rollback because the transaction has been marked for rollback and no `EJBException` or `RemoteException` would otherwise be thrown according to sections [14.3.1] through [14.3.9]. In this case, the container must rollback the transaction and pass the business method result or the application exception thrown by the business method to the client.

Note that some implementations of the container may retry a failed transaction transparently to the client and enterprise bean code. Such a container would throw the `javax.ejb.EJBException` or `java.rmi.RemoteException` or after a number of unsuccessful tries.

14.3.11 Release of Resources

When the container discards an instance because of a system exception, the container should release all the resources held by the instance that were acquired through the resource factories declared in the enterprise bean environment (See Subsection 16.7).

[80] If the business interface is a remote business interface that extends `java.rmi.Remote`, the `java.rmi.NoSuchObjectException` is thrown to the client instead.

[81] If the business interface is a remote business interface that extends `java.rmi.Remote`, the `java.rmi.RemoteException` is thrown to the client instead.

Note: While the container should release the connections to the resource managers that the instance acquired through the resource factories declared in the enterprise bean environment, the container cannot, in general, release “unmanaged” resources that the instance may have acquired through the JDK APIs. For example, if the instance has opened a TCP/IP connection, most container implementations will not be able to release the connection. The connection will be eventually released by the JVM garbage collector mechanism.

14.3.12 Support for Deprecated Use of `java.rmi.RemoteException`

The EJB 1.0 specification allowed the business methods, `ejbCreate`, `ejbPostCreate`, `ejbFind<METHOD>`, `ejbRemove`, and the container-invoked callbacks (i.e., the methods defined in the `EntityBean`, `SessionBean`, and `SessionSynchronization` interfaces) implemented in the enterprise bean class to use the `java.rmi.RemoteException` to report non-application exceptions to the container.

This use of the `java.rmi.RemoteException` was deprecated in EJB 1.1—enterprise beans written for the EJB 1.1 specification should use the `javax.ejb.EJBException` instead, and enterprise beans written for the EJB 2.0 or later specification must use the `javax.ejb.EJBException` instead.

The EJB 1.1 and EJB 2.0 or later specifications require that a container support the deprecated use of the `java.rmi.RemoteException`. The container should treat the `java.rmi.RemoteException` thrown by an enterprise bean method in the same way as it is specified for the `javax.ejb.EJBException`.

14.4 Client's View of Exceptions

This section describes the client's view of exceptions received from an enterprise bean invocation.

A client accesses an enterprise bean either through the enterprise bean's business interface (whether local or remote), through the enterprise bean's no-interface view, through the enterprise bean's remote home and remote interfaces, through the enterprise bean's local home and local interfaces, or through the enterprise bean's web service client view depending on whether the client is written to the EJB 3.x API or earlier API and whether the client is a remote client, a local client, or a web service client.

The methods of the business interface typically do not throw the `java.rmi.RemoteException`, regardless of whether the interface is a remote or local interface.

The remote home interface, the remote component interface, and the JAX-RPC web service endpoint interface are Java RMI interfaces, and therefore the `throws` clauses of all their methods (including those inherited from superinterfaces) include the mandatory `java.rmi.RemoteException`. The `throws` clauses may include an arbitrary number of application exceptions.

The local home and local interfaces are both Java local interfaces, and the `throws` clauses of all their methods (including those inherited from superinterfaces) must not include the `java.rmi.RemoteException`. The `throws` clauses may include an arbitrary number of application exceptions.

The no-interface view is a local view, and the `throws` clauses of all its methods must not include the `java.rmi.RemoteException`. The `throws` clauses may include an arbitrary number of application exceptions.

14.4.1 Application Exception

14.4.1.1 Local and Remote Clients

If a client program receives an application exception from an enterprise bean invocation, the client can continue calling the enterprise bean. An application exception does not result in the removal of the EJB object.

Although the container does not automatically mark for rollback a transaction because of a thrown application exception, the transaction might have been marked for rollback by the enterprise bean instance before it threw the application exception or the application exception may have been specified to require the container to rollback the transaction. There are two ways to learn if a particular application exception results in transaction rollback or not:

- Statically. Programmers can check the documentation of the enterprise bean's client view interface. The Bean Provider may have specified (although he or she is not required to) the application exceptions for which the enterprise bean marks the transaction for rollback before throwing the exception.
- Dynamically. Clients that are enterprise beans with container-managed transaction demarcation can use the `getRollbackOnly` method of the `javax.ejb.EJBContext` object to learn if the current transaction has been marked for rollback; other clients may use the `getStatus` method of the `javax.transaction.UserTransaction` interface to obtain the transaction status.

14.4.1.2 Web Service Clients

If a stateless session bean throws an application exception from one of its web service methods, it is the responsibility of the container to map the exception to the SOAP fault specified in the WSDL that describes the port type that the stateless session bean implements. For Java clients, the exceptions received by the client are described by the mapping rules in [25].

14.4.2 java.rmi.RemoteException and javax.ejb.EJBException

As described above, a client receives the `javax.ejb.EJBException` or the `java.rmi.RemoteException` as an indication of a failure to invoke an enterprise bean method or to properly complete its invocation. The exception can be thrown by the container or by the communication subsystem between the client and the container.

If the client receives the `javax.ejb.EJBException` or the `java.rmi.RemoteException` exception from a method invocation, the client, in general, does not know if the enterprise bean's method has been completed or not.

If the client executes in the context of a transaction, the client's transaction may, or may not, have been marked for rollback by the communication subsystem or target bean's container.

For example, the transaction would be marked for rollback if the underlying transaction service or the target bean's container doubted the integrity of the data because the business method may have been partially completed. Partial completion could happen, for example, when the target bean's method returned with a `RuntimeException` exception, or if the remote server crashed in the middle of executing the business method.

The transaction may not necessarily be marked for rollback. This might occur, for example, when the communication subsystem on the client-side has not been able to send the request to the server.

When a client executing in a transaction context receives an `EJBException` or a `RemoteException` from an enterprise bean invocation, the client may use either of the following strategies to deal with the exception:

- Discontinue the transaction. If the client is the transaction originator, it may simply rollback its transaction. If the client is not the transaction originator, it can mark the transaction for rollback or perform an action that will cause a rollback. For example, if the client is an enterprise bean, the enterprise bean may throw a `RuntimeException` which will cause the container to rollback the transaction.
- Continue the transaction. The client may perform additional operations on the same or other enterprise beans, and eventually attempt to commit the transaction. If the transaction was marked for rollback at the time the `EJBException` or `RemoteException` was thrown to the client, the commit will fail.

If the client chooses to continue the transaction, the client can first inquire about the transaction status to avoid fruitless computation on a transaction that has been marked for rollback. A client that is an enterprise bean with container-managed transaction demarcation can use the `EJBContext.getRollbackOnly` method to test if the transaction has been marked for rollback; a client that is an enterprise bean with bean-managed transaction demarcation, and other client types, can use the `UserTransaction.getStatus` method to obtain the status of the transaction.

Some implementations of EJB servers and containers may provide more detailed exception reporting by throwing an appropriate subclass of the `javax.ejb.EJBException` or `java.rmi.RemoteException` to the client. The following subsections describe the several subclasses of the `javax.ejb.EJBException` and `java.rmi.RemoteException` that may be thrown by the container to give the client more information.

14.4.2.1 `javax.ejb.EJBTransactionRolledbackException`, `javax.ejb.TransactionRolledbackLocalException`, and `javax.transaction.TransactionRolledbackException`

The `javax.ejb.EJBTransactionRolledbackException` and `javax.ejb.TransactionRolledbackLocalException` are subclasses of the `javax.ejb.EJBException`. The `javax.transaction.TransactionRolledbackException` is a subclass of the `java.rmi.RemoteException`. It is defined in the JTA standard extension.

If a client receives one of these exceptions, the client knows for certain that the transaction has been marked for rollback. It would be fruitless for the client to continue the transaction because the transaction can never commit.

14.4.2.2 **javax.ejb.EJBTransactionRequiredException, javax.ejb.TransactionRequiredLocalException, and javax.transaction.TransactionRequiredException**

The `javax.ejb.EJBTransactionRequiredException` and `javax.ejb.TransactionRequiredLocalException` are subclasses of the `javax.ejb.EJBException`. The `javax.transaction.TransactionRequiredException` is a subclass of the `java.rmi.RemoteException`. It is defined in the JTA standard extension.

The `javax.ejb.EJBTransactionRequiredException`, `javax.ejb.TransactionRequiredLocalException`, or `javax.transaction.TransactionRequiredException` informs the client that the target enterprise bean must be invoked in a client's transaction, and that the client invoked the enterprise bean without a transaction context.

This error usually indicates that the application was not properly formed.

14.4.2.3 **javax.ejb.NoSuchEJBException, javax.ejb.NoSuchObjectLocalException, and java.rmi.NoSuchObjectException**

The `javax.ejb.NoSuchEJBException` is a subclass of the `javax.ejb.EJBException`. It is thrown to the client of a session bean's business interface if a local business method cannot complete because the EJB object no longer exists.

The `javax.ejb.NoSuchObjectLocalException` and the `java.rmi.NoSuchObjectException` apply to the business methods of the EJB 2.1 local and remote client views respectively.

- The `javax.ejb.NoSuchObjectLocalException` is a subclass of the `javax.ejb.EJBException`. It is thrown to the client if a local business method cannot complete because the EJB object no longer exists.
- The `java.rmi.NoSuchObjectException` is a subclass of the `java.rmi.RemoteException`. It is thrown to the client if a remote business method cannot complete because the EJB object no longer exists.

14.5 System Administrator's Responsibilities

The System Administrator is responsible for monitoring the log of the non-application exceptions and errors logged by the container, and for taking actions to correct the problems that caused these exceptions and errors.

Support for Distributed Interoperability

This chapter describes the interoperability support for accessing an enterprise bean through the EJB 2.1 remote client view from clients distributed over a network, and the distributed interoperability requirements for invocations on enterprise beans from remote clients that are Java Platform, Enterprise Edition (Java EE) components. Distributed Interoperability is not defined for the EJB 3.x remote client view.

15.1 Support for Distribution

The remote home and remote interfaces of an enterprise bean's remote client view are defined as Java™ RMI [6] interfaces. This allows the container to implement the remote home and remote interfaces as *distributed objects*. A client using the remote home and remote interfaces can reside on a different machine than the enterprise bean (location transparency), and the object references of the remote home and remote interfaces can be passed over the network to other applications.

The EJB specification further constrains the Java RMI types that can be used by enterprise beans to be legal RMI-IIOP types [10]. This makes it possible for EJB container implementors to use RMI-IIOP as the object distribution protocol.

15.1.1 Client-Side Objects in a Distributed Environment

When the RMI-IIOP protocol or similar distribution protocols are used, the remote client communicates with the enterprise bean using *stubs* for the server-side objects. The stubs implement the remote home and remote interfaces.

Figure 32 Location of EJB Client Stubs.

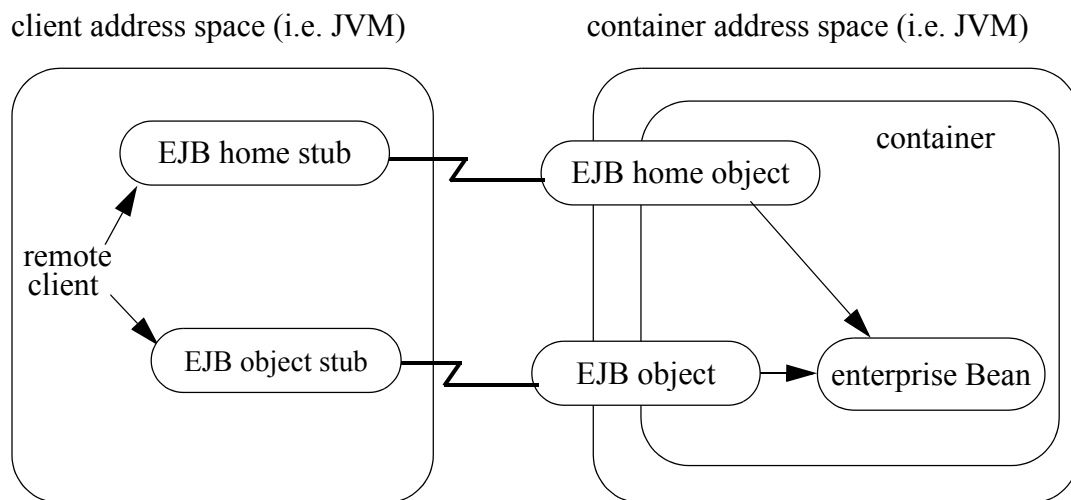

The communication stubs used on the client side are artifacts generated at the enterprise bean's deployment time by the Container Provider's tools. The stubs used on the client are specific to the wire protocol used for the remote invocation.

15.2 Interoperability Overview

Session beans and entity beans that are deployed in one vendor's server product may need to be accessed from Java EE client components that are deployed in another vendor's product through the remote client view. EJB defines a standard interoperability protocol based on CORBA/IIOP to address this need.

The interoperability protocols described here must be supported by compatible EJB products. Additional vendor-specific protocols may also be supported.

Figure 33 shows a heterogeneous environment that includes systems from several vendors to illustrate the interoperability enabled by EJB.

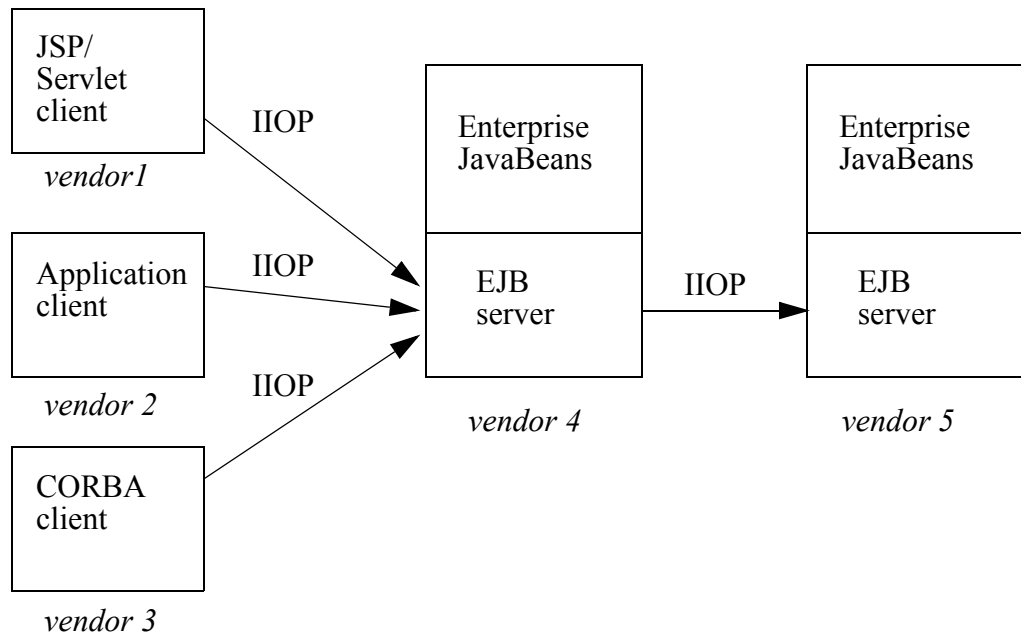
Figure 33 Heterogeneous EJB Environment

The following sections in this chapter

- describe the goals for EJB invocation interoperability
- provide illustrative scenarios
- describe the interoperability requirements for remote invocations, transactions, naming, and security.

15.2.1 Interoperability Goals

The goals of the interoperability requirements specified in this chapter are as follows:

- To allow clients in one application deployed in Java EE containers from one server provider to access services from session and entity beans in another application that is deployed in an EJB container from a different server provider. For example, web components (JavaServer Pages and servlets) that are deployed on a Java EE compliant web server provided by one server provider must be able to invoke the business methods of enterprise beans that are deployed on a Java EE compliant EJB server from another server provider.

- To achieve interoperability without any new requirements on the Java EE application developer.
- To ensure out-of-the-box interoperability between compliant Java EE products. It must be possible for an enterprise customer to install multiple Java EE server products from different server providers (on potentially different operating systems), deploy applications in the Java EE servers, and have the multiple applications interoperate.
- To leverage the interoperability work done by standards bodies (including the IETF, W3C, and OMG) where possible, so that customers can work with industry standards and use standard protocols to access enterprise beans.

This specification does not address interoperability issues between enterprise beans and non-Java-EE components. The Java EE platform specification [12] and the JAX-RPC and JAX-WS specifications [25], [32] describe requirements for interoperability with Internet clients (using HTTP and XML) and interoperability with enterprise information systems (using the Connector architecture [15]).

Since the interoperability protocol described here is based on CORBA/IIOP, CORBA clients written in Java, C++, or other languages can also invoke methods on enterprise beans.

This chapter subsumes the previous EJB1.1-to-CORBA mapping document [16].

15.3 Interoperability Scenarios

This section presents a number of interoperability scenarios that motivate the interoperability mechanisms described in later sections of this chapter. These scenarios are illustrative rather than prescriptive. This section does not specify requirements for a Java EE product to support these scenarios in exactly the manner described here.

Java EE applications are multi-tier, web-enabled applications. Each application consists of one or more components, which are deployed in containers. The four types of containers are:

- EJB containers, which host enterprise beans.
- Web containers, which host JavaServer Pages (JSPs) and servlet components as well as static documents, including HTML pages.
- Application client containers, which host standalone applications.
- Applet containers, which host applets which may be downloaded from a web site. At this time, there is no requirement for an applet to be able to directly invoke the remote methods of enterprise beans.

The scenarios below describe interactions between components hosted in these various container types.

15.3.1 Interactions Between Web Containers and EJB Containers for E-Commerce

Applications

This scenario occurs for business-to-business and business-to-consumer interactions over the Internet.

Scenario 1: *A customer wants to buy a book from an Internet bookstore. The bookstore's web site consists of a Java EE application containing JSPs that form the presentation layer, and another Java EE application containing enterprise beans that have the business logic and database access code. The JSPs and enterprise beans are deployed in containers from different vendors.*

At deployment time: *The enterprise beans are deployed, and their EJBHome objects are published in the EJB server's name service. The Deployer links the EJB reference in the JSP's deployment descriptor to the URL of the enterprise bean's EJBHome object, which can be looked up from the name service. The transaction attribute specified in the enterprise bean's deployment descriptor is `RequiresNew` for all business methods. Because the "checkout" JSP requires secure access to set up payments for purchases, the bookstore's administrator configures the "checkout" JSP to require access over HTTPS with only server authentication. Customer authentication is done using form-based login. The "book search" JSP is accessed over normal HTTP. Both JSPs talk with enterprise beans that access the book database. The web and EJB containers use the same customer realm and have a trust relationship with each other. The network between the web and EJB servers is not guaranteed to be secure from attacks.*

At runtime: *The customer accesses the book search JSP using a browser. The JSP looks up the enterprise bean's EJBHome object in a name service, and calls `findBooks(...)` with the search criteria as parameters. The web container establishes a secure session with the EJB container with mutual authentication between the containers, and invokes the enterprise bean. The customer then decides to buy a book, and accesses the "checkout" JSP. The customer enters the necessary information in the login form, which is used by the web server to authenticate the customer. The JSP invokes the enterprise bean to update the book and customer databases. The customer's principal is propagated to the EJB container and used for authorization checks. The enterprise bean completes the updates and commits the transaction. The JSP sends back a confirmation page to the customer.*

15.3.2 Interactions Between Application Client Containers and EJB Containers Within an Enterprise's Intranet

Scenario 2.1: *An enterprise has an expense accounting application used by employees from their desktops. The server-side consists of a Java EE application containing enterprise beans that are deployed on one vendor's Java EE product, which is hosted in a datacenter. The client side consists of another Java EE application containing an application client deployed using another vendor's Java EE infrastructure. The network between the application client and the EJB container is insecure and needs to be protected against spoofing and other attacks.*

At deployment time: *The enterprise beans are deployed and their EJBHome objects are published in the enterprise's name service. The application clients are configured with the names of the EJBHome objects. The Deployer maps employees to roles that are allowed access to the enterprise beans. The System Administrator configures the security settings of the application client and EJB container to use client and server authentication and message protection. The System Administrator also does the necessary client-side configuration to allow client authentication.*

***At runtime:** The employee logs on using username and password. The application client container may interact with the enterprise's authentication service infrastructure to set up the employee's credentials. The client application does a remote invocation to the name server to look up the enterprise bean's EJB-Home object, and creates the enterprise beans. The application client container uses a secure transport protocol to interact with the name server and EJB server, which does mutual authentication and also guarantees the confidentiality and integrity of messages. The employee then enters the expense information and submits it. This causes remote business methods of the enterprise beans to be invoked. The EJB container performs authorization checks and, if they succeed, executes the business methods.*

***Scenario 2.2:** This is the same as Scenario 2.1, except that there is no client-side authentication infrastructure set up by the System Administrator which can authenticate at the transport protocol layer. At runtime the client container needs to send the user's password to the server during the method invocation to authenticate the employee.*

15.3.3 Interactions Between Two EJB Containers in an Enterprise's Intranet

***Scenario 3:** An enterprise has an expense accounting application which needs to communicate with a payroll application. The applications use enterprise beans and are deployed on Java EE servers from different vendors. The Java EE servers and naming/authentication services may be in the enterprise's datacenter with a physically secure private network between them, or they may need to communicate across the intranet, which may be less secure. The applications need to update accounts and payroll databases. The employee (client) accesses the expense accounting application as described in Scenario 2.*

***At deployment time:** The Deployer configures both applications with the appropriate database resources. The accounts application is configured with the name of the EJBHome object of the payroll application. The payroll bean's deployment descriptor specifies the RequiresNew transaction attribute for all methods. The applications use the same principal-to-role mappings (e.g. the roles may be Employee, PayrollDept, AccountsDept). The Deployer of these two applications has administratively set up a trust relationship between the two EJB containers, so that the containers do not need to authenticate principals propagated on calls to enterprise beans from the other container. The System Administrator also sets up the message protection parameters of the two containers if the network is not physically secure.*

***At runtime:** An employee makes a request to the accounts application which requires it to access the payroll application. The accounts application does a lookup of the payroll application's EJBHome object in the naming/directory service and creates enterprise beans. It updates the accounts database and invokes a remote method of the payroll bean. The accounts bean's container propagates the employee's principal on the method call. The payroll bean's container maps the propagated employee principal to a role, does authorization checks, and sets up the payroll bean's transaction context. The container starts a new transaction, then the payroll bean updates the payroll database, and the container commits the transaction. The accounts bean receives a status reply from the payroll bean. If an error occurs in the payroll bean, the accounts bean executes code to recover from the error and restore the databases to a consistent state.*

15.3.4 Intranet Application Interactions Between Web Containers and EJB Containers

***Scenario 4:** This is the same as scenario 2.1, except that instead of using a “fat-client” desktop application to access the enterprise’s expense accounting application, employees use a web browser and connect to a web server in the intranet that hosts JSPs. The JSPs gather input from the user (e.g., through an HTML form), invoke enterprise beans that contain the actual business logic, and format the results returned by the enterprise beans (using HTML).*

***At deployment time:** The enterprise Deployer configures its expense accounting JSPs to require access over HTTPS with mutual authentication. The web and EJB containers use the same customer realm and have a trust relationship with each other.*

***At run-time:** The employee logs in to the client desktop, starts the browser, and accesses the expense accounting JSP. The browser establishes an HTTPS session with the web server. Client authentication is performed (for example) using the employee’s credentials which have been established by the operating system at login time (the browser interacts with the operating system to obtain the employee’s credentials). The JSP looks up the enterprise bean’s EJBHome object in a name service. The web container establishes a secure session with the EJB container with mutual authentication and integrity/confidentiality protection between the containers, and invokes methods on the enterprise beans.*

15.4 Overview of Interoperability Requirements

The interoperability requirements used to support the above scenarios are:

1. Remote method invocation on an enterprise bean’s EJBObject and EJBHome object references (scenarios 1,2,3,4), described in section 15.5.
2. Name service lookup of the enterprise bean’s EJBHome object (scenarios 1,2,3,4), described in section 15.7.
3. Integrity and confidentiality protection of messages (scenarios 1,2,3,4), described in section 15.8.
4. Authentication between an application client and EJB container (described in section 15.8):
 - 4.1 Mutual authentication at the transport protocol layer when there is client-side authentication infrastructure such as certificates (scenario 2.1).
 - 4.2 Transfer of the user’s authentication data from application client to EJB container to allow the EJB container to authenticate the client when there is no client-side authentication infrastructure (scenario 2.2).
5. Mutual authentication between two EJB containers or between a web and EJB container to establish trust before principals are propagated (scenarios 1,3,4), described in section 15.8.

6. Propagation of the Internet or intranet user's principal name for invocations on enterprise beans from web or EJB containers when the client and server containers have a trust relationship (scenarios 1,3,4), described in section 15.8.

EJB, web, and application client containers must support the above requirements separately as well as in combinations.

15.5 Remote Invocation Interoperability

This section describes the interoperability mechanisms that enable remote invocations on EJBObject and EJBHome object references when client containers and EJB containers are provided by different vendors. This is needed to satisfy interoperability requirement (1) in section 15.4.

All EJB, web, and application client containers must support the IOP 1.2 protocol for remote invocations on EJBObject and EJBHome references. EJB containers must be capable of servicing IOP 1.2 based invocations on EJBObject and EJBHome objects. IOP 1.2 is part of the CORBA 2.3.1 specification [17] from the OMG^[82]. Containers may additionally support vendor-specific protocols.

CORBA Interoperable Object References (IORs) for EJBObject and EJBHome object references must include the GIOP version number 1.2. The IOP infrastructure in all Java EE containers must be able to accept fragmented GIOP messages, although sending fragmented messages is optional. Bidirectional GIOP messages may optionally be supported by Java EE clients and servers: if a Java EE server receives an IOP message from a client which contains the `BiDirIOPServiceContext` structure, it may or may not use the same connection for sending requests back to the client.

Since Java applications use Unicode characters by default, Java EE containers are required to support the Unicode UTF16 code set for transmission of character and string data (in the IDL `wchar` and `wstring` datatypes). Java EE containers may optionally support additional code sets. EJBObject and EJBHome IORs must have the `TAG_CODE_SETS` tagged component which declares the codesets supported by the EJB container. IOP messages which include `wchar` and `wstring` datatypes must have the code sets service context field. The CORBA 2.3.1 requirements for code set support must be followed by Java EE containers.

EJB containers are required to translate Java types to their on-the-wire representation in IOP messages using the Java Language to IDL mapping specification [10] with the wire formats for IDL types as described in the GIOP specification in CORBA 2.3. The following subsections describe the mapping details for Java types.

[82] CORBA APIs and earlier versions of the IOP protocol are already included in the J2SE 1.2, J2SE 1.3 and J2EE 1.2 platforms through JavaIDL and RMI-IOP.

15.5.1 Mapping Java Remote Interfaces to IDL

The Java Language to IDL Mapping specification [10] describes precisely how the remote home and remote interfaces of a session bean or entity bean are mapped to IDL. This mapping to IDL is typically implicit when Java RMI over IIOP is used to invoke enterprise beans. Java EE clients use only the Java RMI APIs to invoke enterprise beans. The client container may use the CORBA portable Stub APIs for the client-side stubs. EJB containers may create CORBA Tie objects for each EJBObject or EJBHome object.

15.5.2 Mapping Value Objects to IDL

The Java interfaces that are passed by value during remote invocations on enterprise beans are `javax.ejb.Handle`, `javax.ejb.HomeHandle`, and `javax.ejb.EJBMetaData`. The Enumeration or Collection objects returned by entity bean finder methods are value types. There may also be application-specific value types that are passed as parameters or return values on enterprise bean invocations. In addition, several Java exception classes that are thrown by remote methods also result in concrete IDL value types. All these value types are mapped to IDL abstract value types or abstract interfaces using the rules in the Java Language to IDL Mapping.

15.5.3 Mapping of System Exceptions

Java system exceptions, including the `java.rmi.RemoteException` and its subclasses, may be thrown by the EJB container. If the client's invocation was made over IIOP, the EJB server is required to map these exceptions to CORBA system exceptions and send them in the IIOP reply message to the client, as specified in the following table

System exception thrown by EJB container	CORBA system exception received by client ORB
<code>javax.transaction.TransactionRolledbackException</code>	TRANSACTION_ROLLEDBACK
<code>javax.transaction.TransactionRequiredException</code>	TRANSACTION_REQUIRED
<code>javax.transaction.InvalidTransactionException</code>	INVALID_TRANSACTION
<code>java.rmi.NoSuchObjectException</code>	OBJECT_NOT_EXIST
<code>java.rmi.AccessException</code>	NO_PERMISSION
<code>java.rmi.MarshalException</code>	MARSHAL
<code>java.rmi.RemoteException</code>	UNKNOWN

For EJB clients, the ORB's unmarshaling machinery maps CORBA system exceptions received in the IIOP reply message to the appropriate Java exception as specified in the Java Language to IDL mapping. This results in the original Java exception being received by the client Java EE component.

15.5.4 Obtaining Stub and Client View Classes

When a Java EE component (application client, JSP, servlet or enterprise bean) receives a reference to an EJBObject or EJBHome object through JNDI lookup or as a parameter or return value of an invocation on an enterprise bean, an instance of an RMI-IIOP stub class (proxy) for the enterprise bean's remote home or remote RMI interface needs to be created. When a component receives a value object as a parameter or return value of an enterprise bean invocation, an instance of the value class needs to be created. The stub class, value class, and other client view classes must be available to the referencing container (the container hosting the component that receives the reference or value type).

The client view classes, including application value classes, must be packaged with the referencing component's application, as described in Section 20.3.

Stubs for invoking on EJBHome and EJBObject references must be provided by the referencing container, for example, by generating stub classes at deployment time for the EJBHome and EJBObject interfaces of the referenced beans that are packaged with the referencing component's application. Stub classes may or may not follow the standard RMI-IIOP portable stub architecture.

Containers may optionally support run-time downloading of stub and value classes needed by the referencing container. The CORBA 2.3.1 specification and the Java Language to IDL Mapping specify how stub and value type implementations are to be downloaded: using codebase URLs that are either embedded in the EJBObject or EJBHome's IOR, or sent in the IIOP message service context, or marshalled with the value type. The URLs for downloading may optionally include an HTTPS URL for secure downloading.

15.5.5 System Value Classes

System value classes are serializable value classes implementing the `javax.ejb.Handle`, `javax.ejb.HomeHandle`, `javax.ejb.EJBMetaData`, `java.util.Enumeration`, `java.util.Collection`, and `java.util.Iterator` interfaces. These value classes are provided by the EJB container vendor. They must be provided in the form of a JAR file by the container hosting the referenced bean. For interoperability scenarios, if a referencing component would use such system value classes at runtime, the Deployer must ensure that these system value classes provided by the container hosting the referenced bean are available to the referencing component. This may be done, for example, by including these system value classes in the classpath of the referencing container, or by deploying the system value classes with the referencing component's application by providing them to the deployment tool.

Implementations of these system value classes must be portable (they must use only J2SE and Java EE APIs) so that they can be instantiated in another vendor's container. If the system value class implementation needs to load application-specific classes (such as remote home or remote interfaces) at runtime, it must use the thread context class loader. The referencing container must make application-specific classes available to the system value class instance at runtime through the thread context class loader.

15.5.5.1 HandleDelegate SPI

The `javax.ejb.spi.HandleDelegate` service provider interface defines methods that enable portable implementations of `Handle` and `HomeHandle` that are instantiated in a different vendor's container to serialize and deserialize `EJBObject` and `EJBHome` references. The `HandleDelegate` interface is not used by enterprise beans or Java EE application components directly.

EJB, web and application client containers must provide implementations of the `HandleDelegate` interface. The `HandleDelegate` object must be accessible in the client Java EE component's JNDI namespace at the reserved name "`java:comp/HandleDelegate`". The `HandleDelegate` object is not exported outside the container that provides it.

Portable implementations of `Handle` and `HomeHandle` must look up the `HandleDelegate` object of the container in which they are instantiated using JNDI at the name "`java:comp/HandleDelegate`" and use the `HandleDelegate` object to serialize and deserialize `EJBObject` and `EJBHome` references as follows:

- `Handle` and `HomeHandle` implementation classes must define `writeObject` and `readObject` methods to control their serialization and deserialization. These methods must not wrap or substitute the stream objects that are passed to the `HandleDelegate` methods.
- The `writeObject` method of `Handle` implementations must call `HandleDelegate.writeEJBObject` with the `Handle`'s `EJBObject` reference and the serialization output stream object as parameters. The `HandleDelegate` implementation (which is provided by the client container in which the `Handle` was instantiated, potentially from a different vendor) then writes the `EJBObject` to the output stream. If the output stream corresponds to an IIOP message, the `HandleDelegate` must use the standard IIOP abstract interface format for writing the `EJBObject` reference.
- The `readObject` method of `Handle` implementations must call `HandleDelegate.readEJBObject` with the serialization input stream object as parameter, and with the stream positioned at the location where the `EJBObject` can be read. The `HandleDelegate` implementation then reads the `EJBObject` from the input stream and returns it to the `Handle`. If the input stream corresponds to an IIOP message, the `HandleDelegate` must use the standard abstract interface format for reading the `EJBObject` reference. The `HandleDelegate` must ensure that the `EJBObject` reference is capable of performing invocations immediately after deserialization. The `Handle` maintains a reference to the `EJBObject` as a transient instance variable and returns it when the Java EE component calls `Handle.getEJBObject`.
- The `writeObject` and `readObject` methods of `HomeHandle` implementation classes must be implemented similarly, by using `HandleDelegate.writeEJBHome` and `HandleDelegate.readEJBHome` respectively.

15.6 Transaction Interoperability

Transaction interoperability between containers provided by different vendors is an optional feature in this version of the EJB specification. Vendors may choose to not implement transaction interoperability. However, vendors who choose to implement transaction interoperability must follow the requirements in sections 15.6.1 and 15.6.2, and vendors who choose not to implement transaction interoperability must follow the requirements in section 15.6.2.

15.6.1 Transaction Interoperability Requirements

A distributed transaction started by a web or EJB container must be able to propagate in a remote invocation to an enterprise bean in an EJB container provided by a different vendor, and the containers must participate in the distributed two-phase commit protocol.

15.6.1.1 Transaction Context Wire Format

Transaction context propagation from client to EJB container uses the implicit propagation mechanism described in the CORBA Object Transaction Service (OTS) v1.2 specification [11].

The transaction context format in IIOP messages is specified in the `CosTransactions::PropagationContext` structure described in the OTS specification. EJB containers that support transaction interoperability are required to be capable of producing and consuming transaction contexts in IIOP messages in the format described in the OTS specification. Web containers that support transaction interoperability are required to include client-side libraries which can produce the OTS transaction context for sending over IIOP.

Note that it is not necessary for containers to include the Java mappings of the OTS APIs. A container may implement the requirements in the OTS specification in any manner, for example using a non-Java OTS implementation, or an on-the-wire bridge between an existing transaction manager and the OTS protocol, or an OTS wrapper around an existing transaction manager.

The `CosTransactions::PropagationContext` structure must be included in IIOP messages sent by web or EJB containers when required by the rules described in the OTS 1.2 specification. The target EJB container must process IIOP invocations based on the transaction policies of `EJBObject` or `EJBHome` references using the rules described in the OTS 1.2 specification [11].

15.6.1.2 Two-Phase Commit Protocol

The object interaction diagram in Figure 34 illustrates the interactions between the client and server transaction managers for transaction context propagation, resource and synchronization object registration, and two-phase commit. This diagram is an example of the interactions between the various entities; it is not intended to be prescriptive.

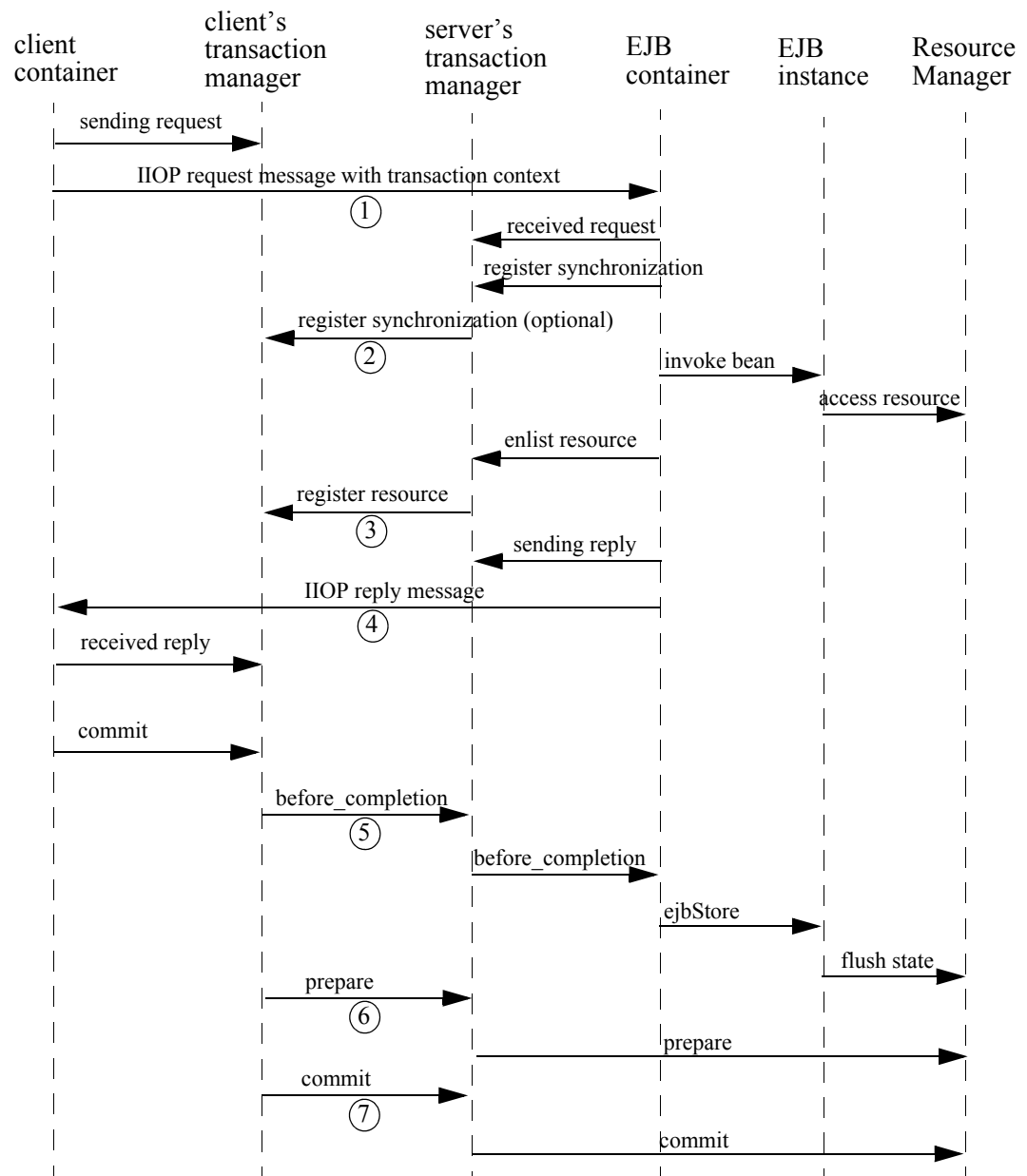
Figure 34 Transaction Context Propagation

Containers that perform transactional work within the scope of a transaction must register an OTS Resource object with the transaction coordinator whose object reference is included in the propagated transaction context (step 3), and may also register an OTS Synchronization object (step 2). If the server container does not register an OTS Synchronization object, it must still ensure that the `beforeCompletion` method of session beans and `ejbStore` method of entity beans are called with the proper transaction context. Containers must participate in the two-phase commit and recovery procedures performed by the transaction coordinator / terminator (steps 6,7), as described by the OTS specification.

Compliant Java EE containers must not use nested transactions in interoperability scenarios.

15.6.1.3 Transactional Policies of Enterprise Bean References

The OTS1.2 specification describes the `CosTransactions::OTSPolicy` and `CosTransactions::InvocationPolicy` structures that are encoded in IORs as tagged components. EJBObject and EJBHome references must contain these tagged components^[83] with policy values as described below.

The transaction attributes of enterprise beans can be specified per method, while in OTS the entire CORBA object has the same OTS transaction policy. The rules below ensure that the transaction context will be propagated if any method of an enterprise bean needs to execute in the client's transaction context. However, in some cases there may be extra performance overhead of propagating the client's transaction context even if it will not be used by the enterprise bean method.

EJBObject and EJBHome references may have the `InvocationPolicy` value as either `CosTransactions::SHARED` or `CosTransactions::EITHER`^[84].

All EJBObject and EJBHome references must have the `OTSPolicy` value as `CosTransactions::ADAPTS`. This is necessary to allow clients to invoke methods of the `javax.ejb.EJBObject` and `javax.ejb.EJBHome` with or without a transaction.

The `CosTransactions::Synchronization` object registered by the EJB container with the transaction coordinator should have the `OTSPolicy` value `CosTransactions::ADAPTS` and `InvocationPolicy` value `CosTransactions::SHARED` to allow enterprise beans to do transactional work during the `beforeCompletion` notification from the transaction coordinator.

15.6.1.4 Exception Handling Behavior

The exception handling behavior described in the OTS1.2 specification must be followed. In particular, if an application exception (an exception which is not a CORBA system exception and does not extend `java.rmi.RemoteException`) is returned by the server, the request is defined as being successful; hence the client-side OTS library must not roll back the transaction. This allows application exceptions to be propagated back to the client without rolling back the transaction, as required by the exception handling rules in Chapter 14.

15.6.2 Interoperating with Containers that do not Implement Transaction

[83] One way to include the tagged components in IORs is to create the object references using a Portable Object Adapter (POA) which is initialized with the appropriate transaction policies. Note that POA APIs are not required to be supported by server containers.

[84] If the `InvocationPolicy` is not present in the IOR, it is interpreted by the client as if the policy value was `CosTransactions::EITHER`.

Interoperability

The requirements in this subsection are designed to ensure that when a Java EE container does not support transaction interoperability, the failure modes are well defined so that the integrity of an application's data is not compromised: at worst the transaction is rolled back. When a Java EE client component expects the client's transaction to propagate to the enterprise bean but the client or EJB container cannot satisfy this expectation, a `java.rmi.RemoteException` or subclass is thrown, which ensures that the client's transaction will roll back.

In addition, the requirements below allow a container that does not support transaction propagation to interoperate with a container that does support transaction propagation in the cases where the enterprise bean method's transaction attribute indicates that the method would not be executed in the client's transaction.

15.6.2.1 Client Container Requirements

If the client in another container invokes an enterprise bean's method when there is no active global transaction associated with the client's thread, the client container does not include a transaction context in the IIOP request message to the EJB server, i.e., there is no `CosTransactions::PropagationContext` structure in the IIOP request header.

The client application component expects a global transaction to be propagated to the server only if the client's thread has an active global transaction. In this scenario, if the client container does not support transaction interoperability, it has two options:

1. If the client container does not support transaction propagation or uses a non-OTS protocol, it must include the OTS `CosTransactions::PropagationContext` structure in the IIOP request to the server (step 1 in the object interaction diagram above), with the `CosTransactions::Coordinator` and `CosTransactions::Terminator` object references as null. The remaining fields in this "null transaction context," such as the transaction identifier, are not interpreted and may have any value. The "null transaction context" indicates that there is a global client transaction active but the client container is not capable of propagating it to the server. The presence of this "null transaction context" allows the EJB container to determine whether the Java EE client component expects the client's global transaction to propagate to the server.
2. Client containers that use the OTS transaction context format but still do not support transaction interoperability with other vendor's containers must reject the `Coordinator::register_resource` call (step 3 in the object interaction diagram above) by throwing a `CORBA_system` exception if the server's `Resource` object reference indicates that it belongs to another vendor's container.

15.6.2.2 EJB container requirements

All EJB containers (including those that do not support transaction propagation) must include the `CosTransactions::OTSPolicy` and optionally the `CosTransactions::InvocationPolicy` tagged component in the IOR for `EJBObject` and `EJBHome` references as described in section 15.6.1.3.

15.6.2.2.1 Requirements for EJB Containers Supporting Transaction Interoperability

When an EJB container that supports transaction propagation receives the IIOP request message, it must behave as follows:

- If there is no OTS transaction context in the IIOP message, the container must follow the behavior described in Section 13.6.
- If there is a valid, complete OTS transaction context in the IIOP message, the container must follow the behavior described in Section 13.6.
- If there is a null transaction context (as defined in section 15.6.2.1 above) in the IIOP message, the container's required behavior is described in the table below. The entry "throw RemoteException" indicates that the EJB container must throw the `java.rmi.RemoteException` to the client after the "received request" interaction with the server's transaction manager (after step 1 in the object interaction diagram above).

EJB method's Transaction Attribute	EJB container behavior on receiving null OTS transaction context
Mandatory	throw RemoteException
Required	throw RemoteException
RequiresNew	follow Section 13.6
Supports	throw RemoteException
NotSupported	follow Section 13.6
Never	follow Section 13.6
Bean Managed	follow Section 13.6

15.6.2.2.2 Requirements for EJB Containers not Supporting Transaction Interoperability

When an EJB container that does not support transaction interoperability receives the IIOP request message, it must behave as follows:

- If there is no OTS transaction context in the IIOP message, the container must follow the behavior described in Section 13.6.
- If there is a valid, complete OTS transaction context in the IIOP message, the container's required behavior is described in the table below.

- If there is a null transaction context (as defined in section 15.6.2.1) in the IIOP message, the container's required behavior is described in the table below. Note that the container may not know whether the received transaction context in the IIOP message is valid or null.

EJB method's Transaction Attribute	EJB container behavior on receiving null or valid OTS transaction context
Mandatory	throw RemoteException
Required	throw RemoteException
RequiresNew	follow Section 13.6
Supports	throw RemoteException
NotSupported	follow Section 13.6
Never	follow Section 13.6
Bean Managed	follow Section 13.6

EJB containers that accept the OTS transaction context format but still do not support interoperability with other vendors' client containers must follow the column in the table above for "null or valid OTS transaction context" if the transaction identity or the Coordinator object reference in the propagated client transaction context indicate that the client belongs to a different vendor's container.

15.7 Naming Interoperability

This section describes the requirements for supporting interoperable access to naming services for looking up EJBHome object references (interoperability requirement two in section 15.4).

EJB containers are required to be able to publish EJBHome object references in a CORBA CosNaming service [18]. The CosNaming service must implement the IDL interfaces in the CosNaming module defined in [18] and allow clients to invoke the `resolve` and `list` operations over IIOP.

The CosNaming service must follow the requirements in the CORBA Interoperable Name Service specification [19] for providing the host, port, and object key for its root `NamingContext` object. The CosNaming service must be able to service IIOP invocations on the root `NamingContext` at the advertised host, port, and object key.

Client containers (i.e., EJB, web, or application client containers) are required to include a JNDI CosNaming service provider that uses the mechanisms defined in the Interoperable Name Service specification to contact the server's CosNaming service, and to resolve the EJBHome object using standard CosNaming APIs. The JNDI CosNaming service provider may or may not use the JNDI SPI architecture. The JNDI CosNaming service provider must access the root `NamingContext` of the server's CosNaming service by creating an object reference from the URL `corbaloc:iiop:1.2@<host>:<port>/<objectkey>` (where `<host>`, `<port>`, and `<objectkey>` are the values corresponding to the root `NamingContext` advertised by the server's CosNaming service), or by using an equivalent mechanism.

At deployment time, the Deployer of the client container should obtain the host, port and object key of the server's CosNaming service and the CosNaming name of the server EJBHome object (e.g. by browsing the server's namespace) for each such EJB annotation or `ejb-ref` element in the client component's deployment descriptor. The `ejb-ref-name` (which is used by the client code in the JNDI lookup call) should then be linked to the EJBHome object's CosNaming name. At run-time, the client component's JNDI lookup call uses the CosNaming service provider, which contacts the server's CosNaming service, resolves the CosNaming name, and returns the EJBHome object reference to the client component.

Since the EJBHome object's name is scoped within the namespace of the CosNaming service that is accessible at the provided host and port, it is not necessary to federate the namespaces of the client and server containers.

The advantage of using CosNaming is better integration with the IIOP infrastructure that is already required for interoperability, as well as interoperability with non-Java-EE CORBA clients and servers. Since CosNaming stores only CORBA objects it is likely that vendors will use other enterprise directory services for storing other resources.

Security of CosNaming service access is achieved using the security interoperability protocol described in Section 15.8. The CosNaming service must support this protocol. Clients which construct the root NamingContext object reference from a URL should send an IIOP `LocateRequest` message to the CosNaming service to obtain the complete IOR (with SSL information) of the root NamingContext, and then initiate an SSL session with the CosNaming service, as determined by the client policy.

15.8 Security Interoperability

This section describes the interoperable mechanisms that support secure invocations on enterprise beans in intranets. These mechanisms are based on the CORBA/IIOP protocol.

EJB containers are required to follow the protocol rules prescribed by the CSIV2 specification Conformance Level 0.

15.8.1 Introduction

The goal of the secure invocation mechanisms is to support the interoperability requirements described earlier in this chapter, as well as be capable of supporting security technologies that are expected to be widely deployed in enterprises, including Kerberos-based secret key mechanisms and X.509 certificate-based public key mechanisms.

The authentication identity (i.e. principal) associated with a Java EE component is usually that of the user on whose behalf the component is executing^[85]. The principal under which an enterprise bean invocation is performed is either that of the bean's caller or the run-as principal which was configured by the Deployer. When there is a chain of invocations across a web component and enterprise beans, an intermediate component may use the principal of the caller (the initiating client) or the intermediate component may use its run-as principal to perform an invocation on the callee, depending on the security identity specified for the intermediate component in its deployment descriptor.

The security principal associated with a container depends on the type of container. Application client containers usually do not have a separate principal associated with them (they operate under the user's principal). Web and EJB containers are typically associated with a security principal of their own (e.g., the operating system user for the container's process) which may be configured by the System Administrator at deployment time. When the client is a web or EJB container, the difference between the client component's principal and the client container's principal is significant for interoperability considerations.

15.8.1.1 Trust Relationships Between Containers, Principal Propagation

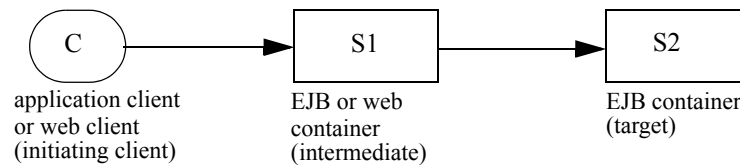

When there is a chain of multiple invocations across web components and enterprise beans, intermediate components may not have access to the authentication data of the initiating client to provide proof of the client's identity to the target. In such cases, the target's authentication requirements can be satisfied if the target container trusts the intermediate container to vouch for the authenticity of the propagated principal. The call is made using the intermediate container's principal and authentication data, while also carrying the propagated principal of the initiating client. The invocation on the target enterprise bean is authorized and performed using the propagated principal. This procedure also avoids the overhead associated with authentication of clients on every remote invocation in a chain.

EJB containers are required to provide the Deployer or Administrator with the tools to configure trust relationships for interactions with intermediate web or EJB containers^[86]. If a trust relationship is set up, the containers are usually configured to perform mutual authentication, unless the security of the network can be ensured by some physical means. If the network is physically secure, the target EJB container may be configured to trust all client containers. After a trust relationship is set up, the target EJB container does not need to independently authenticate the initiating client principal sent by the intermediate container on invocations. Thus only the principal name of the initiating client (which may include a realm) needs to be propagated. After a trust relationship has been established, the target EJB container must be able to accept invocations carrying only the principal name of the initiating client.

[85] When there are concurrent invocations on a component from multiple clients, a different principal may be associated with the thread of execution for each invocation.

[86] One way to achieve this is to configure a "trusted container list" for each EJB container which contains the list of intermediate client containers that are trusted. If the list is empty, then the target EJB container does not have a trust relationship with any intermediate container.

For the current interoperability needs of Java EE, it is assumed that trust relationships are transitive, such that if a target container trusts an intermediate container, it implicitly trusts all containers trusted by the intermediate container.

If no trust relationship has been set up between a target EJB container and an intermediate web or EJB container, the target container must not accept principals propagated from that intermediate container, hence the target container needs to have access to and independently verify the initiating client principal's authentication data.

Web and EJB containers are required to support caller propagation mode (where the initiating client's principal is propagated down the chain of calls on enterprise beans) and run-as mode (where the web/EJB component's run-as identity is propagated). This is needed for scenarios 1, 3 and 4 where the internet or intranet user's principal needs to be propagated to the target EJB container.

15.8.1.2 Application Client Authentication

Application client containers that have authentication infrastructure (such as certificates, Kerberos) can:

- authenticate the user by interacting with an authentication service (e.g. the Kerberos KDC) in the enterprise
- inherit an authentication context which was established at system login time from the operating system process, or
- obtain the user's certificate from a client-side store.

These may be achieved by plugging in a Java Authentication and Authorization Service (JAAS) login module for the particular authentication service. After authentication is completed, a credential is associated with the client's thread of execution, which is used for all invocations on enterprise beans made from that thread.

If there is no authentication infrastructure installed in the client's environment, or the authentication infrastructure is not capable of authenticating at the transport protocol layer, the client may send its private credentials (e.g. password) over a secure connection to the EJB server, which authenticates the user by interacting with an authentication service (e.g. a secure user/password database). This is similar to the basic authentication feature of HTTP.

15.8.2 Securing EJB Invocations

This subsection describes the interoperable protocol requirements for providing authentication, protection of integrity and confidentiality, and principal propagation for invocations on enterprise beans. The invocation takes place over an enterprise's intranet as described in the scenarios in section 15.3. Since EJB invocations use the IIOP protocol, we need to secure IIOP messages between client and server containers. The client container may be any of the Java EE containers; the server container is an EJB container.

The secure interoperability requirements for EJB 2.0 (and later) and other J2EE 1.3 (and later) containers are based on Conformance Level 0 of the Common Secure Interoperability version 2 (CSIV2) Final Available specification [23], which was developed by the OMG. EJB, web, and application client containers must support all requirements of Conformance Level 0 of the CSIV2 specification. The following subsections describe how the CSIV2 features are used to realize the scenarios described in section 15.3.

15.8.2.1 Secure Transport Protocol

The Secure Sockets Layer (SSL 3.0) protocol [22] and the related IETF standard Transport Layer Security (TLS 1.0) protocol [20] provide authentication and message protection (that is, integrity and/or confidentiality) at the transport layer. The original SSL and TLS specifications supported only X.509 certificates for authenticating principals. Recently, Kerberos-based authentication mechanisms and cipher suites have been defined for TLS (RFC 2712 [21]). Thus the TLS specification is capable of supporting the two main security technologies that are expected to be widely deployed in enterprises.

EJB, web and application client containers are required to support both SSL 3.0 and TLS 1.0 as security protocols for IIOP. This satisfies interoperability requirement 3 in section 15.4. Compliant containers must be capable of using the following public key SSL/TLS ciphersuites based on policies set by the System Administrator:

- TLS_RSA_WITH_RC4_128_MD5
- SSL_RSA_WITH_RC4_128_MD5
- TLS_DHE_DSS_WITH_3DES_EDE_CBC_SHA^[87]
- SSL_DHE_DSS_WITH_3DES_EDE_CBC_SHA
- TLS_RSA_EXPORT_WITH_RC4_40_MD5
- SSL_RSA_EXPORT_WITH_RC4_40_MD5
- TLS_DHE_DSS_EXPORT_WITH_DES40_CBC_SHA
- SSL_DHE_DSS_EXPORT_WITH_DES40_CBC_SHA

Support for Kerberos ciphersuites is not specified.

When using IIOP over SSL, a secure channel between client and server containers is established at the SSL layer. The SSL handshake layer handles authentication (either mutual or server-only) between containers, negotiation of cipher suite for bulk data encryption, and optionally provides a compression method. The SSL record layer performs confidentiality and integrity protection on application data. Since compliant Java EE products are already required to support SSL (HTTPS for Internet communication), the use of SSL/TLS provides a relatively easy route to interoperable security at the transport layer.

[87] This ciphersuite is mandatory for compliant TLS implementations as specified in [20].

15.8.2.2 Security Information in IORs

Before initiating a secure connection to the EJB container, the client needs to know the hostname and port number at which the server is listening for SSL connections, and the security protocols supported or required by the server object. This information is obtained from the EJBObject or EJBHome reference's IOR.

The CSiv2 specification [23] describes the `TAG_CSI_SEC_MECH_LIST` tagged component which is included in the IORs of secured objects. This component contains a sequence of `CSIIOP::CompoundSecMech` structures (in decreasing order of the server's preference) that contain the target object's security information for transport layer and service context layer mechanisms. This information includes the server's SSL/TLS port, its security principal and supported/required security mechanisms.

EJB containers must be capable of inserting the CSiv2 tagged components into the IORs for EJBObject and EJBHome references, based on the Deployer or System Administrator's security policy settings. Compliant EJB containers must follow the Conformance Level 0 rules described in the CSiv2 specification for constructing these IORs.

EJB containers must also be capable of creating IORs that allow access to enterprise beans over unprotected IIOP, based on the security policies set by the Deployer or System Administrator.

15.8.2.3 Propagating Principals and Authentication Data in IIOP Messages

In scenarios where client authentication does not occur at the transport layer it is necessary to support transfer of authentication data between two containers in the IIOP message service context. When an intermediate client container does not have authentication data for the initiating client, it is necessary to support propagation of client principals in the IIOP message service context.

It is assumed that all information exchanged between client and server at the transport layer is also available to the containers: e.g. the certificates used for authentication at the SSL layer may be used by the server container for authorization.

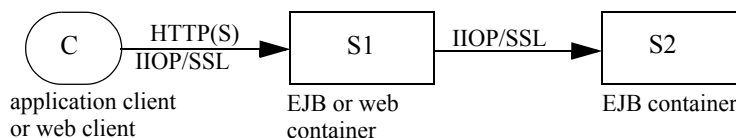

The following cases are required to be supported:

1. Application client invocations on enterprise beans with mutual authentication between the application client and EJB container (C and S1) at the SSL layer (scenario 2.1 in section 15.3.2, interoperability requirement 4.1 in section 15.4). For example, this is possible when the enterprise has a Kerberos-based authentication infrastructure or when client-side certificates have been installed. In this case the security context of the IIOP message sent from C to S1 should not contain any additional information.

2. Application client invocations on enterprise beans with server-only authentication between the application client and EJB container (C and S1) at the SSL layer (scenario 2.2 in section 15.3.2, interoperability requirement 4.2 in section 15.4). This usually happens when the client cannot authenticate in the transport. In this case, the client container must be capable of inserting into the IIOP message a CSIV2 security context with a client authentication token that contains the client C's authentication data. Once the EJB container S1 has authenticated the client, it may or may not maintain state about the client, so subsequent invocations from the client on the same network connection may need to be authenticated again. The client and server containers must follow the Conformance Level 0 rules in the CSIV2 specification for client authentication. In particular, support for the GSSUP username-password authentication mechanism is required. Support for other GSSAPI mechanisms (such as Kerberos) to perform client authentication at the IIOP layer is optional.
3. Invocations from Web/EJB clients to enterprise beans with a trust relationship between the client container S1 and server container S2 (scenarios 1,3 and 4 in section 15.3.3, interoperability requirements five and six in section 15.4). S2 does not need to independently authenticate the initiating client C. In this case the client container S1 must insert into the IIOP message a security context with an identity token in the format described in the CSIV2 specification. The principal may be propagated as an X.509 certificate chain or as a X.501 distinguished name or as a principal name encoded in the GSS exported name format, as described in the CSIV2 specification. The identity propagated is determined as follows:
 - If the client Web/EJB component is configured to use caller identity, and the caller C authenticated itself to S1, then the identity token contains the initiating client C's identity.
 - If the client component is configured to use caller identity, and the caller C did not authenticate itself to S1, then the identity token contains the anonymous type.
 - If the client component is configured to use a run-as identity then the identity token contains the run-as identity.

Java EE containers are required to support the stateless mode of propagating principal and authentication information defined in CSIV2 (where the server does not store any state for a particular client principal across invocations), and may optionally support the stateful mode.

The caller principal String provided by `EJBContext.getCallerPrincipal().getName()` is defined as follows:

- For case one, the principal should be derived from the distinguished name obtained from the first X.509 certificate in the client's certificate chain that was provided to the server during SSL mutual authentication.
- For case two, the principal should be derived from the username obtained from the client authentication token in the CSIV2 security context of the IIOP message. For the GSSUP username-password mechanism, the principal should be derived from the username in the `GSSUP::InitialContextToken` structure.
- For case three, the principal depends on the identity token type in the CSIV2 security context:
 - If the type is X.509 certificate chain, then the principal should be derived from the distinguished name from the first certificate in the chain.

- If the type is distinguished name, then the principal should be derived from the distinguished name.
- If the type is principal name propagated as a GSS exported name, then the principal should be derived from the mechanism-specific principal name.
- If the anonymous principal type was propagated or the identity token was absent, then `EJBContext.getCallerPrincipal().getName()` returns a product-specific unauthenticated principal name.

15.8.2.4 Security Configuration for Containers

Since the interoperability scenarios involve IIOP/SSL usage in intranets, it is assumed that client and server container administrators cooperatively configure a consistent set of security policies for the enterprise.

At product installation or application deployment time, client and server container administrators may optionally configure the container and SSL infrastructure as described below. These preferences may be specified at any level of granularity (e.g. per host or per container process or per enterprise bean).

- Configure the list of supported SSL cipher suites in preference order.
- For server containers, configure a list of trusted client container principals with whom the server has a trust relationship.
- Configure authentication preferences and requirements (e.g. if the server prefers authenticated clients to anonymous clients). In particular, if a trust relationship has been configured between two servers, then mutual authentication should be required unless there is physical network security.
- If the client and server are using certificates for authentication, configure a trusted common certificate authority for both client and server. If using Kerberos, configure the client and server with the same KDC or cooperating KDCs.
- Configure a restricted list of trusted server principals that a client container is allowed to interact with, to prevent the client's private credentials such as password from being sent to untrusted servers.

15.8.2.5 Runtime Behavior

Client containers determine whether to use SSL for an enterprise bean invocation by using the security policies configured by the client administrator for interactions with the target host or enterprise bean, and the `target_requires` information in the CSIv2 tagged component in the target enterprise bean's IOR. If either the client configuration requires secure interactions with the enterprise bean, or the enterprise bean requires a secure transport, the client should initiate an SSL connection to the server. The client must follow the rules described in the CSIv2 specification Conformance Level 0 for interpreting security information in IORs and including security context information in IIOP messages.

When an EJB container receives an IIOP message, its behavior depends on deployment time configuration, run-time information exchanged with the client at the SSL layer, and principal/authentication data contained in the IIOP message service context. EJB containers are required to follow the protocol rules prescribed by the CSIV2 specification Conformance Level 0.

When the System Administrator changes the security policies associated with an enterprise bean, the IORs for EJB references should be updated. When the bean has existing clients holding IORs, it is recommended that the security policy change should be handled by the client and server containers transparently to the client application if the old security policy is compatible with the new one. This may be done by using interoperable GIOP 1.2 forwarding mechanisms.

Enterprise Bean Environment

This chapter specifies how enterprise beans declare dependencies on external resources and other objects in their environment, and how those items can be injected into enterprise beans or accessed in the JNDI naming context.

16.1 Overview

The Application Assembler and Deployer should be able to customize an enterprise bean's business logic without accessing the enterprise bean's source code.

In addition, ISVs typically develop enterprise beans that are, to a large degree, independent from the operational environment in which the application will be deployed. Most enterprise beans must access resource managers and external information. The key issue is how enterprise beans can locate external information without prior knowledge of how the external information is named and organized in the target operational environment. The JNDI naming context and Java language metadata annotations provide this capability.

The enterprise bean environment mechanism attempts to address both of the above issues.

This chapter is organized as follows.

- Section 16.2 defines the general rules for the use of the JNDI naming context and its interaction with Java language annotations that reference entries in the naming context.
- Section 16.3 defines the general responsibilities for each of the EJB roles, such as Bean Provider, Application Assembler, Deployer, and Container Provider.
- Section 16.4 defines the basic mechanisms and interfaces that specify and access the enterprise bean's environment. The section illustrates the use of the enterprise bean's environment for generic customization of the enterprise bean's business logic.
- Section 16.5 defines the means for obtaining the business interface or home interface of another enterprise bean using an *EJB reference*. An EJB reference is a special entry in the enterprise bean's environment.
- Section 16.6 defines the means for obtaining the web service interface using a *web service reference*. A web service reference is a special entry in the enterprise bean's environment.
- Section 16.7 defines the means for obtaining a resource manager connection factory using a *resource manager connection factory reference*. A resource manager connection factory reference is a special entry in the enterprise bean's environment.
- Section 16.8 defines the means for obtaining an administered object that is associated with a resource (e.g., a CCI *InteractionSpec*) using a *resource environment reference*. A resource environment reference is a special entry in the enterprise bean's environment.
- Section 16.9 defines the means for obtaining a message destination associated with a resource using a *message destination reference*. Message destination references allow the flow of messages within an application to be specified. A message destination reference is a special entry in the enterprise bean's environment.
- Section 16.10 describes the means for obtaining an entity manager factory using a *persistence unit reference*.
- Section 16.11 describes the means for obtaining an entity manager using a *persistence context reference*.
- Section 16.12 describes the use by eligible enterprise beans of references to a *UserTransaction* object in the bean's environment to start, commit, and rollback transactions.
- Section 16.13 describes the use of references to a CORBA *ORB* object in the enterprise bean's environment.
- Section 16.14 describes the means for obtaining the *TimerService*.
- Section 16.15 describes the means for obtaining a bean's *EJBContext* object.

16.2 Enterprise Bean's Environment as a JNDI Naming Context

The enterprise bean's environment is a mechanism that allows customization of the enterprise bean's business logic during deployment or assembly. The enterprise bean's environment allows the enterprise bean to be customized without the need to access or change the enterprise bean's source code.

Annotations and deployment descriptors are the main vehicles for conveying access information to the application assembler and deployer about beans' requirements for customization of business logic and access to external information.

The container implements the enterprise bean's environment, and provides it as a JNDI naming context. The enterprise bean's environment is used as follows:

1. The enterprise bean makes use of entries from the environment. Entries from the environment may be injected by the container into the bean's fields or methods, or the methods of the bean may access the environment using the `EJBContext lookup` method or the JNDI interfaces. The Bean Provider declares in Java language metadata annotations or in the deployment descriptor all the environment entries that the enterprise bean expects to be provided in its environment at runtime.
2. The container provides an implementation of the JNDI naming context that stores the enterprise bean environment. The container also provides the tools that allow the Deployer to create and manage the environment of each enterprise bean.
3. The Deployer uses the tools provided by the container to create and initialize the environment entries that are declared by means of the enterprise bean's annotations or deployment descriptor. The Deployer can set and modify the values of the environment entries.
4. The container injects entries from the environment into the enterprise bean's fields or methods as specified by the bean's metadata annotations or the deployment descriptor.
5. The container makes the environment naming context available to the enterprise bean instances at runtime. The enterprise bean's instances can use the `EJBContext lookup` method or the JNDI interfaces to obtain the values of the environment entries.

The container must make an enterprise bean's environment available to any interceptor class and any JAX-WS message handler for the bean as well. The interceptor and web service handler classes for an enterprise bean share that bean's environment. Within the context of this chapter, the term "bean" should be construed as including a bean's interceptor and handler classes unless otherwise noted.

16.2.1 Sharing of Environment Entries

For enterprise beans packaged in an `ejb-jar`, each enterprise bean defines its own set of environment entries. In this case, all instances of an enterprise bean share the same environment entries; the environment entries are not shared with other enterprise beans.

In a `.war`, there is only a single naming environment shared between all the components in the module. For enterprise beans packaged in a `.war`, all enterprise beans share this single naming environment. The enterprise beans share their environment entries with all other enterprise bean components and web components in the `.war`.

Enterprise bean instances are not allowed to modify the bean's environment at runtime.

Compatibility Note: If an enterprise bean written to the EJB 2.1 API specification is deployed multiple times in the same container, each deployment results in the creation of a distinct home. The Deployer may set different values for the enterprise bean environment entries for each home.

In general, lookups of objects in the JNDI `java: namespace` are required to return a new instance of the requested object every time. Exceptions are allowed for the following:

- The container knows the object is immutable (for example, objects of type `java.lang.String`), or knows that the application can't change the state of the object.
- The object is defined to be a singleton, such that only one instance of the object may exist in the JVM.
- The name used for the lookup is defined to return an instance of the object that might be shared. The name `java:comp/ORB` is such a name.

In these cases, a shared instance of the object may be returned. In all other cases, a new instance of the requested object must be returned on each lookup. Note that, in the case of resource adapter connection objects, it is the resource adapter's `ManagedConnectionFactory` implementation that is responsible for satisfying this requirement.

Each injection of an object corresponds to a JNDI lookup. Whether a new instance of the requested object is injected, or whether a shared instance is injected, is determined by the rules described above.

Terminology warning: The enterprise bean's "environment" should not be confused with the "environment properties" defined in the JNDI documentation.

16.2.2 Annotations for Environment Entries

A field or method of a bean class may be annotated to request that an entry from the bean's environment be injected. Any of the types of resources or other environment entries^[88] described in this chapter may be injected. Injection may also be requested using entries in the deployment descriptor corresponding to each of these resource types. The field or method may have any access qualifier (`public`, `private`, etc.) but must not be `static`.

- A field of the bean class may be the target of injection. The field must not be `final`. By default, the name of the field is combined with the name of the class in which the annotation is used and is used directly as the name in the bean's naming context. For example, a field named `myDatabase` in the class `MySessionBean` in the package `com.acme.example` would

[88] The term "resource" is used generically in this chapter to refer to these other environment entries as resources as well. Resources in the non-generic sense are described in section 16.7.

correspond to the JNDI name `java:comp/env/com.acme.example.MySessionBean/myDatabase`. The annotation also allows the JNDI name to be specified explicitly.

- Environment entries may also be injected into the bean through bean methods that follow the naming conventions for JavaBeans properties. The annotation is applied to the `set` method for the property, which is the method that is called to inject the environment entry. The JavaBeans property name (not the method name) is used as the default JNDI name. For example, a method named `setMyDatabase` in the same `MySessionBean` class would correspond to the JNDI name `java:comp/env/com.example.MySessionBean/myDatabase`.
- When a deployment descriptor entry is used to specify injection, the JNDI name and the instance variable name or property name are both specified explicitly. Note that the JNDI name is always relative to the `java:comp/env` naming context.

Each resource may only be injected into a single field or method of the bean. Requesting injection of the `java:comp/env/com.example.MySessionBean/myDatabase` resource into both the `setMyDatabase` method and the `myDatabase` instance variable is an error. Note, however, that either the field or the method could request injection of a resource of a different (non-default) name. By explicitly specifying the JNDI name of a resource, a single resource may be injected into multiple fields or methods of multiple classes.

Annotations may also be applied to the bean class itself. These annotations declare an entry in the bean's environment, but do not cause the resource to be injected. Instead, the bean is expected to use the `EJBContext lookup` method or the methods of the JNDI API to lookup the entry. When the annotation is applied to the bean class, the JNDI name and the environment entry type must be explicitly specified.

Annotations may appear on the bean class, or on any superclass. A resource annotation on any class in the inheritance hierarchy defines a resource needed by the bean. However, injection of such resources follows the Java language overriding rules for the visibility of fields and methods. A method definition that overrides a method on a superclass defines the resource, if any, to be injected into that method. An overriding method may request injection of a different resource than is requested by the superclass, or it may request no injection even though the superclass method requests injection.

In addition, fields or methods that are not visible in or are hidden (as opposed to overridden) by a subclass may still request injection. This allows, for example, a private field to be the target of injection and that field to be used in the implementation of the superclass, even though the subclass has no visibility into that field and doesn't know that the implementation of the superclass is using an injected resource. Note that a declaration of a field in a subclass with the same name as a field in a superclass always causes the field in the superclass to be hidden.

16.2.3 Annotations and Deployment Descriptors

Environment entries may be declared by the use of annotations, without need for any deployment descriptor entries. Environment entries may also be declared by deployment descriptor entries, without need for any annotations. The same environment entry may be declared using both an annotation and a deployment descriptor entry. In this case, the information in the deployment descriptor entry may be used to override some of the information provided in the annotation. This approach may be used by an Application Assembler to override information provided by the Bean Provider. Deployment descriptor entries should not be used to request injection of a resource into a field or method that has not been designed for injection.

The following rules apply to how a deployment descriptor entry may override a `Resource` annotation:

- The relevant deployment descriptor entry is located based on the JNDI name used with the annotation (either defaulted or provided explicitly).
- The type specified in the deployment descriptor must be assignable to the type of the field or property or the type specified in the `Resource` annotation.
- The description, if specified, overrides the description element of the annotation.
- The injection target, if specified, must name exactly the annotated field or property method.
- The `res-sharing-scope` element, if specified, overrides the `shareable` element of the annotation. In general, the Application Assembler or Deployer should never change the value of this element, as doing so is likely to break the application.
- The `res-auth` element, if specified, overrides the `authenticationType` element of the annotation. In general, the Application Assembler or Deployer should never change the value of this element, as doing so is likely to break the application.

Restrictions on the overriding of environment entry values depend on the type of environment entry.

The rules for how a deployment descriptor entry may override an EJB annotation are described in Section 16.5. The rules for how a deployment descriptor entry may override a `PersistenceUnit` or `PersistenceContext` annotation are described in Sections 16.10 and 16.11. The rules for web services references and how a deployment descriptor entry may override a `WebServiceRef` annotation are included in the Web Services for Java EE specification [31].

16.3 Responsibilities by EJB Role

This section describes the responsibilities of the various EJB roles with regard to the specification and handling of environment entries. The sections that follow describe the responsibilities that are specific to the different types of objects that may be stored in the naming context.

16.3.1 Bean Provider's Responsibilities

The Bean Provider may use Java language annotations or deployment descriptor entries to request injection of a resource from the naming context, or to declare entries that are needed in the naming context. The Bean Provider may also use the `EJBContext lookup` method or the JNDI APIs to access entries in the naming context. Deployment descriptor entries may also be used by the Bean Provider to override information provided by annotations.

When using JNDI interfaces directly, an enterprise bean instance creates a `javax.naming.InitialContext` object by using the constructor with no arguments, and looks up the environment naming via the `InitialContext` under the name `java:comp/env`.

The enterprise bean's environment entries are stored directly in the environment naming context, or in any of its direct or indirect subcontexts.

The value of an environment entry is of the Java type declared by the Bean Provider in the metadata annotation or deployment descriptor, or the type of the instance variable or setter method parameter of the method with which the metadata annotation is associated.

16.3.2 Application Assembler's Responsibility

The Application Assembler is allowed to modify the values of the environment entries set by the Bean Provider, and is allowed to set the values of those environment entries for which the Bean Provider has not specified any initial values. The Application Assembler uses the deployment descriptor to override settings made by the Bean Provider, whether these were defined by the Bean Provider in the deployment descriptor or in the source code using annotations.

16.3.3 Deployer's Responsibility

The Deployer must ensure that the values of all the environment entries declared by an enterprise bean are created and/or set to meaningful values.

The Deployer can modify the values of the environment entries that have been previously set by the Bean Provider and/or Application Assembler, and must set the values of those environment entries for which no value has been specified.

The `description` elements provided by the Bean Provider or Application Assembler help the Deployer with this task.

16.3.4 Container Provider Responsibility

The Container Provider has the following responsibilities:

- Provide a deployment tool that allows the Deployer to set and modify the values of the enterprise bean's environment entries.
- Implement the `java:comp/env` environment naming context, and provide it to the enterprise bean instances at runtime. The naming context must include all the environment entries declared by the Bean Provider, with their values supplied in the deployment descriptor or set

by the Deployer. The environment naming context must allow the Deployer to create subcontexts if they are needed by an enterprise bean.

- Inject entries from the naming environment, as specified by annotations or by the deployment descriptor.
- The container must ensure that the enterprise bean instances have only read access to their environment variables. The container must throw the `javax.naming.OperationNotSupportedException` from all the methods of the `javax.naming.Context` interface that modify the environment naming context and its subcontexts.

16.4 Simple Environment Entries

A simple environment entry is a configuration parameter used to customize an enterprise bean's business logic. The environment entry values may be one of the following Java types: `String`, `Character`, `Integer`, `Boolean`, `Double`, `Byte`, `Short`, `Long`, and `Float`.

The following subsections describe the responsibilities of each EJB role.

16.4.1 Bean Provider's Responsibilities

This section describes the Bean Provider's view of the bean's environment, and defines his or her responsibilities. The first subsection describes annotations for injecting simple environment entries; the second describes the API for accessing simple environment entries; and the third describes syntax for declaring the environment entries in a deployment descriptor.

16.4.1.1 Injection of Simple Environment Entries Using Annotations

The Bean Provider uses the `Resource` annotation to annotate a field or method of the bean class as a target for the injection of a simple environment entry. The name of the environment entry is as described in Section 16.2.2; the type is as described in Section 16.4. Note that the container will unbox the environment entry as required to match it to a primitive type used for the injection field or method. The `authenticationType` and `shareable` elements of the `Resource` annotation must not be specified; simple environment entries are not shareable and do not require authentication.

The following code example illustrates how an enterprise bean uses annotations for the injection of environment entries.

```
@Stateless public class EmployeeServiceBean
    implements EmployeeService {

    ...
    // The maximum number of tax exemptions, configured by Deployer
    @Resource int maxExemptions;

    // The minimum number of tax exemptions, configured by Deployer
    @Resource int minExemptions;

    public void setTaxInfo(int numberOfExemptions,...)
        throws InvalidNumberOfExemptionsException {
        ...
        // Use the environment entries to customize business logic.
        if (numberOfExemptions > maxExemptions ||
            numberOfExemptions < minExemptions)
            throw new InvalidNumberOfExemptionsException();
    }
}
```

16.4.1.2 Programming Interfaces for Accessing Simple Environment Entries

In addition to the use of injection as described above, an enterprise bean may access environment entries dynamically. This may be done by means of the `EJBContext lookup` method or by direct use of the JNDI interfaces. The environment entries are declared by the Bean Provider by means of annotations on the bean class or in the deployment descriptor.

When the JNDI interfaces are used directly, the bean instance creates a `javax.naming.InitialContext` object by using the constructor with no arguments, and looks up the naming environment via the `InitialContext` under the name `java:comp/env`. The bean's environmental entries are stored directly in the environment naming context, or its direct or indirect subcontexts.

The following code example illustrates how an enterprise bean accesses its environment entries when the JNDI APIs are used directly. In this example, the names under which the entries are accessed are defined by the deployment descriptor, as shown in the example of section 16.4.1.3.

```
@Stateless public class EmployeeServiceBean
    implements EmployeeService {
    ...
    public void setTaxInfo(int numberOfExemptions, ...)
        throws InvalidNumberOfExemptionsException {
        ...

        // Obtain the enterprise bean's environment naming context.
        Context initCtx = new InitialContext();
        Context myEnv = (Context)initCtx.lookup("java:comp/env");

        // Obtain the maximum number of tax exemptions
        // configured by the Deployer.
        Integer maxExemptions =
            (Integer)myEnv.lookup("maxExemptions");

        // Obtain the minimum number of tax exemptions
        // configured by the Deployer.
        Integer minExemptions =
            (Integer)myEnv.lookup("minExemptions");

        // Use the environment entries to customize business logic.
        if (numberOfExemptions > maxExemptions ||
            numberOfExemptions < minExemptions)
            throw new InvalidNumberOfExemptionsException();

        // Get some more environment entries. These environment
        // entries are stored in subcontexts.
        String val1 = (String)myEnv.lookup("foo/name1");
        Boolean val2 = (Boolean)myEnv.lookup("foo/bar/name2");

        // The enterprise bean can also lookup using full pathnames.
        Integer val3 = (Integer)
            initCtx.lookup("java:comp/env/name3");
        Integer val4 = (Integer)
            initCtx.lookup("java:comp/env/foo/name4");
        ...
    }
}
```

16.4.1.3 Declaration of Simple Environment Entries in the Deployment Descriptor

The Bean Provider must declare all the simple environment entries accessed from the enterprise bean's code. The simple environment entries are declared either using annotations in the bean class code or using the `env-entry` elements in the deployment descriptor.

Each `env-entry` deployment descriptor element describes a single environment entry. The `env-entry` element consists of an optional description of the environment entry, the environment entry name relative to the `java:comp/env` context, the expected Java type of the environment entry value (i.e., the type of the object returned from the `EJBContext` or `JNDI` lookup method), and an optional environment entry value.

See Section 16.2.1 for environment entry name scoping rules.

If the Bean Provider provides a value for an environment entry using the `env-entry-value` element, the value can be changed later by the Application Assembler or Deployer. The value must be a string that is valid for the constructor of the specified type that takes a single `String` parameter, or for `java.lang.Character`, a single character.

The following example is the declaration of environment entries used by the `EmployeeServiceBean` whose code was illustrated in the previous subsection.

```

<enterprise-beans>
  <session>
    ...
    <ejb-name>EmployeeService</ejb-name>
    <ejb-class>com.wombat.empl.EmployeeServiceBean</ejb-class>
    ...
    <env-entry>
      <description>
        The maximum number of tax exemptions
        allowed to be set.
      </description>
      <env-entry-name>maxExemptions</env-entry-name>
      <env-entry-type>java.lang.Integer</env-entry-type>
      <env-entry-value>15</env-entry-value>
    </env-entry>
    <env-entry>
      <description>
        The minimum number of tax exemptions
        allowed to be set.
      </description>
      <env-entry-name>minExemptions</env-entry-name>
      <env-entry-type>java.lang.Integer</env-entry-type>
      <env-entry-value>1</env-entry-value>
    </env-entry>
    <env-entry>
      <env-entry-name>foo/name1</env-entry-name>
      <env-entry-type>java.lang.String</env-entry-type>
      <env-entry-value>value1</env-entry-value>
    </env-entry>
    <env-entry>
      <env-entry-name>foo/bar/name2</env-entry-name>
      <env-entry-type>java.lang.Boolean</env-entry-type>
      <env-entry-value>true</env-entry-value>
    </env-entry>
    <env-entry>
      <description>Some description.</description>
      <env-entry-name>name3</env-entry-name>
      <env-entry-type>java.lang.Integer</env-entry-type>
    </env-entry>
    <env-entry>
      <env-entry-name>foo/name4</env-entry-name>
      <env-entry-type>java.lang.Integer</env-entry-type>
      <env-entry-value>10</env-entry-value>
    </env-entry>
    ...
  </session>
</enterprise-beans>
...

```

Injection of environment entries may also be specified using the deployment descriptor, without need for Java language annotations. The following is an example of the declaration of environment entries corresponding to the example of section 16.4.1.1.

```
<enterprise-beans>
  <session>
    ...
    <ejb-name>EmployeeService</ejb-name>
    <ejb-class>com.wombat.empl.EmployeeServiceBean</ejb-class>
    ...
    <env-entry>
      <description>
        The maximum number of tax exemptions
        allowed to be set.
      </description>
      <env-entry-name>
        com.wombat.empl.EmployeeService/maxExemptions
      </env-entry-name>
      <env-entry-type>java.lang.Integer</env-entry-type>
      <env-entry-value>15</env-entry-value>
      <injection-target>
        <injection-target-class>
          com.wombat.empl.EmployeeServiceBean
        </injection-target-class>
        <injection-target-name>
          maxExemptions
        </injection-target-name>
      </injection-target>
    </env-entry>
    <env-entry>
      <description>
        The minimum number of tax exemptions
        allowed to be set.
      </description>
      <env-entry-name>
        com.wombat.empl.EmployeeService/minExemptions
      </env-entry-name>
      <env-entry-type>java.lang.Integer</env-entry-type>
      <env-entry-value>1</env-entry-value>
      <injection-target>
        <injection-target-class>
          com.wombat.empl.EmployeeServiceBean
        </injection-target-class>
        <injection-target-name>
          minExemptions
        </injection-target-name>
      </injection-target>
    </env-entry>
    ...
  </session>
</enterprise-beans>
...
```

It is often convenient to declare a field as an injection target, but to specify a default value in the code, as illustrated in the following example.

```
// The maximum number of tax exemptions, configured by the Deployer.
@Resource int maxExemptions = 4; // defaults to 4
```

To support this case, the container must only inject a value for the environment entry if the application assembler or deployer has specified a value to override the default value. The `env-entry-value` element in the deployment descriptor is optional when an injection target is specified. If the element is not specified, no value will be injected. In addition, if the element is not specified, the named resource is not initialized in the naming context, and explicit lookups of the named resource will fail.

16.4.2 Application Assembler's Responsibility

The Application Assembler is allowed to modify the values of the simple environment entries set by the Bean Provider, and is allowed to set the values of those environment entries for which the Bean Provider has not specified any initial values. The Application Assembler may use the deployment descriptor to override settings made by the Bean Provider, whether in the deployment descriptor or using annotations.

16.4.3 Deployer's Responsibility

The Deployer must ensure that the values of all the simple environment entries declared by an enterprise bean are set to meaningful values.

The Deployer can modify the values of the environment entries that have been previously set by the Bean Provider and/or Application Assembler, and must set the values of those environment entries for which no value has been specified.

The `description` elements provided by the Bean Provider or Application Assembler help the Deployer with this task.

16.4.4 Container Provider Responsibility

The Container Provider has the following responsibilities:

- Provide a deployment tool that allows the Deployer to set and modify the values of the enterprise bean's environment entries.
- Implement the `java:comp/env` environment naming context, and provide it to the enterprise bean instances at runtime. The naming context must include all the environment entries declared by the Bean Provider, with their values supplied in the deployment descriptor or set by the Deployer. The environment naming context must allow the Deployer to create subcontexts if they are needed by an enterprise bean.
- Inject entries from the naming environment into the bean instance, as specified by the annotations on the bean class or by the deployment descriptor.
- The container must ensure that the enterprise bean instances have only read access to their environment variables. The container must throw the `javax.naming.OperationNotSupportedException` from all the methods of the `javax.naming.Context` interface that modify the environment naming context and its subcontexts.

16.5 EJB References

This section describes the programming and deployment descriptor interfaces that allow the Bean Provider to refer to the business interfaces or no-interface views or homes of other enterprise beans using “logical” names called *EJB references*. The EJB references are special entries in the enterprise bean’s environment. The Deployer binds the EJB references to the enterprise bean business interfaces or no-interface views or homes in the target operational environment, as appropriate.

The deployment descriptor also allows the Application Assembler to link an EJB reference declared in one enterprise bean to another enterprise bean contained in the same `ejb-jar` file, or in another `ejb-jar` file in the same Java EE application unit. The link is an instruction to the tools used by the Deployer that the EJB reference should be bound to the business interface or no-interface view or home of the specified target enterprise bean. This linking can also be specified by the Bean Provider using annotations in the source code of the bean class.

16.5.1 Bean Provider’s Responsibilities

This section describes the Bean Provider’s view and responsibilities with respect to EJB references. The first subsection describes annotations for injecting EJB references; the second describes the API for accessing EJB references; and the third describes syntax for declaring the EJB references in a deployment descriptor.

16.5.1.1 Injection of EJB References

The Bean Provider uses the `EJB` annotation to annotate a field or setter property method of the bean class as a target for the injection of an EJB reference. The reference may be to a session bean’s business interface or to a session bean’s no-interface view or to the local home interface or remote home interface of a session bean or entity bean.

The following example illustrates how an enterprise bean uses the `EJB` annotation to reference another enterprise bean. The enterprise bean reference will have the name `java:comp/env/com.acme.example.ExampleBean/myCart` in the referencing bean’s naming context, where `ExampleBean` is the name of the class of the referencing bean and `com.acme.example` its package. The target of the reference must be resolved by the Deployer, unless there is only one session bean component within the same application that exposes a client view type which matches the EJB reference.

```
package com.acme.example;

@Stateless public class ExampleBean implements Example {
    ...
    @EJB private ShoppingCart myCart;
    ...
}
```

The following example illustrates use of almost all portable elements of the EJB annotation. In this case, the enterprise bean reference would have the name `java:comp/env/ejb/shopping-cart` in the referencing bean's naming context. This reference is linked to a bean named `cart1`.

```
@EJB(
    name="ejb/shopping-cart",
    beanInterface=ShoppingCart.class,
    beanName="cart1",
    description="The shopping cart for this application"
)
private ShoppingCart myCart;
```

As an alternative to `beanName`, a reference to an EJB can use a session bean JNDI name, by means of the `lookup` annotation element. The following example uses a JNDI name in the application namespace.

```
@EJB(
    lookup="java:app/cartModule/ShoppingCart",
    description="The shopping cart for this application"
)
private ShoppingCart myOtherCart;
```

If the `ShoppingCart` bean were instead written to the EJB 2.1 client view, the EJB reference would be to the bean's home interface. For example:

```
@EJB(
    name="ejb/shopping-cart",
    beanInterface=ShoppingCartHome.class,
    beanName="cart1",
    description="The shopping cart for this application"
)
private ShoppingCartHome myCartHome;
```

If the `ShoppingCart` bean were instead written to the no-interface client view and was implemented by bean class `ShoppingCartBean.class`, the EJB reference would have type `ShoppingCartBean.class`. For example:

```
@EJB(
    name="ejb/shopping-cart",
    beanInterface=ShoppingCartBean.class,
    beanName="cart1",
    description="The shopping cart for this application"
)
private ShoppingCartBean myCart;
```

16.5.1.2 EJB Reference Programming Interfaces

The Bean Provider may use EJB references to locate the business interfaces or no-interface views or home interfaces of other enterprise beans as follows.

- Assign an entry in the enterprise bean's environment to the reference. (See subsection 16.5.1.3 for information on how EJB references are declared in the deployment descriptor.)

- The EJB specification recommends, but does not require, that all references to other enterprise beans be organized in the `ejb` subcontext of the bean's environment (i.e., in the `java:comp/env/ejb` JNDI context). Note that enterprise bean references declared by means of annotations will not, by default, be in any subcontext.
- Look up the business interface or no-interface view or home interface of the referenced enterprise bean in the enterprise bean's environment using the `EJBContext lookup` method or the JNDI API.

The following example illustrates how an enterprise bean uses an EJB reference to locate the remote home interface of another enterprise bean using the JNDI APIs.

```
@EJB(name="ejb/EmplRecord", beanInterface=EmployeeRecordHome.class)
@Stateless public class EmployeeServiceBean
    implements EmployeeService {

    public void changePhoneNumber(...) {
        ...

        // Obtain the default initial JNDI context.
        Context initCtx = new InitialContext();

        // Look up the home interface of the EmployeeRecord
        // enterprise bean in the environment.
        Object result = initCtx.lookup(
            "java:comp/env/ejb/EmplRecord");

        // Convert the result to the proper type.
        EmployeeRecordHome emplRecordHome = (EmployeeRecordHome)
            javax.rmi.PortableRemoteObject.narrow(result,
                EmployeeRecordHome.class);

        ...
    }
}
```

In the example, the Bean Provider of the `EmployeeServiceBean` enterprise bean assigned the environment entry `ejb/EmplRecord` as the EJB reference name to refer to the remote home of another enterprise bean.

16.5.1.3 Declaration of EJB References in Deployment Descriptor

Although the EJB reference is an entry in the enterprise bean's environment, the Bean Provider must not use a `env-entry` element to declare it. Instead, the Bean Provider must declare all the EJB references using the `ejb-ref` and `ejb-local-ref` elements of the deployment descriptor. This allows the `ejb-jar` consumer (i.e. Application Assembler or Deployer) to discover all the EJB references used by the enterprise bean. Deployment descriptor entries may also be used to specify injection of an EJB reference into a bean.

Each `ejb-ref` or `ejb-local-ref` element describes the interface requirements that the referencing enterprise bean has for the referenced enterprise bean. The `ejb-ref` element is used for referencing an enterprise bean that is accessed through its remote business interface or remote home and component interfaces. The `ejb-local-ref` element is used for referencing an enterprise bean that is accessed through its local business interface or no-interface view or local home and component interfaces.

The `ejb-ref` element contains the `description`, `ejb-ref-name`, `ejb-ref-type`, `home`, and `remote` elements.

The `ejb-local-ref` element contains the `description`, `ejb-ref-name`, `ejb-ref-type`, `local-home`, and `local` elements.

The `lookup-name` element specifies the JNDI name of the EJB reference's target session bean.

The `ejb-ref-name` element specifies the EJB reference name: its value is the environment entry name used in the enterprise bean code. The `ejb-ref-name` must be specified. The optional `ejb-ref-type` element specifies the expected type of the enterprise bean: its value must be either `Entity` or `Session`. The `home` and `remote` or `local-home` and `local` elements specify the expected Java types of the referenced enterprise bean's interface(s). If the reference is to an EJB 2.1 remote client view interface, the `home` element is required. Likewise, if the reference is to an EJB 2.1 local client view interface, the `local-home` element is required. The `remote` element of the `ejb-ref` element refers to either the business interface type or the component interface, depending on whether the reference is to a bean's EJB 3.x or EJB 2.1 remote client view. Likewise, the `local` element of the `ejb-local-ref` element refers to either the business interface type or bean class type or the component interface type, depending on whether the reference is to a bean's EJB 3.x local business interface, no-interface view, or EJB 2.1 local client view.

See Section 16.2.1 for the name scoping rules of EJB references.

The following example illustrates the declaration of EJB references in the deployment descriptor.

```

...
<enterprise-beans>
  <session>
    ...
    <ejb-name>EmployeeService</ejb-name>
    <ejb-class>com.wombat.empl.EmployeeServiceBean</ejb-class>
    ...
    <ejb-ref>
      <description>
        This is a reference to an EJB 2.1 entity bean that
        encapsulates access to employee records.
      </description>
      <ejb-ref-name>ejb/EmplRecord</ejb-ref-name>
      <ejb-ref-type>Entity</ejb-ref-type>
      <home>com.wombat.empl.EmployeeRecordHome</home>
      <remote>com.wombat.empl.EmployeeRecord</remote>
    </ejb-ref>

    <ejb-local-ref>
      <description>
        This is a reference to the local business interface
        of an EJB 3.0 session bean that provides a payroll
        service.
      </description>
      <ejb-ref-name>ejb/Payroll</ejb-ref-name>
      <local>com.aardvark.payroll.Payroll</local>
    </ejb-local-ref>

    <ejb-local-ref>
      <description>
        This is a reference to the local business interface
        of an EJB 3.0 session bean that provides a pension
        plan service.
      </description>
      <ejb-ref-name>ejb/PensionPlan</ejb-ref-name>
      <local>com.wombat.empl.PensionPlan</local>
    </ejb-local-ref>
    ...
  </session>
  ...
</enterprise-beans>
...

```

16.5.2 Application Assembler's Responsibilities

The Application Assembler can use the `ejb-link` element in the deployment descriptor to link an EJB reference to a target enterprise bean within the same application.

The Application Assembler specifies the link between two enterprise beans as follows:

- The Application Assembler uses the optional `ejb-link` element of the `ejb-ref` or `ejb-local-ref` element of the referencing enterprise bean. The value of the `ejb-link` element is the name of the target enterprise bean. (This is the bean name as defined by meta-data annotation (or default) in the bean class or in the `ejb-name` element of the target enter-

prise bean.) The target enterprise bean can be in any `ejb-jar` file or `.war` file in the same Java EE application as the referencing application component.

- Alternatively, to avoid the need to rename enterprise beans to have unique names within an entire Java EE application, the Application Assembler may use either of the following two syntaxes in the `ejb-link` element of the referencing application component. ^[89]
 - The Application Assembler specifies the `<module-name>` of the `ejb-jar` file or `.war` file containing the referenced enterprise bean and appends the `ejb-name` of the target bean separated by `/`. `<module-name>` is the base name of the bundle with no file-name extension, unless specified in the deployment descriptor.
 - The Application Assembler specifies the path name of the `ejb-jar` file or `.war` file containing the referenced enterprise bean and appends the `ejb-name` of the target bean separated from the path name by `#`. The path name is relative to the referencing application component jar file. In this manner, multiple beans with the same `ejb-name` may be uniquely identified when the Application Assembler cannot change `ejb-names`.
- Rather than using `ejb-link` to resolve the `ejb` reference, the Application Assembler may use the `lookup-name` element to reference the target EJB component by means of one of its JNDI names. It is an error for both `ejb-link` and `lookup-name` to appear inside an `ejb-ref` element.
- The Application Assembler must ensure that the target enterprise bean is type-compatible with the declared EJB reference. This means that the target enterprise bean must be of the type indicated in the `ejb-ref-type` element, if present, and that the business interface or bean class or home and component interfaces of the target enterprise bean must be Java type-compatible with the type declared in the EJB reference.

[89] The bean provider may also use this syntax in the `beanName` element of the EJB annotation.

The following illustrates an `ejb-link` in the deployment descriptor.

```

...
<enterprise-beans>
  <session>
    ...
    <ejb-name>EmployeeService</ejb-name>
    <ejb-class>com.wombat.empl.EmployeeServiceBean</ejb-class>
    ...
    <ejb-ref>
      <ejb-ref-name>ejb/EmplRecord</ejb-ref-name>
      <ejb-ref-type>Entity</ejb-ref-type>
      <home>com.wombat.empl.EmployeeRecordHome</home>
      <remote>com.wombat.empl.EmployeeRecord</remote>
      <ejb-link>EmployeeRecord</ejb-link>
    </ejb-ref>
    ...
  </session>
  ...

  <entity>
    <ejb-name>EmployeeRecord</ejb-name>
    <home>com.wombat.empl.EmployeeRecordHome</home>
    <remote>com.wombat.empl.EmployeeRecord</remote>
    ...
  </entity>
  ...
</enterprise-beans>
...

```

The Application Assembler uses the `ejb-link` element to indicate that the EJB reference `EmplRecord` declared in the `EmployeeService` enterprise bean has been linked to the `EmployeeRecord` enterprise bean.

The following example illustrates using the `ejb-link` element to indicate an enterprise bean reference to the `ProductEJB` enterprise bean that is in the same Java EE application unit but in a different `ejb-jar` file.

```

<entity>
  ...
  <ejb-name>OrderEJB</ejb-name>
  <ejb-class>com.wombat.orders.OrderBean</ejb-class>
  ...
  <ejb-ref>
    <ejb-ref-name>ejb/Product</ejb-ref-name>
    <ejb-ref-type>Entity</ejb-ref-type>
    <home>com.acme.orders.ProductHome</home>
    <remote>com.acme.orders.Product</remote>
    <ejb-link>../products/product.jar#ProductEJB</ejb-link>
  </ejb-ref>
  ...
</entity>

```

The following example illustrates using the `ejb-link` element to indicate an enterprise bean reference to the `ShoppingCart` enterprise bean that is in the same Java EE application unit but in a different `ejb-jar` file. The reference was originally declared in the bean's code using an annotation. The Application Assembler provides only the link to the bean.

```
...
<ejb-ref>
  <ejb-ref-name>ShoppingService/myCart</ejb-ref-name>
  <ejb-link>product/ShoppingCart</ejb-link>
</ejb-ref>
```

The same effect can be obtained by using the `lookup-name` element instead, using an appropriate JNDI name for the target bean.

```
...
<ejb-ref>
  <ejb-ref-name>ShoppingService/myCart</ejb-ref-name>
  <lookup-name>java:app/products/ShoppingCart</lookup-name>
</ejb-ref>
...
```

16.5.2.1 Overriding Rules

The following rules apply to how a deployment descriptor entry may override an EJB annotation:

- The relevant deployment descriptor entry is located based on the JNDI name used with the annotation (either defaulted or provided explicitly).
- The type specified in the deployment descriptor via the `remote`, `local`, `remote-home`, or `local-home` element and any bean referenced by the `ejb-link` element must be assignable to the type of the field or property or the type specified by the `beanInterface` element of the EJB annotation.
- The description, if specified, overrides the description element of the annotation.
- The injection target, if specified, must name exactly the annotated field or property method.

16.5.3 Deployer's Responsibility

The Deployer is responsible for the following:

- The Deployer must ensure that all the declared EJB references are bound to the business interfaces or no-interface views or homes of enterprise beans that exist in the operational environment. For session beans, the Deployer may use the EJB annotation `mappedName` attribute or the `ejb-ref/ejb-local-ref mapped-name` element to specify this binding. Section 4.4 describes the syntax for session bean portable global JNDI names. The Deployer may also use, for exam-

ple, the JNDI `LinkRef` mechanism to create a symbolic link to the actual JNDI name of the target enterprise bean.

- The Deployer must ensure that the target enterprise bean is type-compatible with the types declared for the EJB reference. This means that the target enterprise bean must be of the type indicated by the use of the `EJB` annotation, by the `ejb-ref-type` element (if specified), and that the business interface and no-interface view and/or home and component interfaces of the target enterprise bean must be Java type-compatible with the type of the injection target or the types declared in the EJB reference.
- If an EJB annotation includes the `beanName` element or the reference declaration includes the `ejb-link` element, the Deployer should bind the enterprise bean reference to the enterprise bean specified as the target.
- If an EJB annotation includes the `lookup` element or the reference declaration includes the `lookup-name` element, the Deployer should bind the enterprise bean reference to the enterprise bean specified as the target of the lookup. It is an error for an EJB reference declaration to include both an `ejb-link` and a `lookup-name` element.

The following example illustrates the use of the `lookup-name` element to bind an `ejb-ref` to a target enterprise bean in the operational environment. The reference was originally declared in the bean's code using an annotation. The target enterprise bean has `ejb-name` `ShoppingCart` and is deployed in the stand-alone module `products.jar`.

```
...
<ejb-ref>
  <ejb-ref-name>ShoppingService/myCart</ejb-ref-name>
  <lookup-name>java:global/products/ShoppingCart</lookup-name>
</ejb-ref>
```

16.5.4 Container Provider's Responsibility

The Container Provider must provide the deployment tools that allow the Deployer to perform the tasks described in the previous subsection. The deployment tools provided by the EJB Container Provider must be able to process the information supplied in the `ejb-ref` and `ejb-local-ref` elements in the deployment descriptor.

At the minimum, the tools must be able to:

- Preserve the application assembly information in annotations or in the `ejb-link` elements by binding an EJB reference to the business interface or the home interface of the specified target bean.
- Inform the Deployer of any unresolved EJB references, and allow him or her to resolve an EJB reference by binding it to a specified compatible target bean.

16.6 Web Service References

Web service references allow the Bean Provider to refer to external web services. The web service references are special entries in the enterprise bean's environment. The Deployer binds the web service references to the web service classes or interfaces in the target operational environment.

The specification of web service references and their usage is defined in the Java API for XML Web Services (JAX-WS) [32] and Web Services for Java EE specifications [31].

See Section 16.2.1 for the name scoping rules of web service references.

The EJB specification recommends, but does not require, that all references to web services be organized in the `service` subcontext of the bean's environment (i.e., in the `java:comp/env/service` JNDI context).

16.7 Resource Manager Connection Factory References

A resource manager connection factory is an object that is used to create connections to a resource manager. For example, an object that implements the `javax.sql.DataSource` interface is a resource manager connection factory for `java.sql.Connection` objects that implement connections to a database management system.

This section describes the metadata annotations and deployment descriptor elements that allow the enterprise bean code to refer to resource factories using logical names called *resource manager connection factory references*. The resource manager connection factory references are special entries in the enterprise bean's environment. The Deployer binds the resource manager connection factory references to the actual resource manager connection factories that are configured in the container. Because these resource manager connection factories allow the container to affect resource management, the connections acquired through the resource manager connection factory references are called *managed resources* (e.g., these resource manager connection factories allow the container to implement connection pooling and automatic enlistment of the connection with a transaction).

16.7.1 **Bean Provider's Responsibilities**

This subsection describes the Bean Provider's view of locating resource factories and defines his or her responsibilities. The first subsection describes annotations for injecting references to resource manager connection factories; the second describes the API for accessing resource manager connection references; and the third describes syntax for declaring the resource manager connection references in a deployment descriptor.

16.7.1.1 Injection of Resource Manager Connection Factory References

A field or a method of an enterprise bean may be annotated with the `Resource` annotation. The name and type of the factory are as described above in Section 16.2.2. The `authenticationType` and `shareable` elements of the `Resource` annotation may be used to control the type of authentication desired for the resource and the shareability of connections acquired from the factory, as described in the following sections.

The following code example illustrates how an enterprise bean uses annotations to declare resource manager connection factory references.

```
//The employee database.
@Resource javax.sql.DataSource employeeAppDB;
...
public void changePhoneNumber(...) {
    ...
    // Invoke factory to obtain a resource. The security
    // principal for the resource is not given, and
    // therefore it will be configured by the Deployer.
    java.sql.Connection con = employeeAppDB.getConnection();
    ...
}
```

16.7.1.2 Programming Interfaces for Resource Manager Connection Factory References

The Bean Provider must use resource manager connection factory references to obtain connections to resources as follows.

- Assign an entry in the enterprise bean's environment to the resource manager connection factory reference. (See subsection 16.7.1.3 for information on how resource manager connection factory references are declared in the deployment descriptor.)
- The EJB specification recommends, but does not require, that all resource manager connection factory references be organized in the subcontexts of the bean's environment, using a different subcontext for each resource manager type. For example, all JDBC™ `DataSource` references might be declared in the `java:comp/env/jdbc` subcontext, and all JMS connection factories in the `java:comp/env/jms` subcontext. Also, all JavaMail connection factories might be declared in the `java:comp/env/mail` subcontext and all URL connection factories in the `java:comp/env/url` subcontext. Note that resource manager connection factory references declared via annotations will not, by default, appear in any subcontext.
- Lookup the resource manager connection factory object in the enterprise bean's environment using the `EJBContext lookup` method or using the JNDI API.
- Invoke the appropriate method on the resource manager connection factory to obtain a connection to the resource. The factory method is specific to the resource type. It is possible to obtain multiple connections by calling the factory object multiple times.

The Bean Provider can control the shareability of the connections acquired from the resource manager connection factory. By default, connections to a resource manager are shareable across other enterprise beans in the application that use the same resource in the same transaction context. The Bean Provider can specify that connections obtained from a resource manager connection factory reference are not shareable by specifying the value of the `shareable` annotation element to `false` or the `res-sharing-scope` deployment descriptor element to be `Unshareable`. The sharing of connections to a resource manager allows the container to optimize the use of connections and enables the container's use of local transaction optimizations.

The Bean Provider has two choices with respect to dealing with associating a principal with the resource manager access:

- Allow the Deployer to set up principal mapping or resource manager sign-on information. In this case, the enterprise bean code invokes a resource manager connection factory method that has no security-related parameters.
- Sign on to the resource manager from the bean code. In this case, the enterprise bean invokes the appropriate resource manager connection factory method that takes the sign-on information as method parameters.

The Bean Provider uses the `authenticationType` annotation element or the `res-auth` deployment descriptor element to indicate which of the two resource manager authentication approaches is used.

We expect that the first form (i.e., letting the Deployer set up the resource manager sign-on information) will be the approach used by most enterprise beans.

The following code sample illustrates obtaining a JDBC connection when the `EJBContext lookup` method is used.

```
@Resource(name="jdbc/EmployeeAppDB", type=javax.sql.DataSource)
@Stateless public class EmployeeServiceBean
    implements EmployeeService {
    @Resource SessionContext ctx;

    public void changePhoneNumber(...) {
        ...
        // use context lookup to obtain resource manager
        // connection factory
        javax.sql.DataSource ds = (javax.sql.DataSource)
            ctx.lookup("jdbc/EmployeeAppDB");

        // Invoke factory to obtain a connection. The security
        // principal is not given, and therefore
        // it will be configured by the Deployer.
        java.sql.Connection con = ds.getConnection();
        ...
    }
}
```

The following code sample illustrates obtaining a JDBC connection when the JNDI APIs are used directly.

```
@Resource(name="jdbc/EmployeeAppDB", type=javax.sql.DataSource)
@Stateless public class EmployeeServiceBean
    implements EmployeeService {
    EJBContext ejbContext;

    public void changePhoneNumber(...) {
        ...
        // obtain the initial JNDI context
        Context initCtx = new InitialContext();

        // perform JNDI lookup to obtain resource manager
        // connection factory
        javax.sql.DataSource ds = (javax.sql.DataSource)
            initCtx.lookup("java:comp/env/jdbc/EmployeeAppDB");

        // Invoke factory to obtain a connection. The security
        // principal is not given, and therefore
        // it will be configured by the Deployer.
        java.sql.Connection con = ds.getConnection();
        ...
    }
}
```

16.7.1.3 Declaration of Resource Manager Connection Factory References in Deployment Descriptor

Although a resource manager connection factory reference is an entry in the enterprise bean's environment, the Bean Provider must not use an `env-entry` element to declare it.

Instead, if metadata annotations are not used, the Bean Provider must declare all the resource manager connection factory references in the deployment descriptor using the `resource-ref` elements. This allows the `ejb-jar` consumer (i.e. Application Assembler or Deployer) to discover all the resource manager connection factory references used by an enterprise bean. Deployment descriptor entries may also be used to specify injection of a resource manager connection factory reference into a bean.

Each `resource-ref` element describes a single resource manager connection factory reference. The `resource-ref` element consists of the `description` element; the mandatory `res-ref-name` element; and the optional `res-type`, `res-auth` and `res-sharing-scope` elements. The `res-ref-name` element contains the name of the environment entry used in the enterprise bean's code. The name of the environment entry is relative to the `java:comp/env` context (e.g., the name should be `jdbc/EmployeeAppDB` rather than `java:comp/env/jdbc/EmployeeAppDB`). The `res-type` element contains the Java type of the resource manager connection factory that the enterprise bean code expects. The `res-type` element is optional if an injection target is specified for the resource; in this case, the `res-type` defaults to the type of the injection target. The `res-auth` element indicates whether the enterprise bean code performs resource manager sign-on programmatically, or whether the container signs on to the resource manager using the principal mapping information supplied by the Deployer. The Bean Provider indicates the sign-on responsibility by setting the value of the `res-auth` element to `Application` or `Container`. If the `res-auth` element is not specified,

Container sign-on is assumed. The `res-sharing-scope` element indicates whether connections to the resource manager obtained through the given resource manager connection factory reference are to be shared or whether connections are unshareable. The value of the `res-sharing-scope` element is `Shareable` or `Unshareable`. If the `res-sharing-scope` element is not specified, connections are assumed to be shareable.

See Section 16.2.1 for the name scoping rules of resource manager connection factory references.

The type declaration allows the Deployer to identify the type of the resource manager connection factory.

Note that the indicated type is the Java type of the resource factory, not the Java type of the resource.

The following example is the declaration of resource manager connection factory references used by the `EmployeeService` enterprise bean illustrated in the previous subsection.

```

...
<enterprise-beans>
  <session>
    ...
    <ejb-name>EmployeeService</ejb-name>
    <ejb-class>com.wombat.empl.EmployeeServiceBean</ejb-class>
    ...
    <resource-ref>
      <description>
        A data source for the database in which
        the EmployeeService enterprise bean will
        record a log of all transactions.
      </description>
      <res-ref-name>jdbc/EmployeeAppDB</res-ref-name>
      <res-type>javax.sql.DataSource</res-type>
      <res-auth>Container</res-auth>
      <res-sharing-scope>Shareable</res-sharing-scope>
    </resource-ref>
    ...
  </session>
</enterprise-beans>
...

```

The following example illustrates the declaration of JMS resource manager connection factory references.

```

...
<enterprise-beans>
  <session>
    ...
    <resource-ref>
      <description>
        A queue connection factory used by the
        MySession enterprise bean to send
        notifications.
      </description>
      <res-ref-name>jms/qConnFactory</res-ref-name>
      <res-type>javax.jms.QueueConnectionFactory</res-type>
      <res-auth>Container</res-auth>
      <res-sharing-scope>Unshareable</res-sharing-scope>
    </resource-ref>
    ...
  </session>
</enterprise-beans>
...

```

16.7.1.4 Standard Resource Manager Connection Factory Types

The Bean Provider must use the `javax.sql.DataSource` resource manager connection factory type for obtaining JDBC connections, and the `javax.jms.ConnectionFactory`, `javax.jms.QueueConnectionFactory`, or `javax.jms.TopicConnectionFactory` for obtaining JMS connections.

The Bean Provider must use the `javax.mail.Session` resource manager connection factory type for obtaining JavaMail connections, and the `java.net.URL` resource manager connection factory type for obtaining URL connections.

It is recommended that the Bean Provider names JDBC data sources in the `java:comp/env/jdbc` subcontext, and JMS connection factories in the `java:comp/env/jms` subcontext. It is also recommended that the Bean Provider name all JavaMail connection factories in the `java:comp/env/mail` subcontext, and all URL connection factories in the `java:comp/env/url` subcontext. Note that resource manager connection factory references declared via annotations will not, by default, appear in any subcontext.

The Connector architecture [15] allows an enterprise bean to use the API described in this section to obtain resource objects that provide access to additional back-end systems.

16.7.2 Deployer's Responsibility

The Deployer uses deployment tools to bind the resource manager connection factory references to the actual resource factories configured in the target operational environment.

The Deployer must perform the following tasks for each resource manager connection factory reference declared in the metadata annotations or deployment descriptor:

- Bind the resource manager connection factory reference to a resource manager connection factory that exists in the operational environment. The Deployer may use, for example, the JNDI `LinkRef` mechanism to create a symbolic link to the actual JNDI name of the resource manager connection factory. The resource manager connection factory type must be compatible with the type declared in the source code or in the `res-type` element.
- Provide any additional configuration information that the resource manager needs for opening and managing the resource. The configuration mechanism is resource-manager specific, and is beyond the scope of this specification.
- If the value of the `Resource` annotation `authenticationType` element is `AuthenticationType.CONTAINER` or the deployment descriptor `res-auth` element is `Container`, the Deployer is responsible for configuring the sign-on information for the resource manager. This is performed in a manner specific to the EJB container and resource manager; it is beyond the scope of this specification.

For example, if principals must be mapped from the security domain and principal realm used at the enterprise beans application level to the security domain and principal realm of the resource manager, the Deployer or System Administrator must define the mapping. The mapping is performed in a manner specific to the EJB container and resource manager; it is beyond the scope of the current EJB specification.

16.7.3 Container Provider Responsibility

The EJB Container Provider is responsible for the following:

- Provide the deployment tools that allow the Deployer to perform the tasks described in the previous subsection.
- Provide the implementation of the resource manager connection factory classes for the resource managers that are configured with the EJB container.
- If the Bean Provider sets the `authenticationType` element of the `Resource` annotation to `AuthenticationType.APPLICATION` or the `res-auth` deployment descriptor entry for a resource manager connection factory reference to `Application`, the container must allow the bean to perform explicit programmatic sign-on using the resource manager's API.
- If the Bean Provider sets the `shareable` element of the `Resource` annotation to `false` or sets the `res-sharing-scope` deployment descriptor entry for a resource manager connection factory reference to `Unshareable`, the container must not attempt to share the connections obtained from the resource manager connection factory *reference*^[90]. If the Bean Provider sets the `res-sharing-scope` of a resource manager connection factory reference to `Shareable` or does not specify `res-sharing-scope`, the container must share the connections obtained from the resource manager connection factory according to the requirements defined in [12].

[90] Connections obtained from the same resource manager connection factory through a different resource manager connection factory reference may be shareable.

- The container must provide tools that allow the Deployer to set up resource manager sign-on information for the resource manager references whose annotation element `authenticationType` is set to `AuthenticationType.CONTAINER` or whose `res-auth` deployment descriptor element is set to `Container`. The minimum requirement is that the Deployer must be able to specify the user/password information for each resource manager connection factory reference declared by the enterprise bean, and the container must be able to use the user/password combination for user authentication when obtaining a connection to the resource by invoking the resource manager connection factory.

Although not required by the EJB specification, we expect that containers will support some form of a single sign-on mechanism that spans the application server and the resource managers. The container will allow the Deployer to set up the resource managers such that the EJB caller principal can be propagated (directly or through principal mapping) to a resource manager, if required by the application.

While not required by the EJB specification, most EJB container providers also provide the following features:

- A tool to allow the System Administrator to add, remove, and configure a resource manager for the EJB server.
- A mechanism to pool connections to the resources for the enterprise beans and otherwise manage the use of resources by the container. The pooling must be transparent to the enterprise beans.

16.7.4 System Administrator's Responsibility

The System Administrator is typically responsible for the following:

- Add, remove, and configure resource managers in the EJB server environment.

In some scenarios, these tasks can be performed by the Deployer.

16.8 Resource Environment References

This section describes the programming and deployment descriptor interfaces that allow the Bean Provider to refer to administered objects that are associated with resources (e.g., a `Connector CCI InteractionSpec` instance) by using “logical” names called *resource environment references*. Resource environment references are special entries in the enterprise bean's environment. The Deployer binds the resource environment references to administered objects in the target operational environment.

16.8.1 Bean Provider's Responsibilities

This subsection describes the Bean Provider's view and responsibilities with respect to resource environment references.

16.8.1.1 Injection of Resource Environment References

A field or a method of a bean may be annotated with the `Resource` annotation to request injection of a resource environment reference. The name and type of the resource environment reference are as described in Section 16.2.2. The `authenticationType` and `shareable` elements of the `Resource` annotation must not be specified; resource environment entries are not shareable and do not require authentication. The use of the `Resource` annotation to declare a resource environment reference differs from the use of the `Resource` annotation to declare simple environment references only in that the type of a resource environment reference is not one of the Java language types used for simple environment references.

16.8.1.2 Resource Environment Reference Programming Interfaces

The Bean Provider must use resource environment references to locate administered objects that are associated with resources, as follows.

- Assign an entry in the enterprise bean's environment to the reference. (See subsection 16.8.1.3 for information on how resource environment references are declared in the deployment descriptor.)
- The EJB specification recommends, but does not require, that all resource environment references be organized in the appropriate subcontext of the bean's environment for the resource type. Note that the resource environment references declared via annotations will not, by default, appear in any subcontext.
- Look up the administered object in the enterprise bean's environment using the `EJBContext.lookup` method or the JNDI API.

16.8.1.3 Declaration of Resource Environment References in Deployment Descriptor

Although the resource environment reference is an entry in the enterprise bean's environment, the Bean Provider must not use a `env-entry` element to declare it. Instead, the Bean Provider must declare all references to administered objects associated with resources using either annotations in the bean's source code or the `resource-env-ref` elements of the deployment descriptor. This allows the `ejb-jar` consumer to discover all the resource environment references used by the enterprise bean. Deployment descriptor entries may also be used to specify injection of a resource environment reference into a bean.

Each `resource-env-ref` element describes the requirements that the referencing enterprise bean has for the referenced administered object. The `resource-env-ref` element contains optional `description` and `resource-env-ref-type` elements, and the mandatory `resource-env-ref-name` element. The `resource-env-ref-type` element is optional if an injection target is specified for the resource environment reference; in this case the `resource-env-ref-type` defaults to the type of the injection target.

The `resource-env-ref-name` element specifies the resource environment reference name: its value is the environment entry name used in the enterprise bean code. The name of the environment entry is relative to the `java:comp/env` context. The `resource-env-ref-type` element specifies the expected type of the referenced object.

See Section 16.2.1 for the name scoping rules of resource environment references.

16.8.2 Deployer's Responsibility

The Deployer is responsible for the following:

- The Deployer must ensure that all the declared resource environment references are bound to administered objects that exist in the operational environment. The Deployer may use, for example, the JNDI `LinkRef` mechanism to create a symbolic link to the actual JNDI name of the target object.
- The Deployer must ensure that the target object is type-compatible with the type declared for the resource environment reference. This means that the target object must be of the type indicated in the `Resource` annotation or the `resource-env-ref-type` element.

16.8.3 Container Provider's Responsibility

The Container Provider must provide the deployment tools that allow the Deployer to perform the tasks described in the previous subsection. The deployment tools provided by the EJB Container Provider must be able to process the information supplied in the class file annotations and `resource-env-ref` elements in the deployment descriptor.

At the minimum, the tools must be able to inform the Deployer of any unresolved resource environment references, and allow him or her to resolve a resource environment reference by binding it to a specified compatible target object in the environment.

16.9 Message Destination References

This section describes the programming and deployment descriptor interfaces that allow the Bean Provider to refer to message destination objects by using “logical” names called *message destination references*. Message destination references are special entries in the enterprise bean's environment. The Deployer binds the message destination references to administered message destinations in the target operational environment.

16.9.1 Bean Provider's Responsibilities

This subsection describes the Bean Provider's view and responsibilities with respect to message destination references.

16.9.1.1 Injection of Message Destination References

A field or a method of a bean may be annotated with the `Resource` annotation to request injection of a message destination reference. The name and type of the resource environment reference are as described in Section 16.2.2. The `authenticationType` and `shareable` elements of the `Resource` annotation must not be specified.

Note that when using the `Resource` annotation to declare a message destination reference it is not possible to link the reference to other references to the same message destination, or to specify whether the destination is used to produce or consume messages. The deployment descriptor entries described in Section 16.9.1.3 provide a way to associate multiple message destination references with a single message destination and to specify whether each message destination reference is used to produce, consume, or both produce and consume messages, so that the entire message flow of an application may be specified. The Application Assembler may use these message destination links to link together message destination references that have been declared using the `Resource` annotation. A message destination reference declared via the `Resource` annotation is assumed to be used to both produce and consume messages; this default may be overridden using a deployment descriptor entry.

The following example illustrates how an enterprise bean uses the `Resource` annotation to request injection of a message destination reference.

```
@Resource javax.jms.Queue stockQueue;
```

16.9.1.2 Message Destination Reference Programming Interfaces

The Bean Provider uses message destination references to locate message destinations, as follows.

- Assign an entry in the enterprise bean's environment to the reference. (See subsection 16.9.1.3 for information on how message destination references are declared in the deployment descriptor.)
- The EJB specification recommends, but does not require, that all message destination references be organized in the appropriate subcontext of the bean's environment for the messaging resource type (e.g. in the `java:comp/env/jms` JNDI context for JMS Destinations). Note that message destination references declared via annotations will not, by default, appear in any subcontext.
- Look up the destination in the enterprise bean's environment using the `EJBContext lookup` method or the JNDI APIs.

The following example illustrates how an enterprise bean uses a message destination reference to locate a JMS Destination.

```
@Resource(name="jms/StockQueue", type=javax.jms.Queue)
@Stateless public class StockServiceBean implements StockService {

    @Resource SessionContext ctx;

    public void processStockInfo(...) {
        ...
        // Look up the JMS StockQueue in the environment.
        Object result = ctx.lookup("jms/StockQueue");

        // Convert the result to the proper type.
        javax.jms.Queue queue = (javax.jms.Queue)result;
    }
}
```

In the example, the Bean Provider of the `StockServiceBean` enterprise bean has assigned the environment entry `jms/StockQueue` as the message destination reference name to refer to a JMS queue.

If the JNDI APIs were used directly, the example would be as follows.

```
@Resource(name="jms/StockQueue", type=javax.jms.Queue)
@Stateless public class StockServiceBean implements StockService {

    public void processStockInfo(...) {
        ...
        // Obtain the default initial JNDI context.
        Context initCtx = new InitialContext();

        // Look up the JMS StockQueue in the environment.
        Object result = initCtx.lookup(
            "java:comp/env/jms/StockQueue");

        // Convert the result to the proper type.
        javax.jms.Queue queue = (javax.jms.Queue)result;
        ...
    }
}
```

16.9.1.3 Declaration of Message Destination References in Deployment Descriptor

Although the message destination reference is an entry in the enterprise bean's environment, the Bean Provider must not use a `env-entry` element to declare it. Instead, the Bean Provider should declare all references to message destinations using either the `Resource` annotation in the bean's code or the `message-destination-ref` elements of the deployment descriptor. This allows the `ejb-jar` consumer to discover all the message destination references used by the enterprise bean. Deployment descriptor entries may also be used to specify injection of a message destination reference into a bean.

Each `message-destination-ref` element describes the requirements that the referencing enterprise bean has for the referenced destination. The `message-destination-ref` element contains optional `description`, `message-destination-type`, and `message-destination-usage` elements, and the mandatory `message-destination-ref-name` element.

The `message-destination-ref-name` element specifies the message destination reference name: its value is the environment entry name used in the enterprise bean code. The name of the message destination reference is relative to the `java:comp/env` context (e.g., the name should be `jms/StockQueue` rather than `java:comp/env/jms/StockQueue`). The `message-destination-type` element specifies the expected type of the referenced destination. For example, in the case of a JMS Destination, its value might be `javax.jms.Queue`. The `message-destination-type` element is optional if an injection target is specified for the message destination reference; in this case the `message-destination-type` defaults to the type of the injection target. The `message-destination-usage` element specifies whether messages are consumed from the message destination, produced for the destination, or both. If the `message-destination-usage` element is not specified, messages are assumed to be both consumed and produced.

See Section 16.2.1 for the name scoping rules of message destination references.

The following example illustrates the declaration of message destination references in the deployment descriptor.

```
...
<message-destination-ref>
  <description>
    This is a reference to a JMS queue used in processing Stock info
  </description>
  <message-destination-ref-name>
    jms/StockInfo
  </message-destination-ref-name>
  <message-destination-type>
    javax.jms.Queue
  </message-destination-type>
  <message-destination-usage>
    Produces<
      /message-destination-usage>
</message-destination-ref>
...
```

16.9.2 Application Assembler's Responsibilities

By means of linking message consumers and producers to one or more common logical destinations specified in the deployment descriptor, the Application Assembler can specify the flow of messages within an application. The Application Assembler uses the `message-destination` element, the `message-destination-link` element of the `message-destination-ref` element, and the `message-destination-link` element of the `message-driven` element to link message destination references to a common logical destination.

The Application Assembler specifies the link between message consumers and producers as follows:

- The Application Assembler uses the `message-destination` element to specify a logical message destination within the application. The `message-destination` element defines a `message-destination-name`, which is used for the purpose of linking.
- The Application Assembler uses the `message-destination-link` element of the `message-destination-ref` element of an enterprise bean that produces messages to link it to the target destination. The value of the `message-destination-link` element is the name of the target destination, as defined in the `message-destination-name` element of the `message-destination` element. The `message-destination` element can be in any module in the same Java EE application as the referencing component. The Application Assembler uses the `message-destination-usage` element of the `message-destination-ref` element to indicate that the referencing enterprise bean produces messages to the referenced destination.
- If the consumer of messages from the common destination is a message-driven bean, the Application Assembler uses the `message-destination-link` element of the `message-driven` element to reference the logical destination. If the Application Assembler links a message-driven bean to its source destination, he or she should use the `message-destination-type` element of the `message-driven` element to specify the expected destination type.

- If an enterprise bean is otherwise a message consumer, the Application Assembler uses the `message-destination-link` element of the `message-destination-ref` element of the enterprise bean that consumes messages to link to the common destination. In the latter case, the Application Assembler uses the `message-destination-usage` element of the `message-destination-ref` element to indicate that the enterprise bean consumes messages from the referenced destination.
- To avoid the need to rename message destinations to have unique names within an entire Java EE application, the Application Assembler may use the following syntax in the `message-destination-link` element of the referencing application component. The Application Assembler specifies the path name of the `ejb-jar` file containing the referenced message destination and appends the `message-destination-name` of the target destination separated from the path name by `#`. The path name is relative to the referencing application component `jar` file. In this manner, multiple destinations with the same `message-destination-name` may be uniquely identified.
- When linking message destinations, the Application Assembler must ensure that the consumers and producers for the destination require a message destination of the same or compatible type, as determined by the messaging system.

The following example illustrates the use of message destination linking in the deployment descriptor.

```

...
<enterprise-beans>
<session>
  ...
  <ejb-name>EmployeeService</ejb-name>
  <ejb-class>com.wombat.empl.EmployeeServiceBean</ejb-class>
  ...
  <message-destination-ref>
    <message-destination-ref-name>
      jms/EmployeeReimbursements
    </message-destination-ref-name>
    <message-destination-type>
      javax.jms.Queue
    </message-destination-type>
    <message-destination-usage>
      Produces
    </message-destination-usage>
    <message-destination-link>
      ExpenseProcessingQueue
    </message-destination-link>
  </message-destination-ref>
</session>
...

<message-driven>
  <ejb-name>ExpenseProcessing</ejb-name>
  <ejb-class>com.wombat.empl.ExpenseProcessingBean</ejb-class>
  <messaging-type>javax.jms.MessageListener</messaging-type>
  ...
  <message-destination-type>
    javax.jms.Queue
  </message-destination-type>
  <message-destination-link>
    ExpenseProcessingQueue
  </message-destination-link>
  ...
</message-driven>
...
</enterprise-beans>
...
<assembly-descriptor>
  ...
  <message-destination>
    <message-destination-name>
      ExpenseProcessingQueue
    </message-destination-name>
  </message-destination>
  ...
</assembly-descriptor>

```

The Application Assembler uses the `message-destination-link` element to indicate that the message destination reference `EmployeeReimbursement` declared in the `EmployeeService` enterprise bean is linked to the `ExpenseProcessing` message-driven bean by means of the common destination `ExpenseProcessingQueue`.

The following example illustrates using the `message-destination-link` element to indicate an enterprise bean reference to the `ExpenseProcessingQueue` that is in the same Java EE application unit but in a different `ejb-jar` file.

```
<session>
  ...
  <ejb-name>EmployeeService</ejb-name>
  <ejb-class>com.wombat.empl.EmployeeServiceBean</ejb-class>
  ...
  <message-destination-ref>
    <message-destination-ref-name>
      jms/EmployeeReimbursements
    </message-destination-ref-name>
    <message-destination-type>
      javax.jms.Queue
    </message-destination-type>
    <message-destination-usage>
      Produces
    </message-destination-usage>
    <message-destination-link>
      finance.jar#ExpenseProcessingQueue
    </message-destination-link>
  </message-destination-ref>
</session>
```

16.9.3 Deployer's Responsibility

The Deployer is responsible for the following:

- The Deployer must ensure that all the declared message destination references are bound to destination objects that exist in the operational environment. The Deployer may use, for example, the JNDI `LinkRef` mechanism to create a symbolic link to the actual JNDI name of the target object.
- The Deployer must ensure that the target object is type-compatible with the type declared for the message destination reference.
- The Deployer must observe the message destination links specified by the Application Assembler.

16.9.4 Container Provider's Responsibility

The Container Provider must provide the deployment tools that allow the Deployer to perform the tasks described in the previous subsection. The deployment tools provided by the EJB Container Provider must be able to process the information supplied in the `message-destination-ref` and `message-destination-link` elements in the deployment descriptor.

The tools must be able to inform the Deployer of the message flow between consumers and producers sharing common message destinations. The tools must also be able to inform the Deployer of any unresolved message destination references, and allow him or her to resolve a message destination reference by binding it to a specified compatible target object in the environment.

16.10 Persistence Unit References

This section describes the metadata annotations and deployment descriptor elements that allow the enterprise bean code to refer to the entity manager factory for a persistence unit using a logical name called a *persistence unit reference*. Persistence unit references are special entries in the enterprise bean's environment. The Deployer binds the persistence unit references to entity manager factories that are configured in accordance with the `persistence.xml` specification for the persistence unit, as described in the document “*Java Persistence API*” of this specification [2].

16.10.1 Bean Provider's Responsibilities

This subsection describes the Bean Provider's view of locating the entity manager factory for a persistence unit and defines his or her responsibilities. The first subsection describes annotations for injecting references to an entity manager factory for a persistence unit; the second describes the API for accessing an entity manager factory using a persistence unit reference; and the third describes syntax for declaring persistence unit references in a deployment descriptor.

16.10.1.1 Injection of Persistence Unit References

A field or a method of an enterprise bean may be annotated with the `PersistenceUnit` annotation. The `name` element specifies the name under which the entity manager factory for the referenced persistence unit may be located in the JNDI naming context. The optional `unitName` element specifies the name of the persistence unit as declared in the `persistence.xml` file that defines the persistence unit.

The following code example illustrates how an enterprise bean uses annotations to declare persistence unit references.

```
@PersistenceUnit
EntityManagerFactory emf;

@PersistenceUnit(unitName="InventoryManagement")
EntityManagerFactory inventoryEMF;
```

16.10.1.2 Programming Interfaces for Persistence Unit References

The Bean Provider must use persistence unit references to obtain references to entity manager factories as follows.

- Assign an entry in the enterprise bean's environment to the persistence unit reference. (See subsection 16.10.1.3 for information on how persistence unit references are declared in the deployment descriptor.)
- The EJB specification recommends, but does not require, that all persistence unit references be organized in the `java:comp/env/persistence` subcontexts of the bean's environment.
- Lookup the entity manager factory for the persistence unit in the enterprise bean's environment using the `EJBContext lookup` method or using the JNDI API.

The following code sample illustrates obtaining an entity manager factory when the `EJBContext` lookup method is used.

```
@PersistenceUnit(name="persistence/InventoryAppDB")
@Stateless
public class InventoryManagerBean implements InventoryManager {
    @Resource SessionContext ctx;

    public void updateInventory(...) {
        ...
        // use context lookup to obtain entity manager factory
        EntityManagerFactory emf = (EntityManagerFactory)
            ctx.lookup("persistence/InventoryAppDB");

        // use factory to obtain application-managed entity manager
        EntityManager em = emf.createEntityManager();
        ...
    }
}
```

The following code sample illustrates obtaining an entity manager factory when the JNDI APIs are used directly.

```
@PersistenceUnit(name="persistence/InventoryAppDB")
@Stateless
public class InventoryManagerBean implements InventoryManager {
    EJBContext ejbContext;
    ...
    public void updateInventory(...) {
        ...
        // obtain the initial JNDI context
        Context initCtx = new InitialContext();

        // perform JNDI lookup to obtain entity manager factory
        EntityManagerFactory emf = (EntityManagerFactory)
            initCtx.lookup("java:comp/env/persistence/InventoryAp-
pDB");

        // use factory to obtain application-managed entity manager
        EntityManager em = emf.createEntityManager();
        ...
    }
}
```

16.10.1.3 Declaration of Persistence Unit References in Deployment Descriptor

Although a persistence unit reference is an entry in the enterprise bean's environment, the Bean Provider must not use an `env-entry` element to declare it.

Instead, if metadata annotations are not used, the Bean Provider must declare all the persistence unit references in the deployment descriptor using the `persistence-unit-ref` elements. This allows the `ejb-jar` consumer (i.e. Application Assembler or Deployer) to discover all the persistence unit references used by an enterprise bean. Deployment descriptor entries may also be used to specify injection of a persistence unit reference into a bean.

Each `persistence-unit-ref` element describes a single entity manager factory reference for the persistence unit. The `persistence-unit-ref` element consists of the optional `description` and `persistence-unit-name` elements, and the mandatory `persistence-unit-ref-name` element.

The `persistence-unit-ref-name` element contains the name of the environment entry used in the enterprise bean's code. The name of the environment entry is relative to the `java:comp/env` context (e.g., the name should be `persistence/InventoryAppDB` rather than `java:comp/env/persistence/InventoryAppDB`). The optional `persistence-unit-name` element is the name of the persistence unit, as specified in the `persistence.xml` file for the persistence unit.

The following example is the declaration of a persistence unit reference used by the `InventoryManager` enterprise bean illustrated in the previous subsection.

```

...
<enterprise-beans>
  <session>
    ...
    <ejb-name>InventoryManagerBean</ejb-name>
    <ejb-class>
      com.wombat.empl.InventoryManagerBean
    </ejb-class>
    ...
    <persistence-unit-ref>
      <description>
        Persistence unit for the inventory management
        application.
      </description>
      <persistence-unit-ref-name>
        persistence/InventoryAppDB
      </persistence-unit-ref-name>
      <persistence-unit-name>
        InventoryManagement
      </persistence-unit-name>
    </persistence-unit-ref>
    ...
  </session>
</enterprise-beans>
...

```

16.10.2 Application Assembler's Responsibilities

The Application Assembler can use the `persistence-unit-name` element in the deployment descriptor to specify a reference to a persistence unit. The Application Assembler (or Bean Provider) may use the following syntax in the `persistence-unit-name` element of the referencing application component to avoid the need to rename persistence units to have unique names within a Java EE application. The Application Assembler specifies the path name of the root of the referenced persistence unit and appends the name of the persistence unit separated from the path name by `#`. The path name is relative to the referencing application component jar file. In this manner, multiple persistence units with the same persistence unit name may be uniquely identified when persistence unit names cannot be changed.

For example,

```

...
<enterprise-beans>
  <session>
    ...
    <ejb-name>InventoryManagerBean</ejb-name>
    <ejb-class>
      com.wombat.empl.InventoryManagerBean
    </ejb-class>
    ...
    <persistence-unit-ref>
      <description>
        Persistence unit for the inventory management
        application.
      </description>
      <persistence-unit-ref-name>
        persistence/InventoryAppDB
      </persistence-unit-ref-name>
      <persistence-unit-name>
        ../lib/inventory.jar#InventoryManagement
      </persistence-unit-name>
    </persistence-unit-ref>
    ...
  </session>
</enterprise-beans>
...

```

The Application Assembler uses the `persistence-unit-name` element to link the persistence unit name `InventoryManagement` declared in the `InventoryManagerBean` to the persistence unit named `InventoryManagement` defined in `inventory.jar`.

16.10.2.1 Overriding Rules

The following rules apply to how a deployment descriptor entry may override a `PersistenceUnit` annotation:

- The relevant deployment descriptor entry is located based on the JNDI name used with the annotation (either defaulted or provided explicitly).
- The `persistence-unit-name` overrides the `unitName` element of the annotation. The Application Assembler or Deployer should exercise caution in changing this value, if specified, as doing so is likely to break the application.
- The injection target, if specified, must name exactly the annotated field or property method.

16.10.3 Deployer's Responsibility

The Deployer uses deployment tools to bind a persistence unit reference to the actual entity manager factory configured for the persistence in the target operational environment.

The Deployer must perform the following tasks for each persistence unit reference declared in the meta-data annotations or deployment descriptor:

- Bind the persistence unit reference to an entity manager factory configured for the persistence unit that exists in the operational environment. The Deployer may use, for example, the JNDI `LinkRef` mechanism to create a symbolic link to the actual JNDI name of the entity manager factory.
- If the persistence unit name is specified, the Deployer should bind the persistence unit reference to the entity manager factory for the persistence unit specified as the target.
- Provide any additional configuration information that the entity manager factory needs for managing the persistence unit, as described in [2].

16.10.4 Container Provider Responsibility

The EJB Container Provider is responsible for the following:

- Provide the deployment tools that allow the Deployer to perform the tasks described in the previous subsection.
- Provide the implementation of the entity manager factory classes for the persistence units that are configured with the EJB container. The implementation of the entity manager factory classes may be provided by the container directly or by the container in conjunction with a third-party persistence provider, as described in [2].

16.10.5 System Administrator's Responsibility

The System Administrator is typically responsible for the following:

- Add, remove, and configure entity manager factories in the EJB server environment.

In some scenarios, these tasks can be performed by the Deployer.

16.11 Persistence Context References

This section describes the metadata annotations and deployment descriptor elements that allow the enterprise bean code to refer to a container-managed entity manager of a specified persistence context type using a logical name called a *persistence context reference*. Persistence context references are special entries in the enterprise bean's environment. The Deployer binds the persistence context references to container-managed entity managers for persistence contexts of the specified type and configured in accordance with their persistence unit, as described in the document "*Java Persistence API*" of this specification [2].

16.11.1 Bean Provider's Responsibilities

This subsection describes the Bean Provider's view of locating container-managed entity managers and defines his or her responsibilities. The first subsection describes annotations for injecting references to container-managed entity managers; the second describes the API for accessing references to container-managed entity managers; and the third describes syntax for declaring these references in a deployment descriptor.

16.11.1.1 Injection of Persistence Context References

A field or a method of an enterprise bean may be annotated with the `PersistenceContext` annotation. The `name` element specifies the name under which a container-managed entity manager for the referenced persistence unit may be located in the JNDI naming context. The optional `unitName` element specifies the name of the persistence unit as declared in the `persistence.xml` file that defines the persistence unit. The optional `type` element specifies whether a transaction-scoped or extended persistence context is to be used. If the type is not specified, a transaction-scoped persistence context will be used. References to container-managed entity managers with extended persistence contexts can only be injected into stateful session beans. The optional `properties` element specifies configuration properties to be passed to the persistence provider when the entity manager is created.

The following code example illustrates how an enterprise bean uses annotations to declare persistence context references.

```
@PersistenceContext(type=EXTENDED)
EntityManager em;
```

16.11.1.2 Programming Interfaces for Persistence Context References

The Bean Provider must use persistence context references to obtain references to a container-managed entity manager configured for a persistence unit as follows:

- Assign an entry in the enterprise bean's environment to the persistence context reference. (See subsection 16.11.1.3 for information on how persistence context references are declared in the deployment descriptor.)
- The EJB specification recommends, but does not require, that all persistence context references be organized in the `java:comp/env/persistence` subcontexts of the bean's environment.
- Lookup the container-managed entity manager for the persistence unit in the enterprise bean's environment using the `EJBContext lookup` method or using the JNDI API.

The following code sample illustrates obtaining an entity manager for a persistence context when the `EJBContext` lookup method is used.

```
@PersistenceContext(name="persistence/InventoryAppMgr")
@Stateless
public class InventoryManagerBean implements InventoryManager {
    @Resource SessionContext ctx;

    public void updateInventory(...) {
        ...
        // use context lookup to obtain container-managed entity
manager      EntityManager em =(EntityManager)
                ctx.lookup("persistence/InventoryAppMgr");
        ...
    }
}
```

The following code sample illustrates obtaining an entity manager when the JNDI APIs are used directly.

```
@PersistenceContext(name="persistence/InventoryAppMgr")
@Stateless
public class InventoryManagerBean implements InventoryManager {
    EJBContext ejbContext;

    public void updateInventory(...) {
        ...
        // obtain the initial JNDI context
Context      initCtx = new InitialContext();

        // perform JNDI lookup to obtain container-managed entity
manager      EntityManager em = (EntityManager)
                initCtx.lookup("java:comp/env/persistence/InventoryApp-
Mgr");
        ...
    }
}
```

16.11.1.3 Declaration of Persistence Context References in Deployment Descriptor

Although a persistence context reference is an entry in the enterprise bean's environment, the Bean Provider must not use an `env-entry` element to declare it.

Instead, if metadata annotations are not used, the Bean Provider must declare all the persistence context references in the deployment descriptor using the `persistence-context-ref` elements. This allows the `ejb-jar` consumer (i.e. Application Assembler or Deployer) to discover all the persistence context references used by an enterprise bean. Deployment descriptor entries may also be used to specify injection of a persistence context reference into a bean.

Each `persistence-context-ref` element describes a single container-managed entity manager reference. The `persistence-context-ref` element consists of the optional `description`, `persistence-unit-name`, `persistence-context-type` and `persistence-property` elements, and the mandatory `persistence-context-ref-name` element.

The `persistence-context-ref-name` element contains the name of the environment entry used in the enterprise bean's code. The name of the environment entry is relative to the `java:comp/env` context (e.g., the name should be `persistence/InventoryAppMgr` rather than `java:comp/env/persistence/InventoryAppMgr`). The `persistence-unit-name` element is the name of the persistence unit, as specified in the `persistence.xml` file for the persistence unit. The `persistence-context-type` element specifies whether a transaction-scoped or extended persistence context is to be used. Its value is either `Transaction` or `Extended`. If the persistence context type is not specified, a transaction-scoped persistence context will be used. The optional `persistence-property` elements specify configuration properties that are passed to the persistence provider when the entity manager is created.

The following example is the declaration of a persistence context reference used by the `InventoryManager` enterprise bean illustrated in the previous subsection.

```
...
<enterprise-beans>
  <session>
    ...
    <ejb-name>InventoryManagerBean</ejb-name>
    <ejb-class>
      com.wombat.empl.InventoryManagerBean
    </ejb-class>
    ...
    <persistence-context-ref>
      <description>
        Persistence context for the inventory management
        application.
      </description>
      <persistence-context-ref-name>
        persistence/InventoryAppMgr
      </persistence-context-ref-name>
      <persistence-unit-name>
        InventoryManagement
      </persistence-unit-name>
    </persistence-context-ref>
    ...
  </session>
</enterprise-beans>
...
```

16.11.2 Application Assembler's Responsibilities

The Application Assembler can use the `persistence-unit-name` element in the deployment descriptor to specify a reference to a persistence unit using the syntax described in section 16.10.2. In this manner, multiple persistence units with the same persistence unit name may be uniquely identified when persistence unit names cannot be changed.

For example,

```

...
<enterprise-beans>
  <session>
    ...
    <ejb-name>InventoryManagerBean</ejb-name>
    <ejb-class>
      com.wombat.empl.InventoryManagerBean
    </ejb-class>
    ...
    <persistence-context-ref>
      <description>
        Persistence context for the inventory management
        application.
      </description>
      <persistence-context-ref-name>
        persistence/InventoryAppMgr
      </persistence-context-ref-name>
      <persistence-unit-name>
        ../lib/inventory.jar#InventoryManagement
      </persistence-unit-name>
    </persistence-context-ref>
    ...
  </session>
</enterprise-beans>
...

```

The Application Assembler uses the `persistence-unit-name` element to link the persistence unit name `InventoryManagement` declared in the `InventoryManagerBean` to the persistence unit named `InventoryManagement` defined in `inventory.jar`.

16.11.2.1 Overriding Rules

The following rules apply to how a deployment descriptor entry may override a `PersistenceContext` annotation:

- The relevant deployment descriptor entry is located based on the JNDI name used with the annotation (either defaulted or provided explicitly).
- The `persistence-unit-name` overrides the `unitName` element of the annotation. The Application Assembler or Deployer should exercise caution in changing this value, if specified, as doing so is likely to break the application.
- The `persistence-context-type`, if specified, overrides the `type` element of the annotation. In general, the Application Assembler or Deployer should never change the value of this element, as doing so is likely to break the application.

- Any `persistence-property` elements are added to those specified by the `PersistenceContext` annotation. If the name of a specified property is the same as one specified by the `PersistenceContext` annotation, the value specified in the annotation is overridden.
- The injection target, if specified, must name exactly the annotated field or property method.

16.11.3 Deployer's Responsibility

The Deployer uses deployment tools to bind a persistence context reference to the container-managed entity manager for the persistence context of the specified type and configured for the persistence unit in the target operational environment.

The Deployer must perform the following tasks for each persistence context reference declared in the metadata annotations or deployment descriptor:

- Bind the persistence context reference to a container-managed entity manager for a persistence context of the specified type and configured for the persistence unit as specified in the `persistence.xml` file for the persistence unit that exists in the operational environment. The Deployer may use, for example, the JNDI `LinkRef` mechanism to create a symbolic link to the actual JNDI name of the entity manager.
- If the persistence unit name is specified, the Deployer should bind the persistence context reference to an entity manager for the persistence unit specified as the target.
- Provide any additional configuration information that the entity manager factory needs for creating such an entity manager and for managing the persistence unit, as described in [2].

16.11.4 Container Provider Responsibility

The EJB Container Provider is responsible for the following:

- Provide the deployment tools that allow the Deployer to perform the tasks described in the previous subsection.
- Provide the implementation of the entity manager classes for the persistence units that are configured with the EJB container. This implementation may be provided by the container directory or by the container in conjunction with a third-party persistence provider, as described in [2].

16.11.5 System Administrator's Responsibility

The System Administrator is typically responsible for the following:

- Add, remove, and configure entity manager factories in the EJB server environment.

In some scenarios, these tasks can be performed by the Deployer.

16.12 UserTransaction Interface

The container must make the `UserTransaction` interface available to the enterprise beans that are allowed to use this interface (only session and message-driven beans with bean-managed transaction demarcation are allowed to use this interface) either through injection using the `Resource` annotation or in JNDI under the name `java:comp/UserTransaction`, in addition to through the `EJBContext` interface. The `authenticationType` and `shareable` elements of the `Resource` annotation must not be specified.

The container must not make the `UserTransaction` interface available to the enterprise beans that are not allowed to use this interface. The container should throw `javax.naming.NameNotFoundException` if an instance of an enterprise bean that is not allowed to use the `UserTransaction` interface attempts to look up the interface in JNDI using the JNDI APIs.

The following example illustrates how an enterprise bean acquires and uses a `UserTransaction` object via injection.

```
@Resource UserTransaction tx;
...
public void updateData(...) {
    ...
    // Start a transaction.
    tx.begin();
    ...
    // Perform transactional operations on data.
    ...
    // Commit the transaction.
    tx.commit();
    ...
}
```

The following code example

```
public MySessionBean implements SessionBean {
    ...
    public someMethod()
    {
        ...
        Context initCtx = new InitialContext();
        UserTransaction utx = (UserTransaction) initCtx.lookup(
            "java:comp/UserTransaction");
        utx.begin();
        ...
        utx.commit();
    }
    ...
}
```

is functionally equivalent to

```
public MySessionBean implements SessionBean {
    ...
    SessionContext ctx;
    ...
    public someMethod()
    {
        UserTransaction utx = ctx.getUserTransaction();
        utx.begin();
        ...
        utx.commit();
    }
    ...
}
```

A `UserTransaction` object reference may also be declared in a deployment descriptor in the same way as a resource environment reference. Such a deployment descriptor entry may be used to specify injection of a `UserTransaction` object.

16.12.1 Bean Provider's Responsibility

The Bean Provider is responsible for requesting injection of a `UserTransaction` object using a `Resource` annotation or for using the defined name to lookup the `UserTransaction` object.

16.12.2 Container Provider's Responsibility

The Container Provider is responsible for providing an appropriate `UserTransaction` object as required by this specification.

16.13 ORB References

Enterprise beans that need to make use of the CORBA ORB to perform certain operations can find an appropriate object implementing the ORB interface by requesting injection of an ORB object or by looking up the JNDI name `java:comp/ORB`. Any such reference to an ORB object is only valid within the bean instance that performed the lookup.

The following example illustrates how an application component acquires and uses an ORB object via injection.

```
@Resource ORB orb;

public void method(...) {
    ...
    // Get the POA to use when creating object references.
    POA rootPOA = (POA)orb.resolve_initial_references("RootPOA");
    ...
}
```

The following example illustrates how an enterprise bean acquires and uses an ORB object using a JNDI lookup.

```
public void method(...) {
    ...
    // Obtain the default initial JNDI context.
    Context initCtx = new InitialContext();

    // Look up the ORB object.
    ORB orb = (ORB) initCtx.lookup("java:comp/ORB");

    // Get the POA to use when creating object references.
    POA rootPOA = (POA) orb.resolve_initial_references("RootPOA");
    ...
}
```

An ORB reference may also be declared in a deployment descriptor in the same way as a resource manager connection factory reference. Such a deployment descriptor entry may be used to specify injection of an ORB object.

The ORB instance available under the JNDI name `java:comp/ORB` may always be a shared instance. By default, the ORB instance injected into an enterprise bean or declared via a deployment descriptor entry may also be a shared instance. However, the application may set the `shareable` element of the `Resource` annotation to `false`, or may set the `res-sharing-scope` element in the deployment descriptor to `Unshareable`, to request a non-shared ORB instance.

16.13.1 Bean Provider's Responsibility

The Bean Provider is responsible for requesting injection of the ORB object using the `Resource` annotation, or using the defined name to look up the ORB object. If the `shareable` element of the `Resource` annotation is set to `false`, the ORB object injected will not be the shared instance used by other components in the application but instead will be a private ORB instance used only by the given component.

16.13.2 Container Provider's Responsibility

The Container Provider is responsible for providing an appropriate ORB object as required by this specification.

16.14 TimerService References

The container must make the `TimerService` interface available either through injection using the `Resource` annotation or in JNDI under the name `java:comp/TimerService`, in addition to through the `EJBContext` interface. The `authenticationType` and `shareable` elements of the `Resource` annotation must not be specified.

A `TimerService` object reference may also be declared in a deployment descriptor in the same way as a resource environment reference. Such a deployment descriptor entry may be used to specify injection of a `TimerService` object.

16.14.1 Bean Provider's Responsibility

The Bean Provider is responsible for requesting injection of a `TimerService` object using a `Resource` annotation, or using the defined name to lookup the `TimerService` object.

16.14.2 Container Provider's Responsibility

The Container Provider is responsible for providing an appropriate `TimerService` object as required by this specification.

16.15 EJBContext References

The container must make a component's `EJBContext` interface available either through injection using the `Resource` annotation or in JNDI under the name `java:comp/EJBContext`. The `authenticationType` and `shareable` elements of the `Resource` annotation must not be specified.

An `EJBContext` object reference may also be declared in a deployment descriptor in the same way as a resource environment reference. Such a deployment descriptor entry may be used to specify injection of an `EJBContext` object.

16.15.1 Bean Provider's Responsibility

The Bean Provider is responsible for requesting injection of an `EJBContext` object using a `Resource` annotation or using the defined name to lookup the `EJBContext` object.

`EJBContext` objects accessed through the naming environment are only valid within the bean instance that performed the lookup.

16.15.2 Container Provider's Responsibility

The Container Provider is responsible for providing an appropriate `EJBContext` object to the referencing component. The object returned must be of the appropriate specific type for the bean requesting injection or performing the lookup—that is, the container provider must return an instance of the `SessionContext` interface to referencing session beans and an instance of the `MessageDrivenContext` interface to message-driven beans.

16.16 Deprecated EJBContext.getEnvironment Method

The *environment naming context* introduced in EJB 1.1 replaced the EJB 1.0 concept of *environment properties*.

An EJB 1.1 or later compliant container is not required to implement support for the EJB 1.0 style environment properties. If the container does not implement the functionality, it should throw a `RuntimeException` (or subclass thereof) from the `EJBContext.getEnvironment` method.

If an EJB 1.1 or later compliant container chooses to provide support for the EJB 1.0 style environment properties (so that it can support enterprise beans written to the EJB 1.0 specification), it should implement the support as described below.

When the tools convert the EJB 1.0 deployment descriptor to the EJB 1.1 XML format, they should place the definitions of the environment properties into the `ejb10-properties` subcontext of the environment naming context. The `env-entry` elements should be defined as follows: the `env-entry-name` element contains the name of the environment property, the `env-entry-type` must be `java.lang.String`, and the optional `env-entry-value` contains the environment property value.

For example, an EJB 1.0 enterprise bean with two environment properties `foo` and `bar`, should declare the following `env-entry` elements in its EJB 1.1 format deployment descriptor.

```
...
<env-entry>
  env-entry-name>ejb10-properties/foo</env-entry-name>
  <env-entry-type>java.lang.String</env-entry-type>
</env-entry>
<env-entry>
  <description>bar's description</description>
  <env-entry-name>ejb10-properties/bar</env-entry-name>
  <env-entry-type>java.lang.String</env-entry-type>
  <env-entry-value>bar value</env-entry-value>
</env-entry>
...
```

The container should provide the entries declared in the `ejb10-properties` subcontext to the instances as a `java.util.Properties` object that the instances obtain by invoking the `EJBContext.getEnvironment` method.

The enterprise bean uses the EJB 1.0 API to access the properties, as shown by the following example.

```
public class SomeBean implements SessionBean {
    SessionContext ctx;
    java.util.Properties env;

    public void setSessionContext(SessionContext sc) {
        ctx = sc;
        env = ctx.getEnvironment();
    }

    public someBusinessMethod(...) ... {
        String fooValue = env.getProperty("foo");
        String barValue = env.getProperty("bar");
    }
    ...
}
```

Security Management

This chapter defines the EJB architecture's support for security management.

17.1 Overview

We set the following goals for the security management in the EJB architecture:

- *Lessen the burden of the application developer (i.e. the Bean Provider) for securing the application by allowing greater coverage from more qualified EJB roles. The EJB Container Provider provides the implementation of the security infrastructure; the Deployer and System Administrator define the security policies.*
- *Allow the security policies to be set by the Application Assembler or Deployer.*
- *Allow the enterprise bean applications to be portable across multiple EJB servers that use different security mechanisms.*

The EJB architecture encourages the Bean Provider to implement the enterprise bean class without hard-coding the security policies and mechanisms into the business methods. In most cases, the enterprise bean's business methods should not contain any security-related logic. This allows the Deployer to configure the security policies for the application in a way that is most appropriate for the operational environment of the enterprise.

To make the Deployer's task easier, the Bean Provider or the Application Assembler (which could be the same party as the Bean Provider) may define *security roles* for an application composed of one or more enterprise beans. A security role is a semantic grouping of permissions that a given type of users of the application must have in order to successfully use the application. The Bean Provider can define declaratively using metadata annotations or the deployment descriptor the *method permissions* for each security role. The Applications Assembler can define, augment, or override the method permissions using the deployment descriptor. A method permission is a permission to invoke a specified group of methods of an enterprise bean's business interface, no-interface view, home interface, component interface, and/or web service endpoint. The security roles defined present a simplified security view of the enterprise beans application to the Deployer—the Deployer's view of the application's security requirements is the small set of security roles rather than a large number of individual methods.

The security principal under which a method invocation is performed is typically that of the component's caller. By specifying a run-as identity, however, it is possible to specify that a different principal be substituted for the execution of the methods of the bean's business interface, no-interface view, home interface, component interface, and/or web service endpoint and any methods of other enterprise beans that the bean may call.

This determines whether the caller principal is propagated from the caller to the callee—that is, whether the called enterprise bean will see the same returned value of the `EJBContext.getCallerPrincipal` as the calling enterprise bean—or whether a security principal that has been assigned to the specified security role will be used for the execution of the bean's methods and will be visible as the caller principal in the bean's callee.

The Bean Provider can use metadata annotations or the deployment descriptor to specify whether the caller's security identity or a run-as security identity should be used for the execution of the bean's methods.

- By default, the caller principal will be propagated as the caller identity. The Bean Provider can use the `RunAs` annotation to specify that a security principal that has been assigned to a specified security role be used instead. See Section 17.3.4.
- If the deployment descriptor is used to specify the security principal, the Bean Provider or the Application Assembler can use the `security-identity` deployment descriptor element to specify the security identity. If the `security-identity` deployment descriptor element is not specified and if a run-as identity has not been specified by the use of the `RunAs` annotation or if `use-caller-identity` is specified as the value of the `security-identity` element, the caller principal is propagated from the caller to the callee. If the `run-as` element is specified, a security principal that has been assigned to the specified security role will be used. The Application Assembler is permitted to override a security identity value set or defaulted by the Bean Provider.

The Deployer is responsible for assigning principals, or groups of principals, which are defined in the target operational environment, to the security roles defined by the Bean Provider or Application Assembler. The Deployer is also responsible for assigning principals for the run-as identities specified. The Deployer is further responsible for configuring other aspects of the security management of the enterprise beans, such as principal mapping for inter-enterprise bean calls, and principal mapping for resource manager access.

At runtime, a client will be allowed to invoke a business method only if the principal associated with the client call has been assigned by the Deployer to have at least one security role that is allowed to invoke the business method or if the Bean Provider or Application Assembler has specified that security authorization is not to be checked for the method (i.e., that all roles, including any unauthenticated roles, are permitted). See Section 17.3.2.

The Container Provider is responsible for enforcing the security policies at runtime, providing the tools for managing security at runtime, and providing the tools used by the Deployer to manage security during deployment.

Because not all security policies can be expressed declaratively, the EJB architecture provides a simple programmatic interface that the Bean Provider may use to access the security context from the business methods.

The following sections define the responsibilities of the individual EJB roles with respect to security management.

17.2 Bean Provider's Responsibilities

This section defines the Bean Provider's perspective of the EJB architecture support for security, and defines his or her responsibilities. In addition, the Bean Provider may define the security roles for the application, as defined in Section 17.3.

17.2.1 Invocation of Other Enterprise Beans

An enterprise bean business method can invoke another enterprise bean via the other bean's business interface or no-interface view or home or component interface. The EJB architecture provides no programmatic interfaces for the invoking enterprise bean to control the principal passed to the invoked enterprise bean.

The management of caller principals passed on *inter-enterprise* bean invocations (i.e. principal delegation) is set up by the Deployer and System Administrator in a container-specific way. The Bean Provider and Application Assembler should describe all the requirements for the caller's principal management of inter-enterprise bean invocations as part of the description.

17.2.2 Resource Access

Section 16.7 defines the protocol for accessing resource managers, including the requirements for security management.

17.2.3 Access of Underlying OS Resources

The EJB architecture does not define the operating system principal under which enterprise bean methods execute. Therefore, the Bean Provider cannot rely on a specific principal for accessing the underlying OS resources, such as files. (See Subsection 17.6.8 for the reasons behind this rule.)

We believe that most enterprise business applications store information in resource managers such as relational databases rather than in resources at the operating system levels. Therefore, this rule should not affect the portability of most enterprise beans.

17.2.4 Programming Style Recommendations

The Bean Provider should neither implement security mechanisms nor hard-code security policies in the enterprise beans' business methods. Rather, the Bean Provider should rely on the security mechanisms provided by the EJB container.

The Bean Provider can use metadata annotations and/or the deployment descriptor to convey security-related information to the Deployer. The information helps the Deployer to set up the appropriate security policy for the enterprise bean application.

17.2.5 Programmatic Access to Caller's Security Context

Note: In general, security management should be enforced by the container in a manner that is transparent to the enterprise beans' business methods. The security API described in this section should be used only in the less frequent situations in which the enterprise bean business methods need to access the security context information.

The `javax.ejb.EJBContext` interface provides two methods (plus two deprecated methods that were defined in EJB 1.0) that allow the Bean Provider to access security information about the enterprise bean's caller.

```
public interface javax.ejb.EJBContext {
    ...

    //
    // The following two methods allow the EJB class
    // to access security information.
    //
    java.security.Principal getCallerPrincipal();
    boolean isCallerInRole(String roleName);

    //
    // The following two EJB 1.0 methods are deprecated.
    //
    java.security.Identity getCallerIdentity();
    boolean isCallerInRole(java.security.Identity role);

    ...
}
```

The Bean Provider can invoke the `getCallerPrincipal` and `isCallerInRole` methods only in the enterprise bean's business methods as specified in Table 1 on page 94, Table 2 on page 103, Table 4 on page 149, Table 5 on page 231, and Table 11 on page 303. If they are otherwise invoked when no security context exists, they should throw the `java.lang.IllegalStateException` runtime exception.

The `getCallerIdentity()` and `isCallerInRole(Identity role)` methods were deprecated in EJB 1.1. The Bean Provider must use the `getCallerPrincipal()` and `isCallerInRole(String roleName)` methods for new enterprise beans.

An EJB 1.1 or later compliant container may choose to implement the two deprecated methods as follows.

- A container that does not want to provide support for this deprecated method should throw a `RuntimeException` (or subclass of `RuntimeException`) from the `getCallerIdentity` method.
- A container that wants to provide support for the `getCallerIdentity` method should return an instance of a subclass of the `java.security.Identity` abstract class from the method. The `getName` method invoked on the returned object must return the same value that `getCallerPrincipal().getName()` would return.
- A container that does not want to provide support for this deprecated method should throw a `RuntimeException` (or subclass of `RuntimeException`) from the `isCallerInRole(Identity identity)` method.
- A container that wants to implement the `isCallerInRole(Identity identity)` method should implement it as follows:

```
public isCallerInRole(Identity identity) {  
    return isCallerInRole(identity.getName());  
}
```

17.2.5.1 Use of `getCallerPrincipal`

The purpose of the `getCallerPrincipal` method is to allow the enterprise bean methods to obtain the current caller principal's name. The methods might, for example, use the name as a key to information in a database.

An enterprise bean can invoke the `getCallerPrincipal` method to obtain a `java.security.Principal` interface representing the current caller. The enterprise bean can then obtain the distinguished name of the caller principal using the `getName` method of the `java.security.Principal` interface. If the security identity has not been established, `getCallerPrincipal` returns the container's representation of the unauthenticated identity.

Note that `getCallerPrincipal` returns the principal that represents the caller of the enterprise bean, not the principal that corresponds to the run-as security identity for the bean, if any.

The meaning of the *current caller*, the Java class that implements the `java.security.Principal` interface, and the realm of the principals returned by the `getCallerPrincipal` method depend on the operational environment and the configuration of the application.

An enterprise may have a complex security infrastructure that includes multiple security domains. The security infrastructure may perform one or more mapping of principals on the path from an EJB caller to the EJB object. For example, an employee accessing his or her company over the Internet may be identified by a userid and password (basic authentication), and the security infrastructure may authenticate the principal and then map the principal to a Kerberos principal that is used on the enterprise's intranet before delivering the method invocation to the EJB object. If the security infrastructure performs principal mapping, the `getCallerPrincipal` method returns the principal that is the result of the mapping, not the original caller principal. (In the previous example, `getCallerPrincipal` would return the Kerberos principal.) The management of the security infrastructure, such as principal mapping, is performed by the System Administrator role; it is beyond the scope of the EJB specification.

The following code sample illustrates the use of the `getCallerPrincipal()` method.

```
@Stateless public class EmployeeServiceBean
    implements EmployeeService{
    @Resource SessionContext ctx;
    @PersistenceContext EntityManager em;

    public void changePhoneNumber(...) {
        ...

        // obtain the caller principal.
        callerPrincipal = ctx.getCallerPrincipal();

        // obtain the caller principal's name.
        callerKey = callerPrincipal.getName();

        // use callerKey as primary key to find EmployeeRecord
        EmployeeRecord myEmployeeRecord =
            em.find(EmployeeRecord.class, callerKey);

        // update phone number
        myEmployeeRecord.setPhoneNumber(...);

        ...
    }
}
```

In the previous example, the enterprise bean obtains the principal name of the current caller and uses it as the primary key to locate an `EmployeeRecord` entity. This example assumes that application has been deployed such that the current caller principal contains the primary key used for the identification of employees (e.g., employee number).

17.2.5.2 Use of `isCallerInRole`

The main purpose of the `isCallerInRole(String roleName)` method is to allow the Bean Provider to code the security checks that cannot be easily defined declaratively in the deployment descriptor using method permissions. Such a check might impose a role-based limit on a request, or it might depend on information stored in the database.

The enterprise bean code can use the `isCallerInRole` method to test whether the current caller has been assigned to a given security role. Security roles are defined by the Bean Provider or the Application Assembler (see Subsection 17.3.1), and are assigned to principals or principal groups that exist in the operational environment by the Deployer.

Note that `isCallerInRole(String roleName)` tests the principal that represents the caller of the enterprise bean, not the principal that corresponds to the run-as security identity for the bean, if any.

The following code sample illustrates the use of the `isCallerInRole(String roleName)` method.

```
@Stateless public class PayrollBean implements Payroll {
    @Resource SessionContext ctx;

    public void updateEmployeeInfo(EmplInfo info) {
        oldInfo = ... read from database;

        // The salary field can be changed only by callers
        // who have the security role "payroll"
        if (info.salary != oldInfo.salary &&
            !ctx.isCallerInRole("payroll")) {
            throw new SecurityException(...);
        }
        ...
    }
    ...
}
```

17.2.5.3 Declaration of Security Roles Referenced from the Bean's Code

The Bean Provider is responsible for using the `DeclareRoles` annotation or the `security-role-ref` elements of the deployment descriptor to declare all the security role names used in the enterprise bean code. The `DeclareRoles` annotation is specified on a bean class, where it serves to declare roles that may be tested by calling `isCallerInRole` from within the methods of the annotated class. Declaring the security roles allows the Bean Provider, Application Assembler, or Deployer to link these security role names used in the code to the security roles defined for an assembled application. In the absence of this linking step, any security role name as used in the code will be assumed to correspond to a security role of the same name.

The Bean Provider declares the security roles referenced in the code using the `DeclareRoles` meta-data annotation. When declaring the name of a role used as a parameter to the `isCallerInRole(String roleName)` method, the declared name must be the same as the parameter value. The Bean Provider may optionally provide a description of the named security roles in the `description` element of the `DeclareRoles` annotation.

In the following example, the `DeclareRoles` annotation is used to indicate that the enterprise bean `AardvarkPayroll` makes the security check using `isCallerInRole("payroll")` in its business method.

```
@DeclareRoles("payroll")
@Stateless public class PayrollBean implements Payroll {
    @Resource SessionContext ctx;

    public void updateEmployeeInfo(EmplInfo info) {
        oldInfo = ... read from database;

        // The salary field can be changed only by callers
        // who have the security role "payroll"
        if (info.salary != oldInfo.salary &&
            !ctx.isCallerInRole("payroll")) {
            throw new SecurityException(...);
        }
        ...
    }
    ...
}
```

If the `DeclareRoles` annotation is not used, the Bean Provider must use the `security-role-ref` elements of the deployment descriptor to declare the security roles referenced in the code. The `security-role-ref` elements are defined as follows:

- Declare the name of the security role using the `role-name` element. The name must be the security role name that is used as a parameter to the `isCallerInRole(String roleName)` method.
- Optionally provide a description of the security role in the `description` element.

The following example illustrates how an enterprise bean's references to security roles are declared in the deployment descriptor.

```
...
<enterprise-beans>
  ...
  <session>
    <ejb-name>AardvarkPayroll</ejb-name>
    <ejb-class>com.aardvark.payroll.PayrollBean</ejb-class>
    ...
    <security-role-ref>
      <description>
        This security role should be assigned to the
        employees of the payroll department who are
        allowed to update employees' salaries.
      </description>
      <role-name>payroll</role-name>
    </security-role-ref>
    ...
  </session>
  ...
</enterprise-beans>
...
```

The deployment descriptor above indicates that the enterprise bean `AardvarkPayroll` makes the security check using `isCallerInRole("payroll")` in its business method.

A security role reference, including the name defined by the reference, is scoped to the component whose bean class contains the `DeclareRoles` metadata annotation or whose deployment descriptor element contains the `security-role-ref` deployment descriptor element.

The Bean Provider (or Application Assembler) may also use the `security-role-ref` elements for those references that were declared in annotations and which the Bean Provider wishes to have linked to a `security-role` whose name differs from the reference value. If a security role reference is not linked to a security role in this way, the container must map the reference name to the security role of the same name. See section 17.3.3 for a description of how security role references are linked to security roles.

17.3 Responsibilities of the Bean Provider and/or Application Assembler

The Bean Provider and Application Assembler (which could be the same party as the Bean Provider) may define a *security view* of the enterprise beans contained in the `ejb-jar` file. Providing the security view is optional for the Bean Provider and Application Assembler.

The main reason for providing the security view of the enterprise beans is to simplify the Deployer's job. In the absence of a security view of an application, the Deployer needs detailed knowledge of the application in order to deploy the application securely. For example, the Deployer would have to know what each business method does to determine which users can call it. The security view defined by the Bean Provider or Application Assembler presents a more consolidated view to the Deployer, allowing the Deployer to be less familiar with the application.

The security view consists of a set of *security roles*. A security role is a semantic grouping of permissions that a given type of users of an application must have in order to successfully use the application.

The Bean Provider or Application Assembler defines *method permissions* for each security role. A method permission is a permission to invoke a specified group of methods of the enterprise beans' business interface, home interface, component interface, and/or web service endpoint.

It is important to keep in mind that the security roles are used to define the logical security view of an application. They should not be confused with the user groups, users, principals, and other concepts that exist in the target enterprise's operational environment.

In special cases, a qualified Deployer may change the definition of the security roles for an application, or completely ignore them and secure the application using a different mechanism that is specific to the operational environment.

17.3.1 Security Roles

The Bean Provider or Application Assembler can define one or more security roles in the bean's metadata annotations or deployment descriptor. The Bean Provider or Application Assembler then assigns groups of methods of the enterprise beans' business, home, and component interfaces, no-interface view, and/or web service endpoints to the security roles to define the security view of the application.

Because the Bean Provider and Application Assembler do not, in general, know the security environment of the operational environment, the security roles are meant to be *logical* roles (or actors), each representing a type of user that should have the same access rights to the application.

The Deployer then assigns user groups and/or user accounts defined in the operational environment to the security roles defined by the Bean Provider and Application Assembler.

Defining the security roles in the metadata annotations and/or deployment descriptor is optional^[91]. Their omission means that the Bean Provider and Application Assembler chose not to pass any security deployment related instructions to the Deployer.

If Java language metadata annotations are used, the Bean Provider uses the `DeclareRoles` and `RolesAllowed` annotations to define the security roles. The set of security roles used by the application is taken to be the aggregation of the security roles defined by the security role names used in the `DeclareRoles` and `RolesAllowed` annotations. The Bean Provider may augment the set of security roles defined for the application by annotations in this way by means of the `security-role` deployment descriptor element.

[91] If the Bean Provider and Application Assembler do not define security roles, the Deployer will have to define security roles at deployment time.

If the deployment descriptor is used, the The Bean Provider and/or Application Assembler uses the `security-role` deployment descriptor element as follows:

- Define each security role using a `security-role` element.
- Use the `role-name` element to define the name of the security role.
- Optionally, use the `description` element to provide a description of a security role.

The following example illustrates security roles definition in a deployment descriptor.

```
...
<assembly-descriptor>
  <security-role>
    <description>
      This role includes the employees of the
      enterprise who are allowed to access the
      employee self-service application. This role
      is allowed only to access his/her own
      information.
    </description>
    <role-name>employee</role-name>
  </security-role>

  <security-role>
    <description>
      This role includes the employees of the human
      resources department. The role is allowed to
      view and update all employee records.
    </description>
    <role-name>hr-department</role-name>
  </security-role>

  <security-role>
    <description>
      This role includes the employees of the payroll
      department. The role is allowed to view and
      update the payroll entry for any employee.
    </description>
    <role-name>payroll-department</role-name>
  </security-role>

  <security-role>
    <description>
      This role should be assigned to the personnel
      authorized to perform administrative functions
      for the employee self-service application.
      This role does not have direct access to
      sensitive employee and payroll information.
    </description>
    <role-name>admin</role-name>
  </security-role>
  ...
</assembly-descriptor>
```

17.3.2 Method Permissions

If the Bean Provider and/or Application Assembler have defined security roles for the enterprise beans in the ejb-jar file, they can also specify the methods of the business, home, and component interfaces, no-interface view, and/or web service endpoints that each security role is allowed to invoke.

Metadata annotations and/or the deployment descriptor can be used for this purpose.

Method permissions are defined as a binary relation from the set of security roles to the set of methods of the business interfaces, home interfaces, component interfaces, no-interface view, and/or web service endpoints of session and entity beans, including all their superinterfaces (including the methods of the `EJBHome` and `EJBObject` interfaces and/or `EJBLocalHome` and `EJBLocalObject` interfaces). The method permissions relation includes the pair (R, M) if and only if the security role R is allowed to invoke the method M .

17.3.2.1 Specification of Method Permissions with Metadata Annotations

The following is the description of the rules for the specification of method permissions using Java language metadata annotations.

The method permissions for the methods of a bean class may be specified on the class, the business methods of the class, or both.

The `RolesAllowed`, `PermitAll`, and `DenyAll` annotations are used to specify method permissions. The value of the `RolesAllowed` annotation is a list of security role names to be mapped to the security roles that are permitted to execute the specified method(s). The `PermitAll` annotation specifies that all security roles are permitted to execute the specified method(s). The `DenyAll` annotation specifies that no security roles are permitted to execute the specified method(s).

Specifying the `RolesAllowed` or `PermitAll` or `DenyAll` annotation on the bean class means that it applies to all applicable business methods of the class.

Method permissions may be specified on a method of the bean class to override the method permissions value specified on the bean class.

If the bean class has superclasses, the following additional rules apply.

- A method permissions value specified on a superclass S applies to the business methods defined by S .
- A method permissions value may be specified on a business method M defined by class S to override for method M the method permissions value explicitly or implicitly specified on the class S .
- If a method M of class S overrides a business method defined by a superclass of S , the method permissions value of M is determined by the above rules as applied to class S .

Example:

```
@RolesAllowed("admin")
public class SomeClass {
    public void aMethod () {...}
    public void bMethod () {...}
    ...
}

@Stateless public class MyBean extends SomeClass implements A {

    @RolesAllowed("HR")
    public void aMethod () {...}

    public void cMethod () {...}
    ...
}
```

Assuming `aMethod`, `bMethod`, `cMethod` are methods of business interface `A`, the method permissions values of methods `aMethod` and `bMethod` are `RolesAllowed("HR")` and `RolesAllowed("admin")` respectively. The method permissions for method `cMethod` have not been specified (see Sections 17.3.2.2 and 17.3.2.3).

17.3.2.2 Specification of Method Permissions in the Deployment Descriptor

The Bean Provider may use the deployment descriptor as an alternative to metadata annotations to specify the method permissions (or as a means to supplement or override metadata annotations for method permission values). The application assembler is permitted to override the method permission values using the bean's deployment descriptor.

Any values explicitly specified in the deployment descriptor override any values specified in annotations. If a value for a method has not been specified in the deployment descriptor, and a value has been specified for that method by means of the use of annotations, the value specified in annotations will apply. The granularity of overriding is on the per-method basis.

The Bean Provider or Application Assembler defines the method permissions relation in the deployment descriptor using the `method-permission` elements as follows.

- Each `method-permission` element includes a list of one or more security roles and a list of one or more methods. All the listed security roles are allowed to invoke all the listed methods. Each security role in the list is identified by the `role-name` element, and each method (or a set of methods, as described below) is identified by the `method` element. An optional description can be associated with a `method-permission` element using the `description` element.
- The method permissions relation is defined as the union of all the method permissions defined in the individual `method-permission` elements.
- A security role or a method may appear in multiple `method-permission` elements.

The Bean Provider or Application Assembler can indicate that all roles are permitted to execute one or more specified methods (i.e., the methods should not be “checked” for authorization prior to invocation by the container). The `unchecked` element is used instead of a role name in the `method-permission` element to indicate that all roles are permitted.

If the method permission relation specifies both the `unchecked` element for a given method and one or more security roles, all roles are permitted for the specified methods.

The `exclude-list` element can be used to indicate the set of methods that should not be called. The Deployer should configure the enterprise bean’s security such that no access is permitted to any method contained in the `exclude-list`.

If a given method is specified both in the `exclude-list` element and in the method permission relation, the Deployer should configure the enterprise bean’s security such that no access is permitted to the method.

The `method` element uses the `ejb-name`, `method-name`, and `method-params` elements to denote one or more methods of an enterprise bean’s business, home, and component interface, no-interface view, and/or web service endpoint. There are three legal styles for composing the `method` element:

Style 1:

```
<method>
  <ejb-name>EJBNAME</ejb-name>
  <method-name>*</method-name>
</method>
```

This style is used for referring to all of the methods of the business, home, and component interfaces, no-interface view, and web service endpoint of a specified enterprise bean.

Style 2:

```
<method>
  <ejb-name>EJBNAME</ejb-name>
  <method-name>METHOD</method-name>
</method>
```

This style is used for referring to a specified method of the business, home, or component interface, no-interface view, or web service endpoint of the specified enterprise bean. If there are multiple methods with the same overloaded name, this style refers to all of the overloaded methods.

Style 3:

```
<method>
  <ejb-name>EJBNAME</ejb-name>
  <method-name>METHOD</method-name>
  <method-params>
    <method-param>PARAMETER_1</method-param>
    ...
    <method-param>PARAMETER_N</method-param>
  </method-params>
```

</method>

This style is used to refer to a specified method within a set of methods with an overloaded name. The method must be defined in the specified enterprise bean's business, home, or component interface, no-interface view, or web service endpoint. If there are multiple methods with the same overloaded name, however, this style refers to all of the overloaded methods.

The optional `method-intf` element can be used to differentiate between methods with the same name and signature that are multiply defined across the business, component, or home interfaces, no-interface view, and/or web service endpoint. If the same method is a method of a local business interface, local component interface, or no-interface view, the same method permission values apply to the method for all of them. Likewise, if the same method is a method of both the remote business interface and remote component interface, the same method permission values apply to the method for both interfaces.

The following example illustrates how security roles are assigned method permissions in the deployment descriptor:

```

...
<method-permission>
  <role-name>employee</role-name>
  <method>
    <ejb-name>EmployeeService</ejb-name>
    <method-name>*</method-name>
  </method>
</method-permission>

<method-permission>
  <role-name>employee</role-name>
  <method>
    <ejb-name>AardvarkPayroll</ejb-name>
    <method-name>findByPrimaryKey</method-name>
  </method>
  <method>
    <ejb-name>AardvarkPayroll</ejb-name>
    <method-name>getEmployeeInfo</method-name>
  </method>
  <method>
    <ejb-name>AardvarkPayroll</ejb-name>
    <method-name>updateEmployeeInfo</method-name>
  </method>
</method-permission>

<method-permission>
  <role-name>payroll-department</role-name>
  <method>
    <ejb-name>AardvarkPayroll</ejb-name>
    <method-name>findByPrimaryKey</method-name>
  </method>
  <method>
    <ejb-name>AardvarkPayroll</ejb-name>
    <method-name>getEmployeeInfo</method-name>
  </method>
  <method>
    <ejb-name>AardvarkPayroll</ejb-name>
    <method-name>updateEmployeeInfo</method-name>
  </method>
  <method>
    <ejb-name>AardvarkPayroll</ejb-name>
    <method-name>updateSalary</method-name>
  </method>
</method-permission>

<method-permission>
  <role-name>admin</role-name>
  <method>
    <ejb-name>EmployeeServiceAdmin</ejb-name>
    <method-name>*</method-name>
  </method>
</method-permission>
...

```

17.3.2.3 Unspecified Method Permissions

It is possible that some methods are not assigned to any security roles nor annotated as `DenyAll` or contained in the `exclude-list` element. In this case, the Deployer should assign method permissions for all of the unspecified methods, either by assigning them to security roles, or by marking them as unchecked. If the Deployer does not assign method permissions to the unspecified methods, those methods must be treated by the container as unchecked.

17.3.3 Linking Security Role References to Security Roles

The security role references used in the components of the application are linked to the security roles defined for the application. In the absence of any explicit linking, a security role reference will be linked to a security role having the same name.

The Application Assembler may explicitly link all the security role references declared in the `DeclareRoles` annotation or `security-role-ref` elements for a component to the security roles defined by the use of annotations (see section 17.3.1) and/or in the `security-role` elements.

The Application Assembler links each security role reference to a security role using the `role-link` element. The value of the `role-link` element must be the name of one of the security roles defined in a `security-role` element or by means of the `DeclareRoles` annotations or `RolesAllowed` annotations (as described in section 17.3.1), but need not be specified when the `role-name` used in the code is the same as the name of the `security-role` (to be linked).

The following deployment descriptor example shows how to link the security role reference named `payroll` to the security role named `payroll-department`.

```

...
<enterprise-beans>
  ...
  <session>
    <ejb-name>AardvarkPayroll</ejb-name>
    <ejb-class>com.aardvark.payroll.PayrollBean</ejb-class>
    ...
    <security-role-ref>
      <description>
        This role should be assigned to the
        employees of the payroll department.
        Members of this role have access to
        anyone's payroll record.
        The role has been linked to the
        payroll-department role.
      </description>
      <role-name>payroll</role-name>
      <role-link>payroll-department</role-link>
    </security-role-ref>
    ...
  </session>
  ...
</enterprise-beans>
...

```

17.3.4 Specification of Security Identities in the Deployment Descriptor

The Bean Provider or Application Assembler typically specifies whether the caller's security identity should be used for the execution of the methods of an enterprise bean or whether a specific run-as identity should be used.

By default the caller's security identity is used. The Bean Provider can use the `RunAs` metadata annotation to specify a run-as identity for the execution of the bean's methods. If the deployment descriptor is used, the Bean Provider or the Application Assembler can use the `security-identity` deployment descriptor element for this purpose or to override a security identity specified in metadata. The value of the `security-identity` element is either `use-caller-identity` or `run-as`.

Defining the security identities in the deployment descriptor is optional for the Application Assembler. Their omission in the deployment descriptor means that the Application Assembler chose not to pass any instructions related to security identities to the Deployer in the deployment descriptor.

If a run-as security identity is not specified by the Deployer, the container should use the caller's security identity for the execution of the bean's methods.

17.3.4.1 Run-as

The Bean Provider can use the `RunAs` metadata annotation or the Bean Provider or Application Assembler can use the `run-as` deployment descriptor element to define a run-as identity for an enterprise bean in the deployment descriptor. The run-as identity applies to the enterprise bean as a whole, that is, to all methods of the enterprise bean's business, home, and component interfaces, no-interface view, and/or web service endpoint; to the message listener methods of a message-driven bean; and to the timeout callback methods of an enterprise bean; and all internal methods of the bean that they might in turn call.

Establishing a run-as identity for an enterprise bean does not affect the identities of its callers, which are the identities tested for permission to access the methods of the enterprise bean. The run-as identity establishes the identity the enterprise bean will use when it makes calls.

Because the Bean Provider and Application Assembler do not, in general, know the security environment of the operational environment, the run-as identity is designated by a *logical* role-name, which corresponds to one of the security roles defined by the Bean Provider or Application Assembler in the metadata annotations or deployment descriptor.

The Deployer then assigns a security principal defined in the operational environment to be used as the principal for the run-as identity. The security principal assigned by the Deployer should be a principal that has been assigned to the security role specified by `RunAs` annotation or by the `role-name` element of the `run-as` deployment descriptor element.

The Bean Provider and/or Application Assembler is responsible for the following in the specification of run-as identities:

- Use the `RunAs` metadata annotation or `role-name` element of the `run-as` deployment descriptor element to define the name of the security role.
- Optionally, use the `description` element to provide a description of the principal that is expected to be bound to the run-as identity in terms of its security role.

The following example illustrates the definition of a run-as identity using metadata annotations.

```
@RunAs("admin")
@Stateless public class EmployeeServiceBean
    implements EmployeeService{
    ...
}
```

Using the deployment descriptor, this can be specified as follows.

```
...
<enterprise-beans>
    ...
    <session>
        <ejb-name>EmployeeService</ejb-name>
        ...
        <security-identity>
            <run-as>
                <role-name>admin</role-name>
            </run-as>
        </security-identity>
        ...
    </session>
    ...
</enterprise-beans>
...
```

17.4 Deployer's Responsibilities

The Deployer is responsible for ensuring that an assembled application is secure after it has been deployed in the target operational environment. This section defines the Deployer's responsibility with respect to EJB security management.

The Deployer uses deployment tools provided by the EJB Container Provider to read the security view of the application supplied by the Bean Provider and/or Application Assembler in the metadata annotations and/or deployment descriptor. The Deployer's job is to map the security view that was specified by the Bean Provider and/or Application Assembler to the mechanisms and policies used by the security domain in the target operational environment. The output of the Deployer's work includes an application security policy descriptor that is specific to the operational environment. The format of this descriptor and the information stored in the descriptor are specific to the EJB container.

The following subsections describe the security related tasks performed by the Deployer.

17.4.1 Security Domain and Principal Realm Assignment

The Deployer is responsible for assigning the security domain and principal realm to an enterprise bean application.

Multiple principal realms within the same security domain may exist, for example, to separate the realms of employees, trading partners, and customers. Multiple security domains may exist, for example, in application hosting scenarios.

17.4.2 Assignment of Security Roles

The Deployer assigns principals and/or groups of principals (such as individual users or user groups) used for managing security in the operational environment to the security roles defined by means of the `DeclareRoles` and `RolesAllowed` metadata annotations and/or `security-role` elements of the deployment descriptor.

The Deployer does not assign principals and/or principal groups to the security role references—the principals and/or principals groups assigned to a security role apply also to all the linked security role references. For example, the Deployer of the `AardvarkPayroll` enterprise bean in subsection 17.3.3 would assign principals and/or principal groups to the security-role `payroll-department`, and the assigned principals and/or principal groups would be implicitly assigned also to the linked security role `payroll`.

The EJB architecture does not specify how an enterprise should implement its security architecture. Therefore, the process of assigning the logical security roles defined in the application's deployment descriptor to the operational environment's security concepts is specific to that operational environment. Typically, the deployment process consists of assigning to each security role one or more user groups (or individual users) defined in the operational environment. This assignment is done on a per-application basis. (That is, if multiple independent `ejb-jar` files use the same security role name, each may be assigned differently.) If the deployer does not assign the logical security roles defined by the application to groups in the operational environment, it must be assumed that a logical role maps to a principal or principal group of the same name.

17.4.3 Principal Delegation

The Deployer is responsible for configuring the principal delegation for inter-component calls. The Deployer must follow any instructions supplied by the Bean Provider and/or Application Assembler (for example, provided in the `RunAs` metadata annotations, the `run-as` elements of the deployment descriptor, in the `description` elements of the annotations or deployment descriptor, or in a deployment manual).

If the security identity is defaulted, or it is explicitly specified that the caller identity be used (e.g., `use-caller-identity` deployment descriptor element is specified), the caller principal is propagated from one component to another (i.e., the caller principal of the first enterprise bean in a call-chain is passed to the enterprise beans down the chain).

If the Bean Provider or Application Assembler specifies that a `run-as` identity be used on behalf of a particular enterprise bean, the Deployer must configure the enterprise beans such that the `run-as` principal is used as the caller principal on any calls that the enterprise bean makes to other beans, and that the `run-as` principal is propagated along the call-chain of those other beans (in the absence of the specification of any further `run-as` elements).

17.4.4 Security Management of Resource Access

The Deployer's responsibilities with respect to securing resource managers access are defined in subsection 16.7.2.

17.4.5 General Notes on Deployment Descriptor Processing

The Deployer can use the security view defined in the deployment descriptor by the Bean Provider and Application Assembler merely as “hints” and may change the information whenever necessary to adapt the security policy to the operational environment.

Since providing the security information is optional for the Bean Provider and Application Assembler, the Deployer is responsible for performing any tasks that have not been done by the Bean Provider or Application Assembler. (For example, if the definition of security roles and method permissions is missing in the metadata annotations and in deployment descriptor, the Deployer must define the security roles and method permissions for the application.) It is not required that the Deployer store the output of this activity in the standard ejb-jar file format.

17.5 EJB Client Responsibilities

This section defines the rules that the EJB client program must follow to ensure that the security context passed on the client calls, and possibly imported by the enterprise bean, do not conflict with the EJB server’s capabilities for association between a security context and transactions.

These rules are:

- A transactional client cannot change its principal association within a transaction. This rule ensures that all calls from the client within a transaction are performed with the same security context.
- A session bean’s client must not change its principal association for the duration of the communication with the session object. This rule ensures that the server can associate a security identity with the session instance at instance creation time, and never have to change the security association during the session instance lifetime.
- If transactional requests within a single transaction arrive from multiple clients (this could happen if there are intermediary objects or programs in the transaction call-chain), all requests within the same transaction must be associated with the same security context.

17.6 EJB Container Provider’s Responsibilities

This section describes the responsibilities of the EJB Container and Server Provider.

17.6.1 Deployment Tools

The EJB Container Provider is responsible for providing the deployment tools that the Deployer can use to perform the tasks defined in Section 17.4.

The deployment tools read the information from the beans' metadata annotations and/or deployment descriptor and present the information to the Deployer. The tools guide the Deployer through the deployment process, and present him or her with choices for mapping the security information in the metadata annotations and deployment descriptor to the security management mechanisms and policies used in the target operational environment.

The deployment tools' output is stored in an EJB container-specific manner, and is available at runtime to the EJB container.

17.6.2 Security Domain(s)

The EJB container provides a security domain and one or more principal realms to the enterprise beans. The EJB architecture does not specify how an EJB server should implement a security domain, and does not define the scope of a security domain.

A security domain can be implemented, managed, and administered by the EJB server. For example, the EJB server may store X509 certificates or it might use an external security provider such as Kerberos.

The EJB specification does not define the scope of the security domain. For example, the scope may be defined by the boundaries of the application, EJB server, operating system, network, or enterprise.

The EJB server can, but is not required to, provide support for multiple security domains, and/or multiple principal realms.

The case of multiple domains on the same EJB server can happen when a large server is used for application hosting. Each hosted application can have its own security domain to ensure security and management isolation between applications owned by multiple organizations.

17.6.3 Security Mechanisms

The EJB Container Provider must provide the security mechanisms necessary to enforce the security policies set by the Deployer. The EJB specification does not specify the exact mechanisms that must be implemented and supported by the EJB server.

The typical security functions provided by the EJB server include:

- *Authentication of principals.*
- *Access authorization for EJB calls and resource manager access.*
- *Secure communication with remote clients (privacy, integrity, etc.).*

17.6.4 Passing Principals on EJB Calls

The EJB Container Provider is responsible for providing the deployment tools that allow the Deployer to configure the principal delegation for calls from one enterprise bean to another. The EJB container is responsible for performing the principal delegation as specified by the Deployer.

The EJB container must be capable of allowing the Deployer to specify that, for all calls from a single application within a single Java EE product, the caller principal is propagated on calls from one enterprise bean to another (i.e., the multiple beans in the call chain will see the same return value from `getCallerPrincipal`).

This requirement is necessary for applications that need a consistent return value of `getCallerPrincipal` across a chain of calls between enterprise beans.

The EJB container must be capable of allowing the Deployer to specify that a run-as principal be used for the execution of the business, home, and component interfaces, no-interface view, and/or web service endpoint methods of a session or entity bean, or for the message listener methods of a message-driven bean.

17.6.5 Security Methods in javax.ejb.EJBContext

The EJB container must provide access to the caller's security context information from the enterprise beans' instances via the `getCallerPrincipal()` and `isCallerInRole(String roleName)` methods. The EJB container must provide the caller's security context information during the execution of a business method invoked via the enterprise bean's business, home, component, no-interface view, or message listener interface, web service endpoint, and/or `TimedObject` interface, as defined in Table 1 on page 94, Table 2 on page 103, Table 4 on page 149, Table 5 on page 231, and Table 11 on page 303. The container must ensure that all enterprise bean method invocations received through these interfaces are associated with some principal. If the security identity of the caller has not been established, the container returns the container's representation of the unauthenticated identity. The container must never return a null from the `getCallerPrincipal` method.

17.6.6 Secure Access to Resource Managers

The EJB Container Provider is responsible for providing secure access to resource managers as described in Subsection 16.7.3.

17.6.7 Principal Mapping

If the application requires that its clients are deployed in a different security domain, or if multiple applications deployed across multiple security domains need to interoperate, the EJB Container Provider is responsible for the mechanism and tools that allow mapping of principals. The tools are used by the System Administrator to configure the security for the application's environment.

17.6.8 System Principal

The EJB specification does not define the "system" principal under which the JVM running an enterprise bean's method executes.

Leaving the principal undefined makes it easier for the EJB container vendors to provide runtime support for EJB on top of their existing server infrastructures. For example, while one EJB container implementation can execute all instances of all enterprise beans in a single JVM, another implementation can use a separate JVM per `ejb-jar` per client. Some EJB containers may make the system principal the same as the application-level principal. Others may use different principals, potentially from different principal realms and even security domains.

17.6.9 Runtime Security Enforcement

The EJB container is responsible for enforcing the security policies defined by the Deployer. The implementation of the enforcement mechanism is EJB container implementation-specific. The EJB container may, but does not have to, use the Java programming language security as the enforcement mechanism.

For example, to isolate multiple executing enterprise bean instances, the EJB container can load the multiple instances into the same JVM and isolate them via using multiple class loaders, or it can load each instance into its own JVM and rely on the address space protection provided by the operating system.

The general security enforcement requirements for the EJB container follow:

- The EJB container must provide enforcement of the client access control per the policy defined by the Deployer. A caller is allowed to invoke a method if, and only if, the method is specified as `PermitAll` or the caller is assigned *at least one* of the security roles that includes the method in its method permissions definition. (That is, it is not meant that the caller must be assigned *all* the roles associated with the method.) If the container denies a client access to a business method, the container should throw the `javax.ejb.EJBAccessException`^[92]. If the EJB 2.1 client view is used, the container must throw the `java.rmi.RemoteException` (or its subclass, the `java.rmi.AccessException`) to the client if the client is a remote client, or the `javax.ejb.EJBException` (or its subclass, the `javax.ejb.AccessLocalException`) if the client is a local client.
- The EJB container must isolate an enterprise bean instance from other instances and other application components running on the server. The EJB container must ensure that other enterprise bean instances and other application components are allowed to access an enterprise bean only via the enterprise bean's business interface, component interface, home interface, no-interface view, and/or web service endpoint.
- The EJB container must isolate an enterprise bean instance at runtime such that the instance does not gain unauthorized access to privileged system information. Such information includes the internal implementation classes of the container, the various runtime state and context maintained by the container, object references of other enterprise bean instances, or resource managers used by other enterprise bean instances. The EJB container must ensure that the interactions between the enterprise beans and the container are only through the EJB architected views.
- The EJB container must ensure the security of the persistent state of the enterprise beans.
- The EJB container must manage the mapping of principals on calls to other enterprise beans or on access to resource managers according to the security policy defined by the Deployer.

[92] If the business interface is a remote business interface that extends `java.rmi.Remote`, the `java.rmi.AccessException` is thrown to the client instead.

- The container must allow the same enterprise bean to be deployed independently multiple times, each time with a different security policy^[93]. The container must allow multiple-deployed enterprise beans to co-exist at runtime.

17.6.10 Audit Trail

The EJB container may provide a security audit trail mechanism. A security audit trail mechanism typically logs all `java.security.Exceptions`. It also logs all denials of access to EJB servers, EJB container, EJB component interfaces, EJB home interfaces, EJB no-interface views, and EJB web service endpoints.

17.7 System Administrator's Responsibilities

This section defines the security-related responsibilities of the System Administrator. Note that some responsibilities may be carried out by the Deployer instead, or may require cooperation of the Deployer and the System Administrator.

17.7.1 Security Domain Administration

The System Administrator is responsible for the administration of principals. Security domain administration is beyond the scope of the EJB specification.

Typically, the System Administrator is responsible for creating a new user account, adding a user to a user group, removing a user from a user group, and removing or freezing a user account.

17.7.2 Principal Mapping

If the client is in a different security domain than the target enterprise bean, the System Administrator is responsible for mapping the principals used by the client to the principals defined for the enterprise bean. The result of the mapping is available to the Deployer.

The specification of principal mapping techniques is beyond the scope of the EJB architecture.

17.7.3 Audit Trail Review

If the EJB container provides an audit trail facility, the System Administrator is responsible for its management.

[93] For example, the enterprise bean may be installed each time using a different bean name (as specified by means of the deployment descriptor).

Timer Service

This chapter defines the EJB container-managed timer service. The EJB timer service is a container-provided service that allows the Bean Provider to register enterprise beans for timer callbacks to occur according to a calendar-based schedule, at a specified time, after a specified elapsed time, or at specified intervals.

18.1 Overview

Enterprise applications that model workflow-type business processes are dependent on notifications that certain temporal events have occurred in order to manage the semantic state transitions that are intrinsic to the business processes that they model.

The EJB Timer Service is a container-managed service that allows callbacks to be scheduled for time-based events. The container provides a reliable and transactional notification service for timed events. Timer notifications may be scheduled to occur according to a calendar-based schedule, at a specific time, after a specific elapsed duration, or at specific recurring intervals.

The Timer Service is implemented by the EJB container. An enterprise bean accesses this service by means of dependency injection, through the `EJBContext` interface, or through lookup in the JNDI namespace.

The EJB Timer Service is a coarse-grained timer notification service that is designed for use in the modeling of application-level processes. It is not intended for the modeling of real-time events.

While timer durations are expressed in millisecond units, this is because the millisecond is the unit of time granularity used by the APIs of the Java SE platform. It is expected that most timed events will correspond to hours, days, or longer periods of time.

The following sections describe the Timer Service with respect to the various individual EJB roles.

18.2 Bean Provider's View of the Timer Service

The EJB Timer Service is a container-provided service that allows enterprise beans to be registered for timer callback methods to occur according to a calendar-based schedule, at a specified time, after a specified elapsed time, or after specified intervals. The timer service provides methods for the programmatic creation and cancellation of timers, as well as for locating the timers that are associated with a bean. Timers can also be created automatically by the container at deployment time based on metadata in the bean class or in the deployment descriptor.

A timer is created to schedule timed callbacks. The bean class of an enterprise bean that uses the timer service must provide one or more timeout callback methods. For programmatically created timers, this method may be a method that is annotated with the `Timeout` annotation, or the bean may implement the `javax.ejb.TimedObject` interface. The `javax.ejb.TimedObject` interface has a single method, the timer callback method `ejbTimeout`.

For automatically created timers, the timeout method may be a method that is annotated with the `Schedule` annotation. Timers can be created for stateless session beans, singleton session beans, message-driven beans, and 2.1 entity beans^[94]. Timers cannot be created for stateful session beans^[95].

A timer that is created for a 2.1 entity bean is associated with the entity bean's identity. The timeout callback method invocation for a timer that is created for a stateless session bean or a message-driven bean may be called on any bean instance in the pooled state.

When the time specified at timer creation elapses, the container invokes the associated timeout callback method of the bean. A timer may be cancelled by a bean before its expiration. If a timer is cancelled, its associated timeout callback method is not called^[96]. A timer is cancelled by calling its `cancel` method.

Invocations of the methods to create and cancel timers and of a timeout callback method are typically made within a transaction.

[94] The calendar-based timer and non-persistent timer functionality is not supported for 2.1 Entity beans.

[95] This functionality may be added in a future release of this specification.

[96] In the event of race conditions, extraneous calls to the timeout callback method may occur.

The timer service is intended for the modelling of long-lived business processes. Timers survive container crashes, server shutdown, and the activation/passivation and load/store cycles of the enterprise beans that are registered with them. These persistent guarantees can optionally be disabled on a per-timer basis.

18.2.1 Calendar-Based Time Expressions

The Timer Service allows a timer callback schedule to be expressed using a calendar-based syntax that is modeled after the UNIX cron facility. Calendar-based expressions can be used for programmatic timer creation or for automatic timer creation (via metadata or the deployment descriptor). Each of these approaches for expressing the calendar-based schedule shares common syntax and defaults.

Calendar based timers are not supported for EJB 2.x entity beans.

There are seven attributes in a calendar-based time expression :

- ***second*** : one or more seconds within a minute

Allowable values : [0,59]

- ***minute*** : one or more minutes within an hour

Allowable values : [0,59]

- ***hour*** : one or more hours within a day

Allowable values : [0,23]

- ***dayOfMonth*** : one or more days within a month

Allowable values :

[1,31] or

[-7, -1] or

“Last” or

{“1st”, “2nd”, “3rd”, “4th”, “5th”, “Last”} {“Sun”, “Mon”, “Tue”, “Wed”, “Thu”, “Fri”, “Sat”}

“Last” means the last day of the month

-x (where x is in the range [-7, -1]) means x day(s) before the last day of the month

“1st”, “2nd”, etc. applied to a day of the week identifies a single occurrence of that day within the month.

- ***month*** : one or more months within a year

Allowable values :

[1,12]

or

{"Jan", "Feb", "Mar", "Apr", "May", "Jun", "Jul", "Aug", "Sep", "Oct", "Nov", "Dec"}

- *dayOfWeek* : one or more days within a week

Allowable values :

[0,7] or

{"Sun", "Mon", "Tue", "Wed", "Thu", "Fri", "Sat"}

"0" and "7" both refer to Sunday

- *year* : a particular calendar year

Allowable values : a four-digit calendar year

18.2.1.1 Attribute Syntax

Each attribute supports values expressed in one of the following forms :

18.2.1.1.1 Single Value

Constrains the attribute to only one of its possible values.

Example: `second = "10"`

Example: `month= "Sep"`

18.2.1.1.2 Wild Card

"*" represents all possible values for a given attribute.

Example: `second = "*"`

Example: `dayOfWeek = "*"`

18.2.1.1.3 List

Constrains the attribute to two or more allowable values or ranges, with a comma used as a separator character. Each item in the list must be an individual attribute value or a range. List items can not themselves be lists, wild-cards, or increments. Duplicate values are allowed, but are ignored.

Example: `second = "10,20,30"`

Example: `dayOfWeek = "Mon,Wed,Fri"`

Example: `minute = "0-10,30,40"`

18.2.1.1.4 Range

Constrains the attribute to an *inclusive* range of values, with a dash separating both ends of the range. Each side of the range must be an individual attribute value. Members of a range can not themselves be lists, wild-cards, ranges, or increments. In range "*x-y*", if *x* is larger than *y*, the range is equivalent to "*x-max, min-y*", where *max* is the largest value of the corresponding attribute and *min* is the smallest. The range "*x-x*", where both range values are the same, evaluates to the single value *x*. The `dayOfWeek` range "`0-7`" is equivalent to `"*"`.

Example: `second="1-10"`

Example: `dayOfWeek = "Fri-Mon"`

Example: `dayOfMonth = "27-3"` (Equivalent to `"27-Last , 1-3"`)

18.2.1.1.5 Increments

The forward slash constrains an attribute based on a starting point and an interval, and is used to specify "Every *N* { seconds | minutes | hours } within the { minute | hour | day }" (respectively). For expression *x/y*, the attribute is constrained to every *y*th value within the set of allowable values beginning at time *x*. The *x* value is inclusive. The wildcard character (*) can be used in the *x* position, and is equivalent to 0. Increments are only supported within the `second`, `minute`, and `hour` attributes. For `second` and `minute`, *x* and *y* must each be in the range of [0, 59]. For `hour`, *x* and *y* must each be in the range of [0, 23].

Example: `minute = "*/5"` (Every five minutes within the hour)

This is equivalent to: `minute = "0,5,10,15,20,25,30,35,40,45,50,55"`

Example: `second = "30/10"` (Every 10 seconds within the minute, starting at second 30)

This is equivalent to: `second = "30,40,50"`

Note that the set of matching increment values stops once the maximum value for that attribute is exceeded. It does not "roll over" past the boundary.

Example : (`minute = "*/14"`, `hour="1,2"`) (Every 14 minutes within the hour, for the hours of 1 and 2 a.m.)

This is equivalent to: (`minute = "0,14,28,42,56"`, `hour = "1,2"`)

18.2.1.1.6 Time Zone Support

Schedule-based timer times are evaluated in the context of the default time zone associated with the container in which the application is executing. A schedule-based timer may optionally override this default and associate itself with a specific time zone. If the schedule-based timer is associated with a specific time zone, all its times are evaluated in the context of that time zone, regardless of the default time zone in which the container is executing.

Time zones are specified as an ID String^[97]. The set of required time zone IDs is defined by the Zone Name(TZ) column of the public domain zoneinfo database [36].

18.2.1.2 Expression Rules

The `second`, `minute`, and `hour` attributes have a default value of "0".

The `dayOfMonth`, `month`, `dayOfWeek`, and `year` attributes have a default value of "*".

If `dayOfMonth` has a non-wildcard value and `dayOfWeek` has a non-wildcard value, then either the `dayOfMonth` field *or* the `dayOfWeek` field must match the current day (even though the other of the two fields need not match the current day).

Whitespace is ignored, except for string constants and numeric values.

All string constants ("Sun", "Jan", "1st" etc.) are case *insensitive*.

Duplicate values within `List` attributes are ignored.

Increments are only supported within the `second`, `minute`, and `hour` attributes.

18.2.1.3 Examples

18.2.1.3.1 "Every Monday at Midnight"

```
@Schedule (dayOfWeek="Mon")
```

Note that this is equivalent to the following fully-qualified expression :

```
@Schedule (second="0", minute="0", hour="0", dayOfMonth="*",
month="*", dayOfWeek="Mon", year="*")
```

[97] Note that annotation `java.lang.String` attributes use the empty string "" as a default, so the expression `@Schedule (time-zone="", ...)` will result in a null value from the corresponding `ScheduleExpression.getTimezone()` method.

18.2.1.3.2 “Every Weekday morning at 3:15”

```
@Schedule(minute="15", hour="3", dayOfWeek="Mon-Fri")
```

18.2.1.3.3 “Every morning at 3:15 U.S. Eastern Time”

```
@Schedule(minute="15", hour="3", timezone="America/New_York")
```

18.2.1.3.4 “Every minute of every hour of every day”

```
@Schedule(minute="*", hour="*")
```

18.2.1.3.5 “Every Monday, Wednesday, and Friday at 30 seconds past noon”

```
@Schedule(second="30", hour="12", dayOfWeek="Mon,Wed,Fri")
```

18.2.1.3.6 “Every five minutes within the hour”

```
@Schedule(minute="*/5", hour="*")
```

Note that this is equivalent to the following expression :

```
@Schedule(minute="0,5,10,15,20,25,30,35,40,45,50,55", hour="*")
```

18.2.1.3.7 “The last Thursday in November at 2 p.m.”

```
@Schedule(hour="14", dayOfMonth="Last Thu", month="Nov")
```

18.2.1.3.8 “The second to last day (one day before the last day) of each month at 1 a.m.”

```
@Schedule(hour="1", dayOfMonth="-1")
```

18.2.1.3.9 “Every other hour within the day starting at noon on the 2nd Tuesday of every month.”

```
@Schedule(hour="12/2", dayOfMonth="2nd Tue")
```

18.2.2 Automatic Timer Creation

The Timer Service supports the automatic creation of a timer based on metadata in the bean class or deployment descriptor. This allows the bean developer to schedule a timer without relying on a bean invocation to programmatically invoke one of the Timer Service timer creation methods. Automatically created timers are created by the container as a result of application deployment.

The `Schedule` annotation can be used to automatically create a timer with a particular timeout schedule. This annotation is applied to a method of a bean class (or super-class) that should receive the timer callbacks associated with that schedule.

Example :

```
// Generate account statements at 1 a.m. on the 1st of every month
@Schedule(hour="1", dayOfMonth="1")
public void generateMonthlyAccountStatements() { ... }
```

Multiple automatic timers can be applied to a single timeout callback method using the `Schedules` annotation.

Example :

```
@Schedules(
{   @Schedule(hour="12", dayOfWeek="Mon-Thu"),
    @Schedule(hour="11", dayOfWeek="Fri")
})
public void sendLunchNotification() { ... }
```

A `@Schedule` annotation can optionally specify an `info` string. This string is retrieved by calling `Timer.getInfo()` on the associated `Timer` object. If no `info` string is specified, the `getInfo()` method for a timer created via `@Schedule` returns `null`.^[98]

Example :

```
// Generate account statements at 1 a.m. on the 1st of every month
@Schedule(hour="1", dayOfMonth="1", info="AccountStatementTimer")

public void generateMonthlyAccountStatements(Timer t) {
    String timerInfo = t.getInfo();
    ...
}
```

[98] Note that annotation `java.lang.String` attributes use the empty string `""` as a default, so the expression `@Schedule(info="", ...)` will also result in a null value from the timer's `getInfo()` method.

By default, each `Schedule` annotation corresponds to a single persistent timer, regardless of the number of JVMs across which the container is distributed.

18.2.3 Non-persistent Timers

A non-persistent timer is a timer whose lifetime is tied to the JVM in which it is created. A non-persistent timer is considered cancelled in the event of application shutdown, container crash, or a failure/shutdown of the JVM on which the timer was started.

Non-persistent timers are not supported for EJB 2.x Entity Beans.

Non-persistent timers can be created programmatically or automatically (using `@Schedule` or the deployment descriptor). For automatic non-persistent timers, the container creates a *new* non-persistent timer during application initialization for *each* JVM across which the container is distributed.

Automatic non-persistent timers can be specified by setting the `persistent` attribute of the `@Schedule` annotation to `false`.

Example :

```
@Singleton
public class CacheBean {

    Cache cache;

    // Setup an automatic timer to refresh
    // the Singleton instance cache every 10 minutes
    @Schedule(minute="*/10", hour="*", persistent=false)
    public void refresh() {
        // ...
    }
}
```

18.2.4 The Timer Service Interface

The Timer Service is accessed via dependency injection, through the `getTimerService` method of the `EJBContext` interface, or through lookup in the JNDI namespace. The `TimerService` interface has the following methods:

```
public interface javax.ejb.TimerService {

    public Timer createTimer(long duration,
        java.io.Serializable info);

    public Timer createTimer(java.util.Date expiration,
        java.io.Serializable info);

    public Timer createSingleActionTimer(long duration,
        TimerConfig timerConfig);

    public Timer createSingleActionTimer(java.util.Date expiration,
        TimerConfig timerConfig);

    public Timer createTimer(long initialDuration,
        long intervalDuration, java.io.Serializable info);

    public Timer createTimer(java.util.Date initialExpiration,
        long intervalDuration, java.io.Serializable info);

    public Timer createIntervalTimer(long initialDuration,
        long intervalDuration, TimerConfig timerConfig);

    public Timer createIntervalTimer(java.util.Date initialExpiration,
        long intervalDuration, TimerConfig timerConfig);

    public Timer createCalendarTimer(ScheduleExpression schedule);

    public Timer createCalendarTimer(ScheduleExpression schedule,
        TimerConfig timerConfig);

    public Collection<Timer> getTimers();

}
```

The timer creation methods allow a timer to be programmatically created as a single-event timer, as an interval timer, or as a calendar schedule based timer.

For single-event timers and interval timers, the timer expiration (initial expiration in the case of an interval timer) may be expressed either in terms of a duration or as an absolute time. The timer duration is expressed in terms of milliseconds. The timer service begins counting down the timer duration upon timer creation.

For calendar schedule based timers, the schedule is expressed by a `ScheduleExpression` helper object passed as a parameter to a `createCalendarTimer` method. `ScheduleExpression` represents a calendar based timer expression conforming to the requirements in Section 18.2.1. A `ScheduleExpression` has additional methods that further constrain the schedule based on an optional start date and/or end date.

The bean may pass some client-specific information at timer creation to help it recognize the significance of the timer's expiration. This information is stored by the timer service and available through the timer. The information object must be serializable. ^[99]

By default, all timers created using the timer creation methods are persistent. A non-persistent timer can be created by calling `setPersistent(false)` on a `TimerConfig` object passed to a timer creation method. `TimerConfig` also supports the setting of an `info` object.

The timer creation methods return a `Timer` object that allows the bean to cancel the timer or to obtain information about the timer prior to its cancellation and/or expiration.

The `getTimers` method returns the active timers associated with the bean. For an EJB 2.1 entity bean, the result of `getTimers` is a collection of those timers that are associated with the bean's identity.

18.2.4.1 Example

This code programmatically creates a timer that expires every Saturday at 1 a.m.

```
ScheduleExpression schedule =
    new ScheduleExpression().dayOfWeek("Sat").hour(1);
Timer timer = timerService.createCalendarTimer(schedule);
```

18.2.5 Timeout Callbacks

The enterprise bean class of a bean that is to be registered with the timer service for timer callbacks must provide one or more timeout callback methods.

There are two kinds of timeout callback methods :

- timeout callback methods for timers that are programmatically created via a `TimerService` timer creation method.
- timeout callback methods for timers that are automatically created via the `Schedule` annotation or the deployment descriptor

[99] There is currently no way to set the information object after timer creation. An API to do this may be added in a future release of this specification.

18.2.5.1 Timeout Callbacks for Programmatic Timers

All timers created via one of the `TimerService` timer creation methods for a particular component use a single timeout callback method. This method may be a method annotated with the `Timeout` annotation (or a method specified as a timeout method in the deployment descriptor) or the bean may implement the `javax.ejb.TimedObject` interface. This interface has a single method, `ejbTimeout`. If the bean implements the `TimedObject` interface, the `Timeout` annotation or `timeout-method` deployment descriptor element can only be used to specify the `ejbTimeout` method. A bean can have at most one timeout method for handling programmatic timers.^[100]

```
public interface javax.ejb.TimedObject {
    public void ejbTimeout(Timer timer);
}
```

18.2.5.2 Timeout Callbacks for Automatically Created Timers

Each automatically created timer is associated with a single timeout callback method. Each timeout method is declared using either the `Schedule` / `Schedules` annotation or the deployment descriptor. A timed object can have any number of automatically created timers.

18.2.5.3 Timeout Callback Method Requirements

A timeout callback method must have one of the two signatures below, where `<METHOD>` designates the method name^[101].

```
void <METHOD>()
```

```
void <METHOD>(Timer timer)[102]
```

A timeout callback method can have public, private, protected, or package level access. A timeout callback method must not be declared as `final` or `static`.

Timeout callback methods must not throw application exceptions.

[100] This method may be specified on the bean class or on a superclass. If the `Timeout` annotation is used or the bean implements the `TimedObject` interface, the `timeout-method` deployment descriptor element, if specified, can only be used to refer to the same method.

[101] If the bean implements the `TimedObject` interface, the `Timeout` annotation may optionally be applied to the `ejbTimeout` method.

[102] An earlier version of the specification required that timeout callbacks accept the `Timer` parameter but did not require that this parameter be listed when declared via `.xml`. To preserve backward compatibility, a `<timeout-method>` that does not include a `<method-param>` element for the `javax.ejb.Timer` parameter may be used to match either a timeout method signature with or without a `Timer` parameter. If a timer methods are overloaded, a `<timeout-method>` with an empty `<method-params>` element may be used to explicitly refer to a the no-arg timeout method.

When the timer expires (i.e., after one of its scheduled times arrives or after the absolute time specified has passed), the container calls the associated timeout method of the bean that was registered for the timer. The timeout method contains the business logic that the Bean Provider supplies to handle the timeout event. The container calls the timeout method with the timer that has expired. The Bean Provider can use the `getInfo` method to retrieve the information that was supplied when the timer was created. This information may be useful in enabling the timed object to recognize the significance of the timer expiration.

The container interleaves calls to a timeout callback method with the calls to the business methods and the life cycle callback methods of the bean. The time at which a timeout callback method is called may therefore not correspond exactly to the time specified at timer creation. If multiple timers have been created for a bean and will expire at approximately the same times, the Bean Provider must be prepared to handle timeout callbacks that are out of sequence. The Bean Provider must be prepared to handle extraneous calls to a timeout callback method in the event that a timer expiration is outstanding when a call to the cancellation method has been made.

In general, a timeout callback method can perform the same operations as business methods from the component interface or methods from the message listener interface. See Tables 2, 4, 5, and 11 for the specification of the operations that may be performed by a timeout callback method.

Since a timeout callback method is an internal method of the bean class, it has no client security context. When `getCallerPrincipal` is called from within a timeout callback method, it returns the container's representation of the unauthenticated identity.

If the timed object needs to make use of the identity of the timer to recognize the significance of the timer expiration, it may use the `equals` method to compare it with any other timer references it might have outstanding.

If the timer is a single-action timer, the container removes the timer after the timeout callback method has been successfully invoked (e.g., when the transaction that has been started for the invocation of the timeout callback method commits). If the bean invokes a method on the timer after the termination of the timeout callback method, a `NoSuchObjectLocalException` must be thrown.

If the timer is a calendar-based timer, the container removes the timer after the timeout callback method has been successfully invoked (e.g., when the transaction that has been started for the invocation of the timeout callback method commits) and there are no future timeouts corresponding to the timer's calendar expression. If the bean invokes a method on the timer after it has been removed, a `NoSuchObjectLocalException` must be thrown. If the bean invokes the `getNextTimeout` or `getTimeRemaining` method on the timer associated with a timeout callback while *within* the timeout callback, and there are no future timeouts for this calendar-based timer, a `NoMoreTimeoutsException` must be thrown.

18.2.6 The Timer and TimerHandle Interfaces

The `javax.ejb.Timer` interface allows the Bean Provider to cancel a timer and to obtain information about the timer.

The `javax.ejb.TimerHandle` interface allows the Bean Provider to obtain a serializable timer handle that may be persisted. Timer handles are only available for persistent timers. Since timers are local objects, a `TimerHandle` must not be passed through a bean's remote business interface, remote interface or web service interface.

The methods of these interfaces are as follows:

```
public interface javax.ejb.Timer {
    public void cancel();
    public long getTimeRemaining();
    public java.util.Date getNextTimeout();
    public javax.ejb.ScheduleExpression getSchedule();
    public javax.ejb.TimerHandle getHandle();
    public java.io.Serializable getInfo();
    public boolean isPersistent();
    public boolean isCalendarTimer();
}

public interface javax.ejb.TimerHandle extends java.io.Serializable {
    public javax.ejb.Timer getTimer();
}
```

18.2.7 Timer Identity

The Bean Provider cannot rely on the `==` operator to compare timers for “object equality”. The Bean Provider must use the `Timer.equals(Object obj)` method.

18.2.8 Transactions

An enterprise bean typically creates a timer within the scope of a transaction. If the transaction is then rolled back, the timer creation is rolled back.

An enterprise bean typically cancels a timer within a transaction. If the transaction is rolled back, the container rescinds the timer cancellation.

A timeout callback method on a bean with container-managed transactions has transaction attribute `REQUIRED` or `REQUIRES_NEW` (`Required` or `RequiresNew` if the deployment descriptor is used to specify the transaction attribute) . If the container-managed transaction is rolled back, the container retries the timeout.

Note that the container must start a new transaction if the `REQUIRED` (Required) transaction attribute is used. This transaction attribute value is allowed so that specification of a transaction attribute for the timeout callback method can be defaulted.

The transaction semantics described in this section apply to both persistent and non-persistent timers.

18.3 Bean Provider's Responsibilities

This section defines the Bean Provider's responsibilities.

18.3.1 Enterprise Bean Class

An enterprise bean that is to be registered with the Timer Service must have a timeout callback method. The enterprise bean class may have superclasses and/or superinterfaces. If the bean class has superclasses, the timeout method may be defined in the bean class, or in any of its superclasses.

18.3.2 TimerHandle

Since the `TimerHandle` interface extends `java.io.Serializable`, a client may serialize the handle. The serialized handle may be used later to obtain a reference to the timer identified by the handle. A `TimerHandle` is intended to be storable in persistent storage.

A `TimerHandle` must not be passed as an argument or result of an enterprise bean's remote business interface, remote interface, or web service method.

18.4 Container's Responsibilities

This section describes the responsibilities of the Container Provider to support the EJB Timer Service.

18.4.1 TimerService, Timer, and TimerHandle Interfaces

The container must provide the implementation of the `TimerService`, `Timer`, and `TimerHandle` interfaces.

Timer instances must not be serializable.

The container must implement a timer handle to be usable over the lifetime of the timer.

The container must provide suitable implementations of the `Timer equals(Object obj)` and `hashCode()` methods.

18.4.2 Automatic Timers

The container must create a timer for each automatic timer specified via a `Schedule` annotation, `Schedules` annotation, or in the deployment descriptor.

18.4.3 Timer Expiration and Timeout Callback Method

The container must call the timeout callback method after the timed duration or the absolute time specification in the timer creation method has passed. The container must also call a timeout callback method if a time matching the timer's schedule expression has been reached. The timer service must begin to count down the timer duration upon timer creation. The container must call the timeout callback method with the expired `Timer`, unless it's a no-arg timeout callback method for an automatically created timer.

If container-managed transaction demarcation is used and the `REQUIRED` or `REQUIRES_NEW` transaction attribute is specified or defaulted (`Required` or `RequiresNew` if the deployment descriptor is used), the container must begin a new transaction prior to invoking the timeout callback method. If the transaction fails or is rolled back, the container must retry the timeout at least once.

If a timer for an EJB 2.1 entity bean expires, and the bean has been passivated, the container must call the `ejbActivate` and `ejbLoad` methods on the entity bean class before calling the timeout callback method, as described in Sections 8.5.3 and 10.1.4.2.

If the timer is a single-event timer, the container must cause the timer to no longer exist. If a `javax.ejb.Timer` interface method is subsequently invoked on the timer after the completion of the timeout callback method, the container must throw the `javax.ejb.NoSuchObjectLocalException`.

If the Bean Provider invokes the `setRollbackOnly` method from within the timeout callback method, the container must rollback the transaction in which the timeout callback method is invoked. This has the effect of rescinding the timer expiration. The container must retry the timeout after the transaction rollback.

Timers are persistent objects (unless explicitly created as non-persistent timers). In the event of a container crash or container shutdown, any single-event persistent timers that have expired during the intervening time before container restart must cause the corresponding timeout callback method to be invoked upon restart. Any interval persistent timers or schedule based persistent timers that have expired during the intervening time must cause the corresponding timeout callback method to be invoked at least once upon restart.

18.4.4 Timer Cancellation

When a timer's `cancel` method has been called, the container must cause the timer to no longer exist. If a `javax.ejb.Timer` method is subsequently invoked on the timer, the container must throw the `javax.ejb.NoSuchObjectLocalException`.

When the `cancel` method of an automatically created non-persistent timer has been called, the container only causes the timer in the currently running JVM to no longer exist. The container does *not* nullify the rule that creates a new non-persistent timer upon application startup.

If the transaction in which the timer cancellation occurs is rolled back, the container must restore the duration of the timer to the duration it would have had if it had not been cancelled. If the timer would have expired by the time that the transaction failed, the failure of the transaction should result in the expired timer providing an expiration notification after the transaction rolls back.

18.4.5 Entity Bean Removal

If an entity bean is removed, the container must remove the timers for that bean.

Deployment Descriptor

This chapter defines the EJB deployment descriptor. Section 19.1 provides an overview of the deployment descriptor. Sections 19.2 through 19.4 describe the information in the deployment descriptor from the perspective of the EJB roles responsible for providing the information. Section 19.5 defines the deployment descriptor's XML Schema elements that are specific to the EJB architecture. The XML Schema elements that are common to the Java EE Platform specifications are provided in [12].

19.1 Overview

The deployment descriptor is part of the contract between the `ejb-jar/.war` file producer and consumer. This contract covers both the passing of enterprise beans from the Bean Provider to the Application Assembler, and from the Application Assembler to the Deployer.

An `ejb-jar/.war` file produced by the Bean Provider contains one or more enterprise beans and typically does not contain application assembly instructions. An `ejb-jar/.war` file produced by an Application Assembler contains one or more enterprise beans, plus application assembly information describing how the enterprise beans are combined into a single application deployment unit.

The Java EE specification defines how enterprise beans and other application components contained in multiple `ejb-jar` files can be assembled into an application.

The role of the deployment descriptor is to capture declarative information that is not included directly in the enterprise beans' code and that is intended for the consumer of the `ejb-jar/.war` file.

There are two basic kinds of information in the deployment descriptor:

- *Enterprise beans' structural information.* Structural information describes the structure of an enterprise bean and declares an enterprise bean's external dependencies. Providing structural information for the `ejb-jar/.war` file producer. Structural information may be provided using metadata annotations in the beans' code or in the deployment descriptor. The structural information cannot, in general, be changed because doing so could break the enterprise bean's function.
- *Application assembly information.* Application assembly information describes how the enterprise bean (or beans) in the `ejb-jar/.war` file is composed into a larger application deployment unit. Providing assembly information—whether in metadata annotations or in the deployment descriptor—is optional for the `ejb-jar` file producer. Assembly level information can be changed without breaking the enterprise bean's function, although doing so may alter the behavior of an assembled application.

19.2 Bean Provider's Responsibilities

The Bean Provider is responsible for providing in the deployment descriptor the following structural information for each enterprise bean if this information has not be provided in metadata annotations or is to be defaulted.

The Bean Provider uses the `enterprise-beans` element to list all the enterprise beans in the `ejb-jar/.war` file.

The Bean Provider must provide the following information for each enterprise bean:

- **Enterprise bean's name.** A logical name is assigned to each enterprise bean in the `ejb-jar/.war` file. The Bean Provider can specify the enterprise bean's name in the `ejb-name` element. If the enterprise bean's name is not explicitly specified in metadata annotations or in the deployment descriptor, it defaults to the unqualified name of the bean class.
- **Enterprise bean's class.** If the bean class has not been annotated with the `Stateless`, `Stateful`, `Singleton`, or `Message-driven` annotation, the Bean Provider must use the `ejb-class` element of the `session` or `message-driven` deployment descriptor element to specify the fully-qualified name of the Java class that implements the enterprise bean's business methods. The Bean Provider specifies the enterprise bean's class name in the `ejb-class` element. The Bean Provider must use this element for an EJB 2.1 and earlier entity bean.
- **Enterprise bean's local business interface.** If the bean class has a local business interface and neither implements the business interface nor specifies it as a local business interface using metadata annotations on the bean class, the Bean Provider must specify the fully-qualified name of the enterprise bean's local business interface in the `business-local` element.

- **Enterprise bean's remote business interface.** If the bean class has a remote business interface and neither implements nor specifies it as a remote business interface using metadata annotations on the bean class, the Bean Provider must specify the fully-qualified name of the enterprise bean's remote business interface in the `business-remote` element.
- **Enterprise bean's remote home interface.** If the bean class has a remote home interface, and the remote home interface has not been specified using metadata annotations, the Bean Provider must specify the fully-qualified name of the enterprise bean's remote home interface in the `home` element.
- **Enterprise bean's remote interface.** If the bean class has a remote interface, and the remote home interface has not been specified using metadata annotations, the Bean Provider must specify the fully-qualified name of the enterprise bean's remote interface in the `remote` element.
- **Enterprise bean's local home interface.** If the bean class has a local home interface, and the local home interface has not been specified using metadata annotations, the Bean Provider must specify the fully-qualified name of the enterprise bean's local home interface in the `local-home` element.
- **Enterprise bean's local interface.** If the bean class has a local interface, and the local home interface has not been specified using metadata annotations, the Bean Provider must specify the fully-qualified name of the enterprise bean's local interface in the `local` element.
- **Enterprise bean's no-interface view.** If the bean class exposes a no-interface view and the bean exposes at least one other client view (Local, Remote, 2.x Local Home, 2.x Remote Home, Web Service), the bean class does not have an empty `implements` clause nor specifies there is a no-interface view using metadata annotations on the bean class, or `metadata-complete` has been set to true, the Bean Provider must specify the `local-bean` element.
- **Enterprise bean's web service endpoint interface.** If the bean class has a web service endpoint interface, and the interface has not been specified using metadata annotations on the bean class, the Bean Provider must specify the fully-qualified name of the enterprise bean's web service endpoint interface, in the `service-endpoint` element. This element may only be used for stateless session beans.
- **Enterprise bean's type.** The enterprise bean types are: session, entity, and message-driven. The Bean Provider must use the appropriate `session`, `entity`, or `message-driven` element to declare the enterprise bean's structural information if annotations have not been used for this purpose. If the bean's type has been specified by means of the `Stateless`, `Stateful`, `Singleton`, or `MessageDriven` annotation, its type cannot be overridden by means of the deployment descriptor. The bean's type (and its session type), if specified must be the same as that specified in annotations.
- **Re-entrancy indication.** The Bean Provider must specify whether an EJB 2.1 entity bean is re-entrant or not. Session beans and message-driven beans are never re-entrant.
- **Session bean's state management type.** If the enterprise bean is a session bean and the bean class has not been annotated with the `Stateful` or `Stateless` or `Singleton` **anno-**

tation, the Bean Provider must use the `session-type` element to declare whether the session bean is stateful or stateless or singleton.

- **Session or message-driven bean's transaction demarcation type.** If the enterprise bean is a session bean or message-driven bean, the Bean Provider may use the `transaction-type` element to declare whether transaction demarcation is performed by the enterprise bean or by the container. If neither the `TransactionType` annotation is used nor the `transaction-type` deployment descriptor element, the bean will have container managed transaction demarcation.
- **Session bean's concurrency management type.** If the enterprise bean is a Singleton session bean, the Bean Provider may use the `concurrency-management-type` element to declare whether concurrency management is handled by the container or is performed by the bean developer. If neither the `ConcurrencyManagement` annotation is used nor the `concurrency-management-type` deployment descriptor element, the Singleton bean will have container-managed concurrency.
- **Entity bean's persistence management.** If the enterprise bean is an EJB 2.1 entity bean, the Bean Provider must use the `persistence-type` element to declare whether persistence management is performed by the enterprise bean or by the container.
- **Entity bean's primary key class.** If the enterprise bean is an EJB 2.1 entity bean, the Bean Provider specifies the fully-qualified name of the entity bean's primary key class in the `prim-key-class` element. The Bean Provider *must* specify the primary key class for an entity with bean-managed persistence.
- **Entity bean's abstract schema name.** If the enterprise bean is an entity bean with container-managed persistence and `cmp-version 2.x`, the Bean Provider must specify the abstract schema name of the entity bean using the `abstract-schema-name` element.
- **Container-managed fields.** If the enterprise bean is an entity bean with container-managed persistence, the Bean Provider must specify the container-managed fields using the `cmp-field` elements.
- **Container-managed relationships.** If the enterprise bean is an entity bean with container-managed persistence and `cmp-version 2.x`, the Bean Provider must specify the container-managed relationships of the entity bean using the `relationships` element.
- **Finder and select queries.** If the enterprise bean is an entity bean with container-managed persistence and `cmp-version 2.x`, the Bean Provider must use the `query` element to specify any EJB QL finder or select query for the entity bean other than a query for the `findByPrimaryKey` method.
- **Environment entries.** The Bean Provider must declare any enterprise bean's environment entries that have not been defined by means of metadata annotations, as specified in Subsection 16.3.1.
- **Resource manager connection factory references.** The Bean Provider must declare any enterprise bean's resource manager connection factory references that have not been defined by means of metadata annotations, as specified in Subsection 16.7.1.

- **Resource environment references.** The Bean Provider must declare any enterprise bean's references to administered objects that are associated with resources and that have not been defined by means of metadata annotations, as specified in Subsection 16.8.1.
- **EJB references.** The Bean Provider must declare any enterprise bean's references to the remote home or remote business view of other enterprise beans that have not been defined by means of metadata annotations, as specified in Subsection 16.5.1.
- **EJB local references.** The Bean Provider must declare any enterprise bean's references to the local home or local business or no-interface view of other enterprise beans that have not been defined by means of metadata annotations, as specified in Subsection 16.5.1.
- **Web service references.** The Bean Provider must declare any enterprise bean's references to web service interfaces that have not been defined by means of metadata annotations, as specified in Subsection 16.6.
- **Persistence unit references.** The Bean Provider must declare any enterprise bean's references to an entity manager factory for a persistence unit that have not been defined by means of metadata annotations, as specified in Subsection 16.10.
- **Persistence context references.** The Bean Provider must declare any enterprise bean's references to an entity manager for a persistence context that have not been defined by means of metadata annotations, as specified in Subsection 16.11.
- **Message destination references.** The Bean Provider must declare any enterprise bean's references to message destinations that have not been defined by means of metadata annotations, as specified in Subsection 16.9.1.
- **Security role references.** The Bean Provider must declare any enterprise bean's references to security roles that have not been defined by means of metadata annotations, as specified in Subsection 17.2.5.3.
- **Message-driven bean's configuration properties.** The Bean Provider may provide input to the Deployer as to how a message-driven bean should be configured upon activation in its operational environment. Activation configuration properties for a JMS message-driven bean include information about a bean's intended destination type, its message selector, and its acknowledgement mode. Other bean types may make use of different properties. See [15].
- **Message-driven bean's destination.** The Bean Provider may provide advice to the Application Assembler as to the destination type to which a message-driven bean should be assigned when linking message destinations
- **Interceptors.** The Bean Provider must declare any interceptor classes and methods that have not been declared by means of metadata annotations.
- **Schedule-based timers.** The Bean Provider must declare any automatic schedule-based timers that have not been declared by means of metadata annotations.
- **Asynchronous methods.** The Bean Provider must declare any asynchronous business methods that have not been designated as asynchronous by means of metadata annotations.

- **Singleton initialization ordering dependencies.** The Bean Provider may provide advice to the Application Assembler as to the singleton initialization ordering dependencies.

The deployment descriptor produced by the Bean Provider must conform to the XML Schema definition in Section 19.5 or to the XML Schema or DTD definition from a previous version of this specification. The content of the deployment descriptor must conform to the semantics rules specified in the XML Schema or DTD comments and elsewhere in this specification.

19.3 Application Assembler's Responsibility

The Application Assembler assembles enterprise beans into a single deployment unit. The Application Assembler's input is one or more `ejb-jar/.war` files provided by one or more Bean Providers, and the output is also one or more `ejb-jar/.war` files. The Application Assembler can combine multiple input `ejb-jar/.war` files into a single output `ejb-jar/.war` file, or split an input `ejb-jar/.war` file into multiple output `ejb-jar/.war` files. Each output `ejb-jar/.war` file is either a deployment unit intended for the Deployer, or a partially assembled application that is intended for another Application Assembler.

The Bean Provider and Application Assembler may be the same person or organization. In such a case, the person or organization performs the responsibilities described both in this and the previous sections.

The Application Assembler may modify the following information that was specified by the Bean Provider:

- **Values of environment entries.** The Application Assembler may change existing and/or define new values of environment properties.
- **Description fields.** The Application Assembler may change existing or create new description elements.
- **Relationship names for EJB 2.x entity beans.** If multiple `ejb-jar` files use the same names for relationships and are merged into a single `ejb-jar` file, it is the responsibility of the Application Assembler to modify the relationship names defined in the `ejb-relation-name` elements.
- **Message-driven bean message selector.** The Application Assembler may further restrict, but not replace, the value of the `messageSelector` `activation-config-property` element of a JMS message-driven bean—whether this was defined in metadata annotations or the deployment descriptor.
- **Timer schedule attributes.** The Application Assembler may override timer attributes, except the method to which a timer's timeouts have been assigned.

In general, the Application Assembler should never modify any of the following.

- **Enterprise bean's abstract schema name.** The Application Assembler should not change the enterprise bean's name defined in the `abstract-schema-name` element since EJB QL queries may depend on the content of this element.

- **Relationship role source element.** The Application Assembler should not change the value of an `ejb-name` element in the `relationship-role-source` element.

If any of these elements must be modified by the Application Assembler in order to resolve name clashes during the merging two `ejb-jar/.war` files into one, the Application Assembler must also modify all `ejb-ql` query strings that depend on the value of the modified element(s).

The Application Assembler must not, in general, modify any other information listed in Section 19.2 that was provided in the input `ejb-jar/.war` file.

The Application Assembler may, but is not required to, specify any of the following application assembly information:

- **Binding of enterprise bean references.** The Application Assembler may link an enterprise bean reference to another enterprise bean in the `ejb-jar/.war` file or in an `ejb-jar` file in the same Java EE application unit. The Application Assembler creates the link by adding the `ejb-link` element to the referencing bean. The Application Assembler uses the `ejb-name` of the referenced bean for the link. If there are multiple enterprise beans with the same `ejb-name`, the Application Assembler uses the path name specifying the location of the `ejb-jar` file that contains the referenced component. The path name is relative to the referencing `ejb-jar/.war` file. The Application Assembler appends the `ejb-name` of the referenced bean to the path name separated by `#`. This allows multiple beans with the same name to be uniquely identified.
- **Linking of message destination references.** The Application Assembler may link message consumers and producers through common message destinations specified in the `ejb-jar` file or in the same Java EE application unit. The Application Assembler creates the link by adding the `message-destination-link` element to the referencing bean.
- **Security roles.** The Application Assembler may define one or more security roles. The security roles define the *recommended* security roles for the clients of the enterprise beans. The Application Assembler defines the security roles using the `security-role` elements.
- **Method permissions.** The Application Assembler may define method permissions. Method permission is a binary relation between the security roles and the methods of the business interfaces, home interfaces, component interfaces, and/or web service endpoints of the enterprise beans. The Application Assembler defines method permissions using the `method-permission` elements. The Application Assembler may augment or override method permissions defined by the Bean Provider—whether in metadata annotations or in the deployment descriptor.
- **Singleton initialization ordering.** The Application Assembler may define or override the `depends-on` initialization ordering metadata for a Singleton.
- **Stateful timeout.** The Application Assembler may define or override the stateful timeout.
- **Singleton Startup.** The Application Assembler may override the eager startup designation of a Singleton.

- **Access Timeouts.** The Application Assembler may override the access timeout values for methods governed by container-managed concurrency semantics of Stateful and Singleton session beans.
- **Linking of security role references.** If the Application Assembler defines security roles in the deployment descriptor, the Application Assembler may link the security role references declared by the Bean Provider to the security roles. The Application Assembler defines these links using the `role-link` element.
- **Security identity.** The Application Assembler may specify whether the caller's security identity should be used for the execution of the methods of an enterprise bean or whether a specific run-as security identity should be used. The Application Assembler may override a security identity defined by the Bean Provider—whether in metadata annotations or in the deployment descriptor.
- **Transaction attributes.** The Application Assembler may define the value of the transaction attributes for the methods of the business interface, home interface, component interface, no-interface view, web service endpoint, and `TimedObject` interface of the enterprise beans that require container-managed transaction demarcation. All entity beans and the session and message-driven beans declared by the Bean Provider as transaction-type `Container` require container-managed transaction demarcation. The Application Assembler uses the `container-transaction` elements to declare the transaction attributes.
- **Interceptors.** The Application Assembler may override, augment, and/or reorder the interceptor methods defined by the Bean Provider—whether in metadata annotations or in the deployment descriptor.

If an input `ejb-jar/war` file contains application assembly information, the Application Assembler is allowed to change the application assembly information supplied in the input file. (This could happen when the input file was produced by another Application Assembler.)

The deployment descriptor produced by the Bean Provider must conform to the XML Schema definition in Section 19.5 or the XML Schema or DTD definition from a previous version of this specification. The content of the deployment descriptor must conform to the semantics rules specified in the XML Schema or DTD comments and elsewhere in this specification.

19.4 Container Provider's Responsibilities

The Container Provider provides tools that read and import the information contained in the XML deployment descriptor.

All EJB 3.1 implementations must support EJB 3.0, EJB 2.1, EJB 2.0, and EJB 1.1 as well as EJB 3.1 deployment descriptors. The definitions of the EJB 3.0, EJB 2.1, EJB 2.0, and EJB 1.1 deployment descriptors can be found in the Enterprise JavaBeans 3.0 specification [3].

19.5 Deployment Descriptor XML Schema

This section provides the XML Schema for the EJB 3.1 deployment descriptor. The comments in the XML Schema specify additional requirements for the syntax and semantics that cannot be easily expressed by the XML Schema mechanism.

The content of the XML elements is in general case sensitive (i.e., unless stated otherwise). This means, for example, that

```
<transaction-type>Container</transaction-type>
```

must be used, rather than:

```
<transaction-type>container</transaction-type>.
```

All valid ejb-jar deployment descriptors must conform to the XML Schema definition below or to the DTD definition from a previous version of this specification.

```
<?xml version="1.0" encoding="UTF-8"?>
<xsd:schema xmlns="http://www.w3.org/2001/XMLSchema"
  targetNamespace="http://java.sun.com/xml/ns/javaee"
  xmlns:javaee="http://java.sun.com/xml/ns/javaee"
  xmlns:xsd="http://www.w3.org/2001/XMLSchema"
  elementFormDefault="qualified"
  attributeFormDefault="unqualified"
  version="3.1">
  <xsd:annotation>
    <xsd:documentation>

      $Id$

    </xsd:documentation>
  </xsd:annotation>

  <xsd:annotation>
    <xsd:documentation>

      DO NOT ALTER OR REMOVE COPYRIGHT NOTICES OR THIS HEADER.

      Copyright 2003-2009 Sun Microsystems, Inc. All rights reserved.

      The contents of this file are subject to the terms of either the
      GNU General Public License Version 2 only ("GPL") or the Common
      Development and Distribution License("CDDL") (collectively, the
      "License"). You may not use this file except in compliance with
      the License. You can obtain a copy of the License at
      https://glassfish.dev.java.net/public/CDDL+GPL.html or
      glassfish/bootstrap/legal/LICENSE.txt. See the License for the
      specific language governing permissions and limitations under the
      License.

      When distributing the software, include this License Header
      Notice in each file and include the License file at
      glassfish/bootstrap/legal/LICENSE.txt. Sun designates this
      particular file as subject to the "Classpath" exception as
      provided by Sun in the GPL Version 2 section of the License file
      that accompanied this code. If applicable, add the following
      below the License Header, with the fields enclosed by brackets []
      replaced by your own identifying information:
      "Portions Copyrighted [year] [name of copyright owner]"

      Contributor(s) :

      If you wish your version of this file to be governed by only the
      CDDL or only the GPL Version 2, indicate your decision by adding
      "[Contributor] elects to include this software in this
      distribution under the [CDDL or GPL Version 2] license." If you
      don't indicate a single choice of license, a recipient has the
      option to distribute your version of this file under either the
      CDDL, the GPL Version 2 or to extend the choice of license to its
      licensees as provided above. However, if you add GPL Version 2
      code and therefore, elected the GPL Version 2 license, then the
      option applies only if the new code is made subject to such
      option by the copyright holder.

    </xsd:documentation>
  </xsd:annotation>
```



```

<xsd:annotation>
  <xsd:documentation>
<![CDATA[[
  This is the XML Schema for the EJB 3.1 deployment descriptor.

  All EJB deployment descriptors must indicate
  the schema by using the Java EE namespace:

  http://java.sun.com/xml/ns/javaee

  and by indicating the version of the schema by
  using the version element as shown below:

  <ejb-jar xmlns="http://java.sun.com/xml/ns/javaee"
  xmlns:xsi="http://www.w3.org/2001/XMLSchema-instance"
  xsi:schemaLocation="http://java.sun.com/xml/ns/javaee
  http://java.sun.com/xml/ns/javaee/ejb-jar_3_1.xsd"
  version="3.1">
  ...
</ejb-jar>

  The instance documents may indicate the published version of
  the schema using the xsi:schemaLocation attribute for the
  Java EE namespace with the following location:

  http://java.sun.com/xml/ns/javaee/ejb-jar_3_1.xsd
]]>
  </xsd:documentation>
</xsd:annotation>

<xsd:annotation>
  <xsd:documentation>

  The following conventions apply to all Java EE
  deployment descriptor elements unless indicated otherwise.

  - In elements that specify a pathname to a file within the
  same JAR file, relative filenames (i.e., those not
  starting with "/" ) are considered relative to the root of
  the JAR file's namespace. Absolute filenames (i.e., those
  starting with "/" ) also specify names in the root of the
  JAR file's namespace. In general, relative names are
  preferred. The exception is .war files where absolute
  names are preferred for consistency with the Servlet API.

  </xsd:documentation>
</xsd:annotation>

<xsd:include schemaLocation="javaee_6.xsd"/>

<!-- ***** -->

<xsd:element name="ejb-jar"
  type="javaee:ejb-jarType">
  <xsd:annotation>
    <xsd:documentation>

      This is the root of the ejb-jar deployment descriptor.

    </xsd:documentation>
  </xsd:annotation>
  <xsd:key name="ejb-name-key">
    <xsd:annotation>
      <xsd:documentation>

```

The `ejb-name` element contains the name of an enterprise bean. The name must be unique within the `ejb-jar` or `.war` file.

```

    </xsd:documentation>
  </xsd:annotation>
  <xsd:selector xpath="javaee:enterprise-beans/*"/>
  <xsd:field xpath="javaee:ejb-name"/>
</xsd:key>
<xsd:keyref name="ejb-name-references"
            refer="javaee:ejb-name-key">
  <xsd:annotation>
    <xsd:documentation>

```

The keyref indicates the references from `relationship-role-source` must be to a specific `ejb-name` defined within the scope of `enterprise-beans` element.

```

    </xsd:documentation>
  </xsd:annotation>
  <xsd:selector xpath="./javaee:ejb-relationship-role/javaee:relation-
ship-role-source"/>
  <xsd:field xpath="javaee:ejb-name"/>
</xsd:keyref>
<xsd:key name="role-name-key">
  <xsd:annotation>
    <xsd:documentation>

```

A `role-name-key` is specified to allow the references from the `security-role-refs`.

```

    </xsd:documentation>
  </xsd:annotation>
  <xsd:selector xpath="javaee:assembly-descriptor/javaee:security-role"/>
  <xsd:field xpath="javaee:role-name"/>
</xsd:key>
<xsd:keyref name="role-name-references"
            refer="javaee:role-name-key">
  <xsd:annotation>
    <xsd:documentation>

```

The keyref indicates the references from `security-role-ref` to a specified `role-name`.

```

    </xsd:documentation>
  </xsd:annotation>
  <xsd:selector xpath="javaee:enterprise-beans/*/javaee:secu-
rity-role-ref"/>
  <xsd:field xpath="javaee:role-link"/>
</xsd:keyref>
</xsd:element>

```

```
<!-- ***** -->
```

```

<xsd:complexType name="access-timeoutType">
  <xsd:annotation>
    <xsd:documentation>

```

The `access-timeoutType` represents the maximum amount of time (in a given time unit) that the container should wait for a concurrency lock before throwing a timeout exception to the client.

A timeout value of 0 means concurrent access is not permitted.

```

        A timeout value of -1 means wait indefinitely to acquire a lock.
    </xsd:documentation>
</xsd:annotation>
<xsd:sequence>
  <xsd:element name="timeout"
    type="javaee:xsdIntegerType"/>
  <xsd:element name="unit"
    type="javaee:time-unit-typeType"/>
</xsd:sequence>
<xsd:attribute name="id"
  type="xsd:ID"/>
</xsd:complexType>

<!-- ***** -->

<xsd:complexType name="async-methodType">
  <xsd:annotation>
    <xsd:documentation>

      The async-methodType element specifies that a session
      bean method has asynchronous invocation semantics.

    </xsd:documentation>
  </xsd:annotation>
  <xsd:sequence>
    <xsd:element name="method-name"
      type="javaee:string"/>
    <xsd:element name="method-params"
      type="javaee:method-paramsType"
      minOccurs="0"/>
  </xsd:sequence>
  <xsd:attribute name="id"
    type="xsd:ID"/>
</xsd:complexType>

<!-- ***** -->

<xsd:complexType name="activation-configType">
  <xsd:annotation>
    <xsd:documentation>

      The activation-configType defines information about the
      expected configuration properties of the message-driven bean
      in its operational environment. This may include information
      about message acknowledgement, message selector, expected
      destination type, etc.

      The configuration information is expressed in terms of
      name/value configuration properties.

      The properties that are recognized for a particular
      message-driven bean are determined by the messaging type.

    </xsd:documentation>
  </xsd:annotation>
  <xsd:sequence>
    <xsd:element name="description"
      type="javaee:descriptionType"
      minOccurs="0"
      maxOccurs="unbounded"/>
    <xsd:element name="activation-config-property"
      type="javaee:activation-config-propertyType"

```

```

        maxOccurs="unbounded"/>
    </xsd:sequence>
    <xsd:attribute name="id"
        type="xsd:ID"/>
</xsd:complexType>

<!-- ***** -->

<xsd:complexType name="activation-config-propertyType">
    <xsd:annotation>
        <xsd:documentation>

            The activation-config-propertyType contains a name/value
            configuration property pair for a message-driven bean.

            The properties that are recognized for a particular
            message-driven bean are determined by the messaging type.

        </xsd:documentation>
    </xsd:annotation>
    <xsd:sequence>
        <xsd:element name="activation-config-property-name"
            type="javaee:xsdStringType">
            <xsd:annotation>
                <xsd:documentation>

                    The activation-config-property-name element contains
                    the name for an activation configuration property of
                    a message-driven bean.

                    For JMS message-driven beans, the following property
                    names are recognized: acknowledgeMode,
                    messageSelector, destinationType, subscriptionDurability

                </xsd:documentation>
            </xsd:annotation>
        </xsd:element>
        <xsd:element name="activation-config-property-value"
            type="javaee:xsdStringType">
            <xsd:annotation>
                <xsd:documentation>

                    The activation-config-property-value element
                    contains the value for an activation configuration
                    property of a message-driven bean.

                </xsd:documentation>
            </xsd:annotation>
        </xsd:element>
    </xsd:sequence>
    <xsd:attribute name="id"
        type="xsd:ID"/>
</xsd:complexType>

<!-- ***** -->

<xsd:complexType name="around-invokeType">
    <xsd:annotation>
        <xsd:documentation>

            The around-invoke type specifies a method on a
            class to be called during the around invoke portion of an
            ejb invocation. Note that each class may have only one
            around invoke method and that the method may not be

```

```

        overloaded.

        If the class element is missing then
        the class defining the callback is assumed to be the
        interceptor class or component class in scope at the
        location in the descriptor in which the around invoke
        definition appears.

        </xsd:documentation>
    </xsd:annotation>
    <xsd:sequence>
        <xsd:element name="class"
            type="javaee:fully-qualified-classType"
            minOccurs="0"/>
        <xsd:element name="method-name"
            type="javaee:java-identifierType"/>
    </xsd:sequence>
</xsd:complexType>

<!-- ***** -->

<xsd:complexType name="around-timeoutType">
    <xsd:annotation>
        <xsd:documentation>

            The around-timeout type specifies a method on a
            class to be called during the around-timeout portion of
            a timer timeout callback. Note that each class may have
            only one around-timeout method and that the method may not
            be overloaded.

            If the class element is missing then
            the class defining the callback is assumed to be the
            interceptor class or component class in scope at the
            location in the descriptor in which the around-timeout
            definition appears.

        </xsd:documentation>
    </xsd:annotation>
    <xsd:sequence>
        <xsd:element name="class"
            type="javaee:fully-qualified-classType"
            minOccurs="0"/>
        <xsd:element name="method-name"
            type="javaee:java-identifierType"/>
    </xsd:sequence>
</xsd:complexType>

<!-- ***** -->

<xsd:complexType name="assembly-descriptorType">
    <xsd:annotation>
        <xsd:documentation>

            The assembly-descriptorType defines
            application-assembly information.

            The application-assembly information consists of the
            following parts: the definition of security roles, the
            definition of method permissions, the definition of
            transaction attributes for enterprise beans with
            container-managed transaction demarcation, the definition
            of interceptor bindings, a list of
            methods to be excluded from being invoked, and a list of

```

exception types that should be treated as application exceptions.

All the parts are optional in the sense that they are omitted if the lists represented by them are empty.

Providing an assembly-descriptor in the deployment descriptor is optional for the ejb-jar or .war file producer.

```

</xsd:documentation>
</xsd:annotation>
<xsd:sequence>
  <xsd:element name="security-role"
    type="javaee:security-roleType"
    minOccurs="0"
    maxOccurs="unbounded"/>
  <xsd:element name="method-permission"
    type="javaee:method-permissionType"
    minOccurs="0"
    maxOccurs="unbounded"/>
  <xsd:element name="container-transaction"
    type="javaee:container-transactionType"
    minOccurs="0"
    maxOccurs="unbounded"/>
  <xsd:element name="interceptor-binding"
    type="javaee:interceptor-bindingType"
    minOccurs="0"
    maxOccurs="unbounded"/>
  <xsd:element name="message-destination"
    type="javaee:message-destinationType"
    minOccurs="0"
    maxOccurs="unbounded"/>
  <xsd:element name="exclude-list"
    type="javaee:exclude-listType"
    minOccurs="0"/>
  <xsd:element name="application-exception"
    type="javaee:application-exceptionType"
    minOccurs="0"
    maxOccurs="unbounded"/>
</xsd:sequence>
<xsd:attribute name="id"
  type="xsd:ID"/>
</xsd:complexType>

<!-- ***** -->

<xsd:complexType name="cmp-fieldType">
  <xsd:annotation>
    <xsd:documentation>

      The cmp-fieldType describes a container-managed field. The
      cmp-fieldType contains an optional description of the field,
      and the name of the field.

    </xsd:documentation>
  </xsd:annotation>
  <xsd:sequence>
    <xsd:element name="description"
      type="javaee:descriptionType"
      minOccurs="0"
      maxOccurs="unbounded"/>
    <xsd:element name="field-name"
      type="javaee:java-identifierType">
      <xsd:annotation>
        <xsd:documentation>

```

The field-name element specifies the name of a container managed field.

The name of the cmp-field of an entity bean with cmp-version 2.x must begin with a lowercase letter. This field is accessed by methods whose names consists of the name of the field specified by field-name in which the first letter is uppercased, prefixed by "get" or "set".

The name of the cmp-field of an entity bean with cmp-version 1.x must denote a public field of the enterprise bean class or one of its superclasses.

```

    </xsd:documentation>
  </xsd:annotation>
</xsd:element>
</xsd:sequence>
<xsd:attribute name="id"
               type="xsd:ID"/>
</xsd:complexType>

```

```
<!-- ***** -->
```

```

<xsd:complexType name="cmp-versionType">
  <xsd:annotation>
    <xsd:documentation>

      The cmp-versionType specifies the version of an entity bean
      with container-managed persistence. It is used by
      cmp-version elements.

      The value must be one of the two following:

      1.x
      2.x

    </xsd:documentation>
  </xsd:annotation>
  <xsd:simpleContent>
    <xsd:restriction base="javaee:string">
      <xsd:enumeration value="1.x"/>
      <xsd:enumeration value="2.x"/>
    </xsd:restriction>
  </xsd:simpleContent>
</xsd:complexType>

```

```
<!-- ***** -->
```

```

<xsd:complexType name="cmr-fieldType">
  <xsd:annotation>
    <xsd:documentation>

      The cmr-fieldType describes the bean provider's view of
      a relationship. It consists of an optional description, and
      the name and the class type of a field in the source of a
      role of a relationship. The cmr-field-name element
      corresponds to the name used for the get and set accessor
      methods for the relationship. The cmr-field-type element is
      used only for collection-valued cmr-fields. It specifies the
      type of the collection that is used.

    </xsd:documentation>
  </xsd:annotation>

```

```

    <xsd:sequence>
      <xsd:element name="description"
        type="javaee:descriptionType"
        minOccurs="0"
        maxOccurs="unbounded"/>
      <xsd:element name="cmr-field-name"
        type="javaee:string">
        <xsd:annotation>
          <xsd:documentation>

            The cmr-field-name element specifies the name of a
            logical relationship field in the entity bean
            class. The name of the cmr-field must begin with a
            lowercase letter. This field is accessed by methods
            whose names consist of the name of the field
            specified by cmr-field-name in which the first
            letter is uppercased, prefixed by "get" or "set".

          </xsd:documentation>
        </xsd:annotation>
      </xsd:element>
      <xsd:element name="cmr-field-type"
        type="javaee:cmr-field-typeType"
        minOccurs="0"/>
    </xsd:sequence>
    <xsd:attribute name="id"
      type="xsd:ID"/>
  </xsd:complexType>

<!-- ***** -->

  <xsd:complexType name="cmr-field-typeType">
    <xsd:annotation>
      <xsd:documentation>

        The cmr-field-type element specifies the class of a
        collection-valued logical relationship field in the entity
        bean class. The value of an element using cmr-field-typeType
        must be either: java.util.Collection or java.util.Set.

      </xsd:documentation>
    </xsd:annotation>
    <xsd:simpleContent>
      <xsd:restriction base="javaee:string">
        <xsd:enumeration value="java.util.Collection"/>
        <xsd:enumeration value="java.util.Set"/>
      </xsd:restriction>
    </xsd:simpleContent>
  </xsd:complexType>

<!-- ***** -->

  <xsd:complexType name="concurrency-management-typeType">
    <xsd:annotation>
      <xsd:documentation>

        The concurrency-management-typeType specifies the way concurrency
        is managed for a singleton or stateful session bean.

        The concurrency management type must be one of the following:

        Bean
        Container

```



```

        Bean managed concurrency can only be specified for a singleton bean.
    </xsd:documentation>
</xsd:annotation>
<xsd:simpleContent>
    <xsd:restriction base="javaee:string">
        <xsd:enumeration value="Bean"/>
        <xsd:enumeration value="Container"/>
    </xsd:restriction>
</xsd:simpleContent>
</xsd:complexType>

<!-- ***** -->

<xsd:complexType name="concurrent-lock-typeType">
    <xsd:annotation>
        <xsd:documentation>

            The concurrent-lock-typeType specifies how the container must
            manage concurrent access to a method of a Singleton bean
            with container-managed concurrency.

            The container managed concurrency lock type must be one
            of the following :

            Read
            Write

        </xsd:documentation>
    </xsd:annotation>
    <xsd:simpleContent>
        <xsd:restriction base="javaee:string">
            <xsd:enumeration value="Read"/>
            <xsd:enumeration value="Write"/>
        </xsd:restriction>
    </xsd:simpleContent>
</xsd:complexType>

<!-- ***** -->

<xsd:complexType name="concurrent-methodType">
    <xsd:annotation>
        <xsd:documentation>

            The concurrent-methodType specifies information about a method
            of a bean with container managed concurrency.

            The optional lock element specifies the kind of concurrency
            lock associated with the method.

            The optional access-timeout element specifies the amount of
            time (in a given time unit) the container should wait for a
            concurrency lock before throwing an exception to the client.

        </xsd:documentation>
    </xsd:annotation>
    <xsd:sequence>
        <xsd:element name="method"
            type="javaee:named-methodType"/>
        <xsd:element name="lock"
            type="javaee:concurrent-lock-typeType"
            minOccurs="0"/>
        <xsd:element name="access-timeout"
            type="javaee:access-timeoutType"

```

```

        minOccurs="0"/>
    </xsd:sequence>
    <xsd:attribute name="id"
        type="xsd:ID"/>
</xsd:complexType>

<!-- ***** -->

<xsd:complexType name="container-transactionType">
    <xsd:annotation>
        <xsd:documentation>

            The container-transactionType specifies how the container
            must manage transaction scopes for the enterprise bean's
            method invocations. It defines an optional description, a
            list of method elements, and a transaction attribute. The
            transaction attribute is to be applied to all the specified
            methods.

        </xsd:documentation>
    </xsd:annotation>
    <xsd:sequence>
        <xsd:element name="description"
            type="javaee:descriptionType"
            minOccurs="0"
            maxOccurs="unbounded"/>
        <xsd:element name="method"
            type="javaee:methodType"
            maxOccurs="unbounded"/>
        <xsd:element name="trans-attribute"
            type="javaee:trans-attributeType"/>
    </xsd:sequence>
    <xsd:attribute name="id"
        type="xsd:ID"/>
</xsd:complexType>

<!-- ***** -->

<xsd:complexType name="depends-onType">
    <xsd:annotation>
        <xsd:documentation>

            The depends-onType is used to express initialization
            ordering dependencies between Singleton components.
            The depends-onType specifies the names of one or more
            Singleton beans in the same application as the referring
            Singleton, each of which must be initialized before
            the referring bean.

            Each dependent bean is expressed using ejb-link syntax.
            The order in which dependent beans are initialized at
            runtime is not guaranteed to match the order in which
            they are listed.

        </xsd:documentation>
    </xsd:annotation>
    <xsd:sequence>
        <xsd:element name="ejb-name"
            type="javaee:ejb-linkType"
            minOccurs="1"
            maxOccurs="unbounded"/>
    </xsd:sequence>
    <xsd:attribute name="id"
        type="xsd:ID"/>

```

```

</xsd:complexType>

<!-- ***** -->

<xsd:complexType name="ejb-classType">
  <xsd:annotation>
    <xsd:documentation>
<![CDATA[[
  The ejb-classType contains the fully-qualified name of the
  enterprise bean's class. It is used by ejb-class elements.

  Example:

  <ejb-class>com.wombat.empl.EmployeeServiceBean</ejb-class>
]]>
    </xsd:documentation>
  </xsd:annotation>
  <xsd:simpleContent>
    <xsd:restriction base="javaee:fully-qualified-classType"/>
  </xsd:simpleContent>
</xsd:complexType>

<!-- ***** -->

<xsd:complexType name="ejb-jarType">
  <xsd:annotation>
    <xsd:documentation>

      The ejb-jarType defines the root element of the EJB
      deployment descriptor. It contains

      - an optional description of the ejb-jar file
      - an optional display name
      - an optional icon that contains a small and a large
        icon file name
      - an optional module name. Only applicable to
        stand-alone ejb-jars or ejb-jars packaged in an ear.
        Ignored if specified for an ejb-jar.xml within a .war.
        In that case, standard .war module-name rules apply.
      - structural information about all included
        enterprise beans that is not specified through
        annotations
      - structural information about interceptor classes
      - a descriptor for container managed relationships,
        if any.
      - an optional application-assembly descriptor
      - an optional name of an ejb-client-jar file for the
        ejb-jar.

    </xsd:documentation>
  </xsd:annotation>
  <xsd:sequence>
    <xsd:element name="module-name"
      type="javaee:string"
      minOccurs="0"/>
    <xsd:group ref="javaee:descriptionGroup"/>
    <xsd:element name="enterprise-beans"
      type="javaee:enterprise-beansType"
      minOccurs="0"/>
    <xsd:element name="interceptors"
      type="javaee:interceptorsType"
      minOccurs="0"/>
    <xsd:element name="relationships"

```

```

        type="javaee:relationshipsType"
        minOccurs="0">
<xsd:unique name="relationship-name-uniqueness">
  <xsd:annotation>
    <xsd:documentation>

      The ejb-relation-name contains the name of a
      relation. The name must be unique within
      relationships.

    </xsd:documentation>
  </xsd:annotation>
  <xsd:selector xpath="javaee:ejb-relation"/>
  <xsd:field xpath="javaee:ejb-relation-name"/>
</xsd:unique>
</xsd:element>
<xsd:element name="assembly-descriptor"
  type="javaee:assembly-descriptorType"
  minOccurs="0">
<xsd:annotation>
  <xsd:documentation>

    Providing an assembly-descriptor in the deployment
    descriptor is optional for the ejb-jar or .war file
    producer.

  </xsd:documentation>
</xsd:annotation>
</xsd:element>
<xsd:element name="ejb-client-jar"
  type="javaee:pathType"
  minOccurs="0">
<xsd:annotation>
  <xsd:documentation>
<![CDATA[[
  The optional ejb-client-jar element specifies a JAR
  file that contains the class files necessary for a
  client program to access the
  enterprise beans in the ejb-jar file.

  Example:

    <ejb-client-jar>employee_service_client.jar
    </ejb-client-jar>

]]>
  </xsd:documentation>
</xsd:annotation>
</xsd:element>
</xsd:sequence>
<xsd:attribute name="version"
  type="javaee:dewey-versionType"
  fixed="3.1"
  use="required">
<xsd:annotation>
  <xsd:documentation>

    The version specifies the version of the
    EJB specification that the instance document must
    comply with. This information enables deployment tools
    to validate a particular EJB Deployment
    Descriptor with respect to a specific version of the EJB
    schema.

  </xsd:documentation>
</xsd:annotation>

```

```

</xsd:attribute>
<xsd:attribute name="metadata-complete"
  type="xsd:boolean">
  <xsd:annotation>
    <xsd:documentation>

      The metadata-complete attribute defines whether this
      deployment descriptor and other related deployment
      descriptors for this module (e.g., web service
      descriptors) are complete, or whether the class
      files available to this module and packaged with
      this application should be examined for annotations
      that specify deployment information.

      If metadata-complete is set to "true", the deployment
      tool must ignore any annotations that specify deployment
      information, which might be present in the class files
      of the application.

      If metadata-complete is not specified or is set to
      "false", the deployment tool must examine the class
      files of the application for annotations, as
      specified by the specifications.

    </xsd:documentation>
  </xsd:annotation>
</xsd:attribute>
<xsd:attribute name="id"
  type="xsd:ID"/>
</xsd:complexType>

<!-- ***** -->

<xsd:complexType name="ejb-nameType">
  <xsd:annotation>
    <xsd:documentation>
<![CDATA[[
  The ejb-nameType specifies an enterprise bean's name. It is
  used by ejb-name elements. This name is assigned by the
  file producer to name the enterprise bean in the
  ejb-jar or .war file's deployment descriptor. The name must be
  unique among the names of the enterprise beans in the same
  ejb-jar or .war file.

  There is no architected relationship between the used
  ejb-name in the deployment descriptor and the JNDI name that
  the Deployer will assign to the enterprise bean's home.

  The name for an entity bean must conform to the lexical
  rules for an NMTOKEN.

  Example:

  <ejb-name>EmployeeService</ejb-name>

]]>
  </xsd:documentation>
</xsd:annotation>
<xsd:simpleContent>
  <xsd:restriction base="javaee:xsdNMTOKENType"/>
</xsd:simpleContent>
</xsd:complexType>

<!-- ***** -->

```

```

<xsd:complexType name="ejb-relationType">
  <xsd:annotation>
    <xsd:documentation>

      The ejb-relationType describes a relationship between two
      entity beans with container-managed persistence. It is used
      by ejb-relation elements. It contains a description; an
      optional ejb-relation-name element; and exactly two
      relationship role declarations, defined by the
      ejb-relationship-role elements. The name of the
      relationship, if specified, is unique within the ejb-jar
      file.

    </xsd:documentation>
  </xsd:annotation>
  <xsd:sequence>
    <xsd:element name="description"
      type="javaee:descriptionType"
      minOccurs="0"
      maxOccurs="unbounded"/>
    <xsd:element name="ejb-relation-name"
      type="javaee:string"
      minOccurs="0">
      <xsd:annotation>
        <xsd:documentation>

          The ejb-relation-name element provides a unique name
          within the ejb-jar file for a relationship.

        </xsd:documentation>
      </xsd:annotation>
    </xsd:element>
    <xsd:element name="ejb-relationship-role"
      type="javaee:ejb-relationship-roleType"/>
    <xsd:element name="ejb-relationship-role"
      type="javaee:ejb-relationship-roleType"/>
  </xsd:sequence>
  <xsd:attribute name="id"
    type="xsd:ID"/>
</xsd:complexType>

<!-- ***** -->

<xsd:complexType name="ejb-relationship-roleType">
  <xsd:annotation>
    <xsd:documentation>
<![CDATA[[
  The ejb-relationship-roleType describes a role within a
  relationship. There are two roles in each relationship.

  The ejb-relationship-roleType contains an optional
  description; an optional name for the relationship role; a
  specification of the multiplicity of the role; an optional
  specification of cascade-delete functionality for the role;
  the role source; and a declaration of the cmr-field, if any,
  by means of which the other side of the relationship is
  accessed from the perspective of the role source.

  The multiplicity and role-source element are mandatory.

  The relationship-role-source element designates an entity
  bean by means of an ejb-name element. For bidirectional
  relationships, both roles of a relationship must declare a
  relationship-role-source element that specifies a cmr-field

```

in terms of which the relationship is accessed. The lack of a `cmr-field` element in an `ejb-relationship-role` specifies that the relationship is unidirectional in navigability and the entity bean that participates in the relationship is "not aware" of the relationship.

Example:

```

<ejb-relation>
<ejb-relation-name>Product-LineItem</ejb-relation-name>
<ejb-relationship-role>
  <ejb-relationship-role-name>product-has-lineitems
  </ejb-relationship-role-name>
  <multiplicity>One</multiplicity>
  <relationship-role-source>
  <ejb-name>ProductEJB</ejb-name>
  </relationship-role-source>
</ejb-relationship-role>
</ejb-relation>
]]>
  </xsd:documentation>
</xsd:annotation>
<xsd:sequence>
  <xsd:element name="description"
    type="javaee:descriptionType"
    minOccurs="0"
    maxOccurs="unbounded"/>
  <xsd:element name="ejb-relationship-role-name"
    type="javaee:string"
    minOccurs="0">
    <xsd:annotation>
      <xsd:documentation>

        The ejb-relationship-role-name element defines a
        name for a role that is unique within an
        ejb-relation. Different relationships can use the
        same name for a role.

      </xsd:documentation>
    </xsd:annotation>
  </xsd:element>
  <xsd:element name="multiplicity"
    type="javaee:multiplicityType"/>
  <xsd:element name="cascade-delete"
    type="javaee:emptyType"
    minOccurs="0">
    <xsd:annotation>
      <xsd:documentation>

        The cascade-delete element specifies that, within a
        particular relationship, the lifetime of one or more
        entity beans is dependent upon the lifetime of
        another entity bean. The cascade-delete element can
        only be specified for an ejb-relationship-role
        element contained in an ejb-relation element in
        which the other ejb-relationship-role
        element specifies a multiplicity of One.

      </xsd:documentation>
    </xsd:annotation>
  </xsd:element>
  <xsd:element name="relationship-role-source"
    type="javaee:relationship-role-sourceType"/>
  <xsd:element name="cmr-field"
    type="javaee:cmr-fieldType"

```

```

        minOccurs="0"/>
    </xsd:sequence>
    <xsd:attribute name="id"
        type="xsd:ID"/>
</xsd:complexType>

<!-- ***** -->

<xsd:complexType name="enterprise-beansType">
    <xsd:annotation>
        <xsd:documentation>

            The enterprise-beansType declares one or more enterprise
            beans. Each bean can be a session, entity or message-driven
            bean.

        </xsd:documentation>
    </xsd:annotation>
    <xsd:choice maxOccurs="unbounded">
        <xsd:element name="session"
            type="javaee:session-beanType">
            <xsd:unique name="session-ejb-local-ref-name-uniqueness">
                <xsd:annotation>
                    <xsd:documentation>

                        The ejb-ref-name element contains the name of
                        an EJB reference. The EJB reference is an entry in
                        the component's environment and is relative to the
                        java:comp/env context. The name must be unique within
                        the component.

                        It is recommended that name be prefixed with "ejb/".

                    </xsd:documentation>
                </xsd:annotation>
                <xsd:selector xpath="javaee:ejb-local-ref"/>
                <xsd:field xpath="javaee:ejb-ref-name"/>
            </xsd:unique>
            <xsd:unique name="session-ejb-ref-name-uniqueness">
                <xsd:annotation>
                    <xsd:documentation>

                        The ejb-ref-name element contains the name of an EJB
                        reference. The EJB reference is an entry in the
                        component's environment and is relative to the
                        java:comp/env context. The name must be unique
                        within the component.

                        It is recommended that name is prefixed with "ejb/".

                    </xsd:documentation>
                </xsd:annotation>
                <xsd:selector xpath="javaee:ejb-ref"/>
                <xsd:field xpath="javaee:ejb-ref-name"/>
            </xsd:unique>
            <xsd:unique name="session-resource-env-ref-name-uniqueness">
                <xsd:annotation>
                    <xsd:documentation>

                        The resource-env-ref-name element specifies the name
                        of a resource environment reference; its value is
                        the environment entry name used in the component
                        code. The name is a JNDI name relative to the
                        java:comp/env context and must be unique within an
                        component.

                    </xsd:documentation>
                </xsd:annotation>
            </xsd:unique>
        </xsd:choice>
    </xsd:complexType>

```



```

    </xsd:documentation>
  </xsd:annotation>
  <xsd:selector xpath="javaee:resource-env-ref"/>
  <xsd:field xpath="javaee:resource-env-ref-name"/>
</xsd:unique>
<xsd:unique name="session-message-destination-ref-uniqueness">
  <xsd:annotation>
    <xsd:documentation>

      The message-destination-ref-name element specifies the name
      of a message destination reference; its value is
      the message destination reference name used in the component
      code. The name is a JNDI name relative to the
      java:comp/env context and must be unique within an
      component.

    </xsd:documentation>
  </xsd:annotation>
  <xsd:selector xpath="javaee:message-destination-ref"/>
  <xsd:field xpath="javaee:message-destination-ref-name"/>
</xsd:unique>
<xsd:unique name="session-res-ref-name-uniqueness">
  <xsd:annotation>
    <xsd:documentation>

      The res-ref-name element specifies the name of a
      resource manager connection factory reference. The name
      is a JNDI name relative to the java:comp/env context.
      The name must be unique within an component.

    </xsd:documentation>
  </xsd:annotation>
  <xsd:selector xpath="javaee:resource-ref"/>
  <xsd:field xpath="javaee:res-ref-name"/>
</xsd:unique>
<xsd:unique name="session-env-entry-name-uniqueness">
  <xsd:annotation>
    <xsd:documentation>

      The env-entry-name element contains the name of a
      component's environment entry. The name is a JNDI
      name relative to the java:comp/env context. The
      name must be unique within an component.

    </xsd:documentation>
  </xsd:annotation>
  <xsd:selector xpath="javaee:env-entry"/>
  <xsd:field xpath="javaee:env-entry-name"/>
</xsd:unique>
</xsd:element>
<xsd:element name="entity"
  type="javaee:entity-beanType">
  <xsd:unique name="entity-ejb-local-ref-name-uniqueness">
    <xsd:annotation>
      <xsd:documentation>

        The ejb-ref-name element contains the name of
        an EJB reference. The EJB reference is an entry in
        the component's environment and is relative to the
        java:comp/env context. The name must be unique within
        the component.

        It is recommended that name be prefixed with "ejb/".

      </xsd:documentation>
    </xsd:annotation>
  </xsd:unique>

```

```

</xsd:annotation>
<xsd:selector xpath="javaee:ejb-local-ref"/>
<xsd:field xpath="javaee:ejb-ref-name"/>
</xsd:unique>
<xsd:unique name="entity-ejb-ref-name-uniqueness">
  <xsd:annotation>
    <xsd:documentation>

      The ejb-ref-name element contains the name of an EJB
      reference. The EJB reference is an entry in the
      component's environment and is relative to the
      java:comp/env context. The name must be unique
      within the component.

      It is recommended that name is prefixed with "ejb/".

    </xsd:documentation>
  </xsd:annotation>
  <xsd:selector xpath="javaee:ejb-ref"/>
  <xsd:field xpath="javaee:ejb-ref-name"/>
</xsd:unique>
<xsd:unique name="entity-resource-env-ref-uniqueness">
  <xsd:annotation>
    <xsd:documentation>

      The resource-env-ref-name element specifies the name
      of a resource environment reference; its value is
      the environment entry name used in the component
      code. The name is a JNDI name relative to the
      java:comp/env context and must be unique within an
      component.

    </xsd:documentation>
  </xsd:annotation>
  <xsd:selector xpath="javaee:resource-env-ref"/>
  <xsd:field xpath="javaee:resource-env-ref-name"/>
</xsd:unique>
<xsd:unique name="entity-message-destination-ref-uniqueness">
  <xsd:annotation>
    <xsd:documentation>

      The message-destination-ref-name element specifies the name
      of a message destination reference; its value is
      the message destination reference name used in the component
      code. The name is a JNDI name relative to the
      java:comp/env context and must be unique within an
      component.

    </xsd:documentation>
  </xsd:annotation>
  <xsd:selector xpath="javaee:message-destination-ref"/>
  <xsd:field xpath="javaee:message-destination-ref-name"/>
</xsd:unique>
<xsd:unique name="entity-res-ref-name-uniqueness">
  <xsd:annotation>
    <xsd:documentation>

      The res-ref-name element specifies the name of a
      resource manager connection factory reference. The name
      is a JNDI name relative to the java:comp/env context.
      The name must be unique within an component.

    </xsd:documentation>
  </xsd:annotation>
  <xsd:selector xpath="javaee:resource-ref"/>
  <xsd:field xpath="javaee:res-ref-name"/>

```

```

</xsd:unique>
<xsd:unique name="entity-env-entry-name-uniqueness">
  <xsd:annotation>
    <xsd:documentation>

      The env-entry-name element contains the name of a
      component's environment entry. The name is a JNDI
      name relative to the java:comp/env context. The
      name must be unique within an component.

    </xsd:documentation>
  </xsd:annotation>
  <xsd:selector xpath="javaee:env-entry"/>
  <xsd:field xpath="javaee:env-entry-name"/>
</xsd:unique>
</xsd:element>
<xsd:element name="message-driven"
  type="javaee:message-driven-beanType">
  <xsd:unique name="messaging-ejb-local-ref-name-uniqueness">
    <xsd:annotation>
      <xsd:documentation>

        The ejb-ref-name element contains the name of
        an EJB reference. The EJB reference is an entry in
        the component's environment and is relative to the
        java:comp/env context. The name must be unique within
        the component.

        It is recommended that name be prefixed with "ejb/".

      </xsd:documentation>
    </xsd:annotation>
    <xsd:selector xpath="javaee:ejb-local-ref"/>
    <xsd:field xpath="javaee:ejb-ref-name"/>
  </xsd:unique>
  <xsd:unique name="messaging-ejb-ref-name-uniqueness">
    <xsd:annotation>
      <xsd:documentation>

        The ejb-ref-name element contains the name of an EJB
        reference. The EJB reference is an entry in the
        component's environment and is relative to the
        java:comp/env context. The name must be unique
        within the component.

        It is recommended that name is prefixed with "ejb/".

      </xsd:documentation>
    </xsd:annotation>
    <xsd:selector xpath="javaee:ejb-ref"/>
    <xsd:field xpath="javaee:ejb-ref-name"/>
  </xsd:unique>
  <xsd:unique name="messaging-resource-env-ref-uniqueness">
    <xsd:annotation>
      <xsd:documentation>

        The resource-env-ref-name element specifies the name
        of a resource environment reference; its value is
        the environment entry name used in the component
        code. The name is a JNDI name relative to the
        java:comp/env context and must be unique within an
        component.

      </xsd:documentation>
    </xsd:annotation>
    <xsd:selector xpath="javaee:resource-env-ref"/>

```

```

    <xsd:field xpath="javaee:resource-env-ref-name"/>
  </xsd:unique>
  <xsd:unique name="messaging-message-destination-ref-uniqueness">
    <xsd:annotation>
      <xsd:documentation>

        The message-destination-ref-name element specifies the name
        of a message destination reference; its value is
        the message destination reference name used in the component
        code. The name is a JNDI name relative to the
        java:comp/env context and must be unique within an
        component.

      </xsd:documentation>
    </xsd:annotation>
    <xsd:selector xpath="javaee:message-destination-ref"/>
    <xsd:field xpath="javaee:message-destination-ref-name"/>
  </xsd:unique>
  <xsd:unique name="messaging-res-ref-name-uniqueness">
    <xsd:annotation>
      <xsd:documentation>

        The res-ref-name element specifies the name of a
        resource manager connection factory reference. The name
        is a JNDI name relative to the java:comp/env context.
        The name must be unique within an component.

      </xsd:documentation>
    </xsd:annotation>
    <xsd:selector xpath="javaee:resource-ref"/>
    <xsd:field xpath="javaee:res-ref-name"/>
  </xsd:unique>
  <xsd:unique name="messaging-env-entry-name-uniqueness">
    <xsd:annotation>
      <xsd:documentation>

        The env-entry-name element contains the name of a
        component's environment entry. The name is a JNDI
        name relative to the java:comp/env context. The
        name must be unique within an component.

      </xsd:documentation>
    </xsd:annotation>
    <xsd:selector xpath="javaee:env-entry"/>
    <xsd:field xpath="javaee:env-entry-name"/>
  </xsd:unique>
</xsd:element>
</xsd:choice>
<xsd:attribute name="id"
              type="xsd:ID"/>
</xsd:complexType>

<!-- ***** -->

<xsd:complexType name="entity-beanType">
  <xsd:annotation>
    <xsd:documentation>

      The entity-beanType declares an entity bean. The declaration
      consists of:

      - an optional description
      - an optional display name
      - an optional icon element that contains a small and a large
        icon file name

    </xsd:documentation>
  </xsd:annotation>

```

- a unique name assigned to the enterprise bean in the deployment descriptor
- an optional mapped-name element that can be used to provide vendor-specific deployment information such as the physical jndi-name of the entity bean's remote home interface. This element is not required to be supported by all implementations. Any use of this element is non-portable.
- the names of the entity bean's remote home and remote interfaces, if any
- the names of the entity bean's local home and local interfaces, if any
- the entity bean's implementation class
- the optional entity bean's persistence management type. If this element is not specified it is defaulted to Container.
- the entity bean's primary key class name
- an indication of the entity bean's reentrancy
- an optional specification of the entity bean's cmp-version
- an optional specification of the entity bean's abstract schema name
- an optional list of container-managed fields
- an optional specification of the primary key field
- an optional declaration of the bean's environment entries
- an optional declaration of the bean's EJB references
- an optional declaration of the bean's local EJB references
- an optional declaration of the bean's web service references
- an optional declaration of the security role references
- an optional declaration of the security identity to be used for the execution of the bean's methods
- an optional declaration of the bean's resource manager connection factory references
- an optional declaration of the bean's resource environment references
- an optional declaration of the bean's message destination references
- an optional set of query declarations for finder and select methods for an entity bean with cmp-version 2.x.

The optional abstract-schema-name element must be specified for an entity bean with container-managed persistence and cmp-version 2.x.

The optional primkey-field may be present in the descriptor if the entity's persistence-type is Container.

The optional cmp-version element may be present in the descriptor if the entity's persistence-type is Container. If the persistence-type is Container and the cmp-version element is not specified, its value defaults to 2.x.

The optional home and remote elements must be specified if the entity bean cmp-version is 1.x.

The optional home and remote elements must be specified if the entity bean has a remote home and remote interface.

The optional local-home and local elements must be specified if the entity bean has a local home and local interface.

Either both the local-home and the local elements or both the home and the remote elements must be specified.

The optional query elements must be present if the persistence-type is Container and the cmp-version is 2.x and query methods other than findByPrimaryKey have been defined for the entity bean.

The other elements that are optional are "optional" in the sense that they are omitted if the lists represented by them are empty.

At least one cmp-field element must be present in the descriptor if the entity's persistence-type is Container and the cmp-version is 1.x, and none must not be present if the entity's persistence-type is Bean.

```

</xsd:documentation>
</xsd:annotation>
<xsd:sequence>
  <xsd:group ref="javaee:descriptionGroup"/>
  <xsd:element name="ejb-name"
    type="javaee:ejb-nameType"/>
  <xsd:element name="mapped-name"
    type="javaee:xsdStringType"
    minOccurs="0"/>
  <xsd:element name="home"
    type="javaee:homeType"
    minOccurs="0"/>
  <xsd:element name="remote"
    type="javaee:remoteType"
    minOccurs="0"/>
  <xsd:element name="local-home"
    type="javaee:local-homeType"
    minOccurs="0"/>
  <xsd:element name="local"
    type="javaee:localType"
    minOccurs="0"/>
  <xsd:element name="ejb-class"
    type="javaee:ejb-classType"/>
  <xsd:element name="persistence-type"
    type="javaee:persistence-typeType"/>
  <xsd:element name="prim-key-class"
    type="javaee:fully-qualified-classType">
    <xsd:annotation>
      <xsd:documentation>

```

The prim-key-class element contains the fully-qualified name of an entity bean's primary key class.

If the definition of the primary key class is deferred to deployment time, the prim-key-class element should specify java.lang.Object.

```

    </xsd:documentation>
  </xsd:annotation>
</xsd:element>
<xsd:element name="reentrant"
  type="javaee:true-falseType">
  <xsd:annotation>
    <xsd:documentation>

```

The reentrant element specifies whether an entity bean is reentrant or not.

The reentrant element must be one of the two following: true or false

```

    </xsd:documentation>
  </xsd:annotation>
</xsd:element>
<xsd:element name="cmp-version"
  type="javaee:cmp-versionType"
  minOccurs="0"/>
<xsd:element name="abstract-schema-name"
  type="javaee:java-identifierType"
  minOccurs="0">
  <xsd:annotation>
    <xsd:documentation>

```

The abstract-schema-name element specifies the name of the abstract schema type of an entity bean with cmp-version 2.x. It is used in EJB QL queries.

For example, the abstract-schema-name for an entity bean whose local interface is com.acme.commerce.Order might be Order.

```

    </xsd:documentation>
  </xsd:annotation>
</xsd:element>
<xsd:element name="cmp-field"
  type="javaee:cmp-fieldType"
  minOccurs="0"
  maxOccurs="unbounded"/>
<xsd:element name="primkey-field"
  type="javaee:string"
  minOccurs="0">
  <xsd:annotation>
    <xsd:documentation>

```

The primkey-field element is used to specify the name of the primary key field for an entity with container-managed persistence.

The primkey-field must be one of the fields declared in the cmp-field element, and the type of the field must be the same as the primary key type.

The primkey-field element is not used if the primary key maps to multiple container-managed fields (i.e. the key is a compound key). In this case, the fields of the primary key class must be public, and their names must correspond to the field names of the entity bean class that comprise the key.

```

    </xsd:documentation>
  </xsd:annotation>
</xsd:element>
<xsd:group ref="javaee:jndiEnvironmentRefsGroup"/>
<xsd:element name="security-role-ref"
  type="javaee:security-role-refType"
  minOccurs="0"
  maxOccurs="unbounded"/>
<xsd:element name="security-identity"
  type="javaee:security-identityType"
  minOccurs="0"/>
<xsd:element name="query"
  type="javaee:queryType"
  minOccurs="0"
  maxOccurs="unbounded"/>

```

```

    </xsd:sequence>
    <xsd:attribute name="id"
                  type="xsd:ID"/>
  </xsd:complexType>

<!-- ***** -->

<xsd:complexType name="exclude-listType">
  <xsd:annotation>
    <xsd:documentation>

      The exclude-listType specifies one or more methods which
      the Assembler marks to be uncallable.

      If the method permission relation contains methods that are
      in the exclude list, the Deployer should consider those
      methods to be uncallable.

    </xsd:documentation>
  </xsd:annotation>
  <xsd:sequence>
    <xsd:element name="description"
                 type="javaee:descriptionType"
                 minOccurs="0"
                 maxOccurs="unbounded"/>
    <xsd:element name="method"
                 type="javaee:methodType"
                 maxOccurs="unbounded"/>
  </xsd:sequence>
  <xsd:attribute name="id"
                 type="xsd:ID"/>
</xsd:complexType>

<!-- ***** -->

<xsd:complexType name="application-exceptionType">
  <xsd:annotation>
    <xsd:documentation>

      The application-exceptionType declares an application
      exception. The declaration consists of:

      - the exception class. When the container receives
      an exception of this type, it is required to
      forward this exception as an application exception
      to the client regardless of whether it is a checked
      or unchecked exception.
      - an optional rollback element. If this element is
      set to true, the container must rollback the current
      transaction before forwarding the exception to the
      client. If not specified, it defaults to false.
      - an optional inherited element. If this element is
      set to true, subclasses of the exception class type
      are also automatically considered application
      exceptions (unless overridden at a lower level).
      If set to false, only the exception class type is
      considered an application-exception, not its
      exception subclasses. If not specified, this
      value defaults to true.

    </xsd:documentation>
  </xsd:annotation>
  <xsd:sequence>
    <xsd:element name="exception-class"

```



```

        type="javaee:fully-qualified-classType"/>
        <xsd:element name="rollback"
            type="javaee:true-falseType"
            minOccurs="0"/>
        <xsd:element name="inherited"
            type="javaee:true-falseType"
            minOccurs="0"/>
    </xsd:sequence>
    <xsd:attribute name="id"
        type="xsd:ID"/>
</xsd:complexType>

<!-- ***** -->

<xsd:complexType name="interceptorsType">
    <xsd:annotation>
        <xsd:documentation>

            The interceptorsType element declares one or more interceptor
            classes used by components within this ejb-jar or .war. The declara-
            tion
            consists of :

            - An optional description.
            - One or more interceptor elements.

        </xsd:documentation>
    </xsd:annotation>
    <xsd:sequence>
        <xsd:element name="description"
            type="javaee:descriptionType"
            minOccurs="0"
            maxOccurs="unbounded"/>
        <xsd:element name="interceptor"
            type="javaee:interceptorType"
            maxOccurs="unbounded"/>
    </xsd:sequence>
    <xsd:attribute name="id"
        type="xsd:ID"/>
</xsd:complexType>

<!-- ***** -->

<xsd:complexType name="interceptorType">
    <xsd:annotation>
        <xsd:documentation>

            The interceptorType element declares information about a single
            interceptor class. It consists of :

            - An optional description.
            - The fully-qualified name of the interceptor class.
            - An optional list of around invoke methods declared on the
            interceptor class and/or its super-classes.
            - An optional list of around timeout methods declared on the
            interceptor class and/or its super-classes.
            - An optional list environment dependencies for the interceptor
            class and/or its super-classes.
            - An optional list of post-activate methods declared on the
            interceptor class and/or its super-classes.
            - An optional list of pre-passivate methods declared on the
            interceptor class and/or its super-classes.

        </xsd:documentation>
    </xsd:annotation>

```

```

</xsd:annotation>
<xsd:sequence>
  <xsd:element name="description"
    type="javaee:descriptionType"
    minOccurs="0"
    maxOccurs="unbounded"/>
  <xsd:element name="interceptor-class"
    type="javaee:fully-qualified-classType"/>
  <xsd:element name="around-invoke"
    type="javaee:around-invokeType"
    minOccurs="0"
    maxOccurs="unbounded"/>
  <xsd:element name="around-timeout"
    type="javaee:around-timeoutType"
    minOccurs="0"
    maxOccurs="unbounded"/>
  <xsd:group ref="javaee:jndiEnvironmentRefsGroup"/>
  <xsd:element name="post-activate"
    type="javaee:lifecycle-callbackType"
    minOccurs="0"
    maxOccurs="unbounded"/>
  <xsd:element name="pre-passivate"
    type="javaee:lifecycle-callbackType"
    minOccurs="0"
    maxOccurs="unbounded"/>
</xsd:sequence>
<xsd:attribute name="id"
  type="xsd:ID"/>
</xsd:complexType>

<!-- ***** -->

<xsd:complexType name="interceptor-bindingType">
  <xsd:annotation>
    <xsd:documentation>
<![CDATA[[
  The interceptor-bindingType element describes the binding of
  interceptor classes to beans within the ejb-jar or .war.
  It consists of :

  - An optional description.
  - The name of an ejb within the module or the wildcard value "*",
  which is used to define interceptors that are bound to all
  beans in the ejb-jar or .war.
  - A list of interceptor classes that are bound to the contents of
  the ejb-name element or a specification of the total ordering
  over the interceptors defined for the given level and above.
  - An optional exclude-default-interceptors element. If set to true,
  specifies that default interceptors are not to be applied to
  a bean-class and/or business method.
  - An optional exclude-class-interceptors element. If set to true,
  specifies that class interceptors are not to be applied to
  a business method.
  - An optional set of method elements for describing the name/params
  of a method-level interceptor.

  Interceptors bound to all classes using the wildcard syntax
  "*" are default interceptors for the components in the ejb-jar or
.war.

  In addition, interceptors may be bound at the level of the bean
  class (class-level interceptors) or business methods (method-level
  interceptors ).

  The binding of interceptors to classes is additive. If interceptors
  are bound at the class-level and/or default-level as well as the

```

method-level, both class-level and/or default-level as well as method-level will apply.

There are four possible styles of the interceptor element syntax :

```
1.
<interceptor-binding>
<ejb-name>*</ejb-name>
<interceptor-class>INTERCEPTOR</interceptor-class>
</interceptor-binding>
```

Specifying the `ejb-name` as the wildcard value "*" designates default interceptors (interceptors that apply to all session and message-driven beans contained in the `ejb-jar` or `.war`).

```
2.
<interceptor-binding>
<ejb-name>EJBNAME</ejb-name>
<interceptor-class>INTERCEPTOR</interceptor-class>
</interceptor-binding>
```

This style is used to refer to interceptors associated with the specified enterprise bean (class-level interceptors).

```
3.
<interceptor-binding>
<ejb-name>EJBNAME</ejb-name>
<interceptor-class>INTERCEPTOR</interceptor-class>
<method>
<method-name>METHOD</method-name>
</method>
</interceptor-binding>
```

This style is used to associate a method-level interceptor with the specified enterprise bean. If there are multiple methods with the same overloaded name, the element of this style refers to all the methods with the overloaded name. Method-level interceptors can only be associated with business methods of the bean class. Note that the wildcard value "*" cannot be used to specify method-level interceptors.

```
4.
<interceptor-binding>
<ejb-name>EJBNAME</ejb-name>
<interceptor-class>INTERCEPTOR</interceptor-class>
<method>
<method-name>METHOD</method-name>
<method-params>
<method-param>PARAM-1</method-param>
<method-param>PARAM-2</method-param>
...
<method-param>PARAM-N</method-param>
</method-params>
</method>
</interceptor-binding>
```

This style is used to associate a method-level interceptor with the specified method of the specified enterprise bean. This style is used to refer to a single method within a set of methods with an overloaded name. The values `PARAM-1` through `PARAM-N` are the fully-qualified Java types of the method's input parameters (if the method has no input arguments, the `method-params` element contains no `method-param` elements). Arrays are specified by the array element's type, followed by one or more pair of square brackets (e.g. `int[][]`).

```

]]>
  </xsd:documentation>
</xsd:annotation>
<xsd:sequence>
  <xsd:element name="description"
    type="javaee:descriptionType"
    minOccurs="0"
    maxOccurs="unbounded"/>
  <xsd:element name="ejb-name"
    type="javaee:string"/>
  <xsd:choice>
    <xsd:element name="interceptor-class"
      type="javaee:fully-qualified-classType"
      minOccurs="0"
      maxOccurs="unbounded"/>
    <xsd:element name="interceptor-order"
      type="javaee:interceptor-orderType"
      minOccurs="1"/>
  </xsd:choice>
  <xsd:element name="exclude-default-interceptors"
    type="javaee:true-falseType"
    minOccurs="0"/>
  <xsd:element name="exclude-class-interceptors"
    type="javaee:true-falseType"
    minOccurs="0"/>
  <xsd:element name="method"
    type="javaee:named-methodType"
    minOccurs="0"/>
</xsd:sequence>
<xsd:attribute name="id"
  type="xsd:ID"/>
</xsd:complexType>

<!-- ***** -->

<xsd:complexType name="interceptor-orderType">
  <xsd:annotation>
    <xsd:documentation>

      The interceptor-orderType element describes a total ordering
      of interceptor classes.

    </xsd:documentation>
  </xsd:annotation>
  <xsd:sequence>
    <xsd:element name="interceptor-class"
      type="javaee:fully-qualified-classType"
      minOccurs="1"
      maxOccurs="unbounded"/>
  </xsd:sequence>
  <xsd:attribute name="id"
    type="xsd:ID"/>
</xsd:complexType>

<!-- ***** -->

<xsd:complexType name="named-methodType">
  <xsd:sequence>
    <xsd:element name="method-name"
      type="javaee:string"/>
    <xsd:element name="method-params"
      type="javaee:method-paramsType"
      minOccurs="0"/>
  </xsd:sequence>

```

```

        <xsd:attribute name="id"
                    type="xsd:ID"/>
    </xsd:complexType>

<!-- ***** -->

    <xsd:complexType name="init-methodType">
        <xsd:sequence>
            <xsd:element name="create-method"
                        type="javaee:named-methodType"/>
            <xsd:element name="bean-method"
                        type="javaee:named-methodType"/>
        </xsd:sequence>
        <xsd:attribute name="id"
                    type="xsd:ID"/>
    </xsd:complexType>

<!-- ***** -->

    <xsd:complexType name="remove-methodType">
        <xsd:sequence>
            <xsd:element name="bean-method"
                        type="javaee:named-methodType"/>
            <xsd:element name="retain-if-exception"
                        type="javaee:true-falseType"
                        minOccurs="0"/>
        </xsd:sequence>
        <xsd:attribute name="id"
                    type="xsd:ID"/>
    </xsd:complexType>

<!-- ***** -->

    <xsd:complexType name="message-driven-beanType">
        <xsd:annotation>
            <xsd:documentation>

                The message-driven element declares a message-driven
                bean. The declaration consists of:

                - an optional description
                - an optional display name
                - an optional icon element that contains a small and a large
                  icon file name.
                - a name assigned to the enterprise bean in
                  the deployment descriptor
                - an optional mapped-name element that can be used to provide
                  vendor-specific deployment information such as the physical
                  jndi-name of destination from which this message-driven bean
                  should consume. This element is not required to be supported
                  by all implementations. Any use of this element is non-portable.
                - the message-driven bean's implementation class
                - an optional declaration of the bean's messaging
                  type
                - an optional declaration of the bean's timeout method for
                  handling programmatically created timers
                - an optional declaration of timers to be automatically created at
                  deployment time
                - the optional message-driven bean's transaction management
                  type. If it is not defined, it is defaulted to Container.
                - an optional declaration of the bean's
                  message-destination-type
                - an optional declaration of the bean's

```

```

message-destination-link
- an optional declaration of the message-driven bean's
activation configuration properties
- an optional list of the message-driven bean class and/or
superclass around-invoke methods.
- an optional list of the message-driven bean class and/or
superclass around-timeout methods.
- an optional declaration of the bean's environment
entries
- an optional declaration of the bean's EJB references
- an optional declaration of the bean's local EJB
references
- an optional declaration of the bean's web service
references
- an optional declaration of the security role
references
- an optional declaration of the security
identity to be used for the execution of the bean's
methods
- an optional declaration of the bean's
resource manager connection factory
references
- an optional declaration of the bean's resource
environment references.
- an optional declaration of the bean's message
destination references

</xsd:documentation>
</xsd:annotation>
<xsd:sequence>
  <xsd:group ref="javaee:descriptionGroup"/>
  <xsd:element name="ejb-name"
    type="javaee:ejb-nameType"/>
  <xsd:element name="mapped-name"
    type="javaee:xsdStringType"
    minOccurs="0"/>
  <xsd:element name="ejb-class"
    type="javaee:ejb-classType"
    minOccurs="0">
    <xsd:annotation>
      <xsd:documentation>

        The ejb-class element specifies the fully qualified name
        of the bean class for this ejb. It is required unless
        there is a component-defining annotation for the same
        ejb-name.

      </xsd:documentation>
    </xsd:annotation>
  </xsd:element>
  <xsd:element name="messaging-type"
    type="javaee:fully-qualified-classType"
    minOccurs="0">
    <xsd:annotation>
      <xsd:documentation>

        The messaging-type element specifies the message
        listener interface of the message-driven bean.

      </xsd:documentation>
    </xsd:annotation>
  </xsd:element>
  <xsd:element name="timeout-method"
    type="javaee:named-methodType"
    minOccurs="0">
    <xsd:annotation>

```

```

    <xsd:documentation>
        The timeout-method element specifies the method that
        will receive callbacks for programmatically
        created timers.
    </xsd:documentation>
</xsd:annotation>
</xsd:element>
<xsd:element name="timer"
    type="javaee:timerType"
    minOccurs="0"
    maxOccurs="unbounded"/>
<xsd:element name="transaction-type"
    type="javaee:transaction-typeType"
    minOccurs="0"/>
<xsd:element name="message-destination-type"
    type="javaee:message-destination-typeType"
    minOccurs="0"/>
<xsd:element name="message-destination-link"
    type="javaee:message-destination-linkType"
    minOccurs="0"/>
<xsd:element name="activation-config"
    type="javaee:activation-configType"
    minOccurs="0"/>
<xsd:element name="around-invoke"
    type="javaee:around-invokeType"
    minOccurs="0"
    maxOccurs="unbounded"/>
<xsd:element name="around-timeout"
    type="javaee:around-timeoutType"
    minOccurs="0"
    maxOccurs="unbounded"/>
<xsd:group ref="javaee:jndiEnvironmentRefsGroup"/>
<xsd:element name="security-role-ref"
    type="javaee:security-role-refType"
    minOccurs="0"
    maxOccurs="unbounded">
</xsd:element>
<xsd:element name="security-identity"
    type="javaee:security-identityType"
    minOccurs="0"/>
</xsd:sequence>
<xsd:attribute name="id"
    type="xsd:ID"/>
</xsd:complexType>

<!-- ***** -->

<xsd:complexType name="methodType">
    <xsd:annotation>
        <xsd:documentation>
<![CDATA[
    The methodType is used to denote a method of an enterprise
    bean's business, home, component, and/or web service endpoint
    interface, or, in the case of a message-driven bean, the
    bean's message listener method, or a set of such
    methods. The ejb-name element must be the name of one of the
    enterprise beans declared in the deployment descriptor; the
    optional method-intf element allows to distinguish between a
    method with the same signature that is multiply defined
    across the business, home, component, and/or web service
    endpoint nterfaces; the method-name element specifies the
    method name; and the optional method-params elements identify
    a single method among multiple methods with an overloaded

```

method name.

There are three possible styles of using `methodType` element within a `method` element:

```
1.
<method>
<ejb-name>EJBNAME</ejb-name>
<method-name>*</method-name>
</method>
```

This style is used to refer to all the methods of the specified enterprise bean's business, home, component, and/or web service endpoint interfaces.

```
2.
<method>
<ejb-name>EJBNAME</ejb-name>
<method-name>METHOD</method-name>
</method>
```

This style is used to refer to the specified method of the specified enterprise bean. If there are multiple methods with the same overloaded name, the element of this style refers to all the methods with the overloaded name.

```
3.
<method>
<ejb-name>EJBNAME</ejb-name>
<method-name>METHOD</method-name>
<method-params>
  <method-param>PARAM-1</method-param>
  <method-param>PARAM-2</method-param>
  ...
  <method-param>PARAM-n</method-param>
</method-params>
</method>
```

This style is used to refer to a single method within a set of methods with an overloaded name. `PARAM-1` through `PARAM-n` are the fully-qualified Java types of the method's input parameters (if the method has no input arguments, the `method-params` element contains no `method-param` elements). Arrays are specified by the array element's type, followed by one or more pair of square brackets (e.g. `int[][]`). If there are multiple methods with the same overloaded name, this style refers to all of the overloaded methods.

Examples:

Style 1: The following method element refers to all the methods of the `EmployeeService` bean's business, home, component, and/or web service endpoint interfaces:

```
<method>
<ejb-name>EmployeeService</ejb-name>
<method-name>*</method-name>
</method>
```

Style 2: The following method element refers to all the create methods of the `EmployeeService` bean's home interface(s).

```
<method>
```



```
<ejb-name>EmployeeService</ejb-name>
<method-name>create</method-name>
</method>
```

Style 3: The following method element refers to the create(String firstName, String LastName) method of the EmployeeService bean's home interface(s).

```
<method>
<ejb-name>EmployeeService</ejb-name>
<method-name>create</method-name>
<method-params>
  <method-param>java.lang.String</method-param>
  <method-param>java.lang.String</method-param>
</method-params>
</method>
```

The following example illustrates a Style 3 element with more complex parameter types. The method foobar(char s, int i, int[] iar, mypackage.MyClass mycl, mypackage.MyClass[][] myclaar) would be specified as:

```
<method>
<ejb-name>EmployeeService</ejb-name>
<method-name>foobar</method-name>
<method-params>
  <method-param>char</method-param>
  <method-param>int</method-param>
  <method-param>int[]</method-param>
  <method-param>mypackage.MyClass</method-param>
  <method-param>mypackage.MyClass[][]</method-param>
</method-params>
</method>
```

The optional method-intf element can be used when it becomes necessary to differentiate between a method that is multiply defined across the enterprise bean's business, home, component, and/or web service endpoint interfaces with the same name and signature. However, if the same method is a method of both the local business interface, and the local component interface, the same attribute applies to the method for both interfaces. Likewise, if the same method is a method of both the remote business interface and the remote component interface, the same attribute applies to the method for both interfaces.

For example, the method element

```
<method>
<ejb-name>EmployeeService</ejb-name>
<method-intf>Remote</method-intf>
<method-name>create</method-name>
<method-params>
  <method-param>java.lang.String</method-param>
  <method-param>java.lang.String</method-param>
</method-params>
</method>
```

can be used to differentiate the create(String, String) method defined in the remote interface from the create(String, String) method defined in the remote home interface, which would be defined as

```
<method>
<ejb-name>EmployeeService</ejb-name>
<method-intf>Home</method-intf>
<method-name>create</method-name>
```

```

<method-params>
  <method-param>java.lang.String</method-param>
  <method-param>java.lang.String</method-param>
</method-params>
</method>

```

and the create method that is defined in the local home interface which would be defined as

```

<method>
<ejb-name>EmployeeService</ejb-name>
<method-intf>LocalHome</method-intf>
<method-name>create</method-name>
<method-params>
  <method-param>java.lang.String</method-param>
  <method-param>java.lang.String</method-param>
</method-params>
</method>

```

The method-intf element can be used with all three Styles of the method element usage. For example, the following method element example could be used to refer to all the methods of the EmployeeService bean's remote home interface and the remote business interface.

```

<method>
<ejb-name>EmployeeService</ejb-name>
<method-intf>Home</method-intf>
<method-name>*</method-name>
</method>

```

```

]]>
  </xsd:documentation>
</xsd:annotation>
<xsd:sequence>
  <xsd:element name="description"
    type="javaee:descriptionType"
    minOccurs="0"
    maxOccurs="unbounded"/>
  <xsd:element name="ejb-name"
    type="javaee:ejb-nameType"/>
  <xsd:element name="method-intf"
    type="javaee:method-intfType"
    minOccurs="0">
  </xsd:element>
  <xsd:element name="method-name"
    type="javaee:method-nameType"/>
  <xsd:element name="method-params"
    type="javaee:method-paramsType"
    minOccurs="0"/>
</xsd:sequence>
<xsd:attribute name="id"
  type="xsd:ID"/>
</xsd:complexType>

```

```
<!-- ***** -->
```

```

<xsd:complexType name="method-intfType">
  <xsd:annotation>
    <xsd:documentation>

```

The method-intf element allows a method element to differentiate between the methods with the same name and signature that are multiply defined across the home and component interfaces (e.g, in both an enterprise bean's

remote and local interfaces or in both an enterprise bean's home and remote interfaces, etc.); the component and web service endpoint interfaces, and so on.

Local applies to the local component interface, local business interfaces, and the no-interface view.

Remote applies to both remote component interface and the remote business interfaces.

ServiceEndpoint refers to methods exposed through a web service endpoint.

Timer refers to the bean's timeout callback methods.

MessageEndpoint refers to the methods of a message-driven bean's message-listener interface.

The method-intf element must be one of the following:

```
Home
Remote
LocalHome
Local
ServiceEndpoint
Timer
MessageEndpoint
```

```
</xsd:documentation>
</xsd:annotation>
<xsd:simpleContent>
  <xsd:restriction base="javaee:string">
    <xsd:enumeration value="Home"/>
    <xsd:enumeration value="Remote"/>
    <xsd:enumeration value="LocalHome"/>
    <xsd:enumeration value="Local"/>
    <xsd:enumeration value="ServiceEndpoint"/>
    <xsd:enumeration value="Timer"/>
    <xsd:enumeration value="MessageEndpoint"/>
  </xsd:restriction>
</xsd:simpleContent>
</xsd:complexType>
```

```
<!-- ***** -->
```

```
<xsd:complexType name="method-nameType">
  <xsd:annotation>
    <xsd:documentation>

      The method-nameType contains a name of an enterprise
      bean method or the asterisk (*) character. The asterisk is
      used when the element denotes all the methods of an
      enterprise bean's client view interfaces.

    </xsd:documentation>
  </xsd:annotation>
  <xsd:simpleContent>
    <xsd:restriction base="javaee:string"/>
  </xsd:simpleContent>
</xsd:complexType>
```

```
<!-- ***** -->
```

```
<xsd:complexType name="method-paramsType">
```

```

<xsd:annotation>
  <xsd:documentation>

    The method-paramsType defines a list of the
    fully-qualified Java type names of the method parameters.

  </xsd:documentation>
</xsd:annotation>
<xsd:sequence>
  <xsd:element name="method-param"
    type="javaee:java-typeType"
    minOccurs="0"
    maxOccurs="unbounded">
    <xsd:annotation>
      <xsd:documentation>

        The method-param element contains a primitive
        or a fully-qualified Java type name of a method
        parameter.

      </xsd:documentation>
    </xsd:annotation>
  </xsd:element>
</xsd:sequence>
<xsd:attribute name="id"
  type="xsd:ID"/>
</xsd:complexType>

<!-- ***** -->

<xsd:complexType name="method-permissionType">
  <xsd:annotation>
    <xsd:documentation>

      The method-permissionType specifies that one or more
      security roles are allowed to invoke one or more enterprise
      bean methods. The method-permissionType consists of an
      optional description, a list of security role names or an
      indicator to state that the method is unchecked for
      authorization, and a list of method elements.

      The security roles used in the method-permissionType
      must be defined in the security-role elements of the
      deployment descriptor, and the methods must be methods
      defined in the enterprise bean's business, home, component
      and/or web service endpoint interfaces.

    </xsd:documentation>
  </xsd:annotation>
  <xsd:sequence>
    <xsd:element name="description"
      type="javaee:descriptionType"
      minOccurs="0"
      maxOccurs="unbounded"/>
    <xsd:choice>
      <xsd:element name="role-name"
        type="javaee:role-nameType"
        maxOccurs="unbounded"/>
      <xsd:element name="unchecked"
        type="javaee:emptyType">
        <xsd:annotation>
          <xsd:documentation>

            The unchecked element specifies that a method is
            not checked for authorization by the container
  
```

```

        prior to invocation of the method.
    </xsd:documentation>
  </xsd:annotation>
</xsd:element>
</xsd:choice>
<xsd:element name="method"
             type="javaee:methodType"
             maxOccurs="unbounded"/>
</xsd:sequence>
<xsd:attribute name="id"
              type="xsd:ID"/>
</xsd:complexType>

<!-- ***** -->

<xsd:complexType name="multiplicityType">
  <xsd:annotation>
    <xsd:documentation>

      The multiplicityType describes the multiplicity of the
      role that participates in a relation.

      The value must be one of the two following:

      One
      Many

    </xsd:documentation>
  </xsd:annotation>
  <xsd:simpleContent>
    <xsd:restriction base="javaee:string">
      <xsd:enumeration value="One"/>
      <xsd:enumeration value="Many"/>
    </xsd:restriction>
  </xsd:simpleContent>
</xsd:complexType>

<!-- ***** -->

<xsd:complexType name="persistence-typeType">
  <xsd:annotation>
    <xsd:documentation>

      The persistence-typeType specifies an entity bean's persistence
      management type.

      The persistence-type element must be one of the two following:

      Bean
      Container

    </xsd:documentation>
  </xsd:annotation>
  <xsd:simpleContent>
    <xsd:restriction base="javaee:string">
      <xsd:enumeration value="Bean"/>
      <xsd:enumeration value="Container"/>
    </xsd:restriction>
  </xsd:simpleContent>
</xsd:complexType>

<!-- ***** -->

```

```

<xsd:complexType name="queryType">
  <xsd:annotation>
    <xsd:documentation>

      The queryType defines a finder or select
      query. It contains
      - an optional description of the query
      - the specification of the finder or select
      method it is used by
      - an optional specification of the result type
      mapping, if the query is for a select method
      and entity objects are returned.
      - the EJB QL query string that defines the query.

      Queries that are expressible in EJB QL must use the ejb-ql
      element to specify the query. If a query is not expressible
      in EJB QL, the description element should be used to
      describe the semantics of the query and the ejb-ql element
      should be empty.

      The result-type-mapping is an optional element. It can only
      be present if the query-method specifies a select method
      that returns entity objects. The default value for the
      result-type-mapping element is "Local".

    </xsd:documentation>
  </xsd:annotation>
  <xsd:sequence>
    <xsd:element name="description"
      type="javaee:descriptionType"
      minOccurs="0"/>
    <xsd:element name="query-method"
      type="javaee:query-methodType"/>
    <xsd:element name="result-type-mapping"
      type="javaee:result-type-mappingType"
      minOccurs="0"/>
    <xsd:element name="ejb-ql"
      type="javaee:xsdStringType"/>
  </xsd:sequence>
  <xsd:attribute name="id"
    type="xsd:ID"/>
</xsd:complexType>

<!-- ***** -->

<xsd:complexType name="query-methodType">
  <xsd:annotation>
    <xsd:documentation>
<![CDATA[[
  The query-method specifies the method for a finder or select
  query.

  The method-name element specifies the name of a finder or select
  method in the entity bean's implementation class.

  Each method-param must be defined for a query-method using the
  method-params element.

  It is used by the query-method element.

  Example:

  <query>
  <description>Method finds large orders</description>

```

```

        <query-method>
          <method-name>findLargeOrders</method-name>
          <method-params></method-params>
        </query-method>
        <ejb-ql>
          SELECT OBJECT(o) FROM Order o
          WHERE o.amount > 1000
        </ejb-ql>
      </query>
    ]]>
      </xsd:documentation>
    </xsd:annotation>
    <xsd:sequence>
      <xsd:element name="method-name"
        type="javaee:methodNameType"/>
      <xsd:element name="method-params"
        type="javaee:methodParamsType"/>
    </xsd:sequence>
    <xsd:attribute name="id"
      type="xsd:ID"/>
  </xsd:complexType>

<!-- ***** -->

  <xsd:complexType name="relationship-role-sourceType">
    <xsd:annotation>
      <xsd:documentation>

        The relationship-role-sourceType designates the source of a
        role that participates in a relationship. A
        relationship-role-sourceType is used by
        relationship-role-source elements to uniquely identify an
        entity bean.

      </xsd:documentation>
    </xsd:annotation>
    <xsd:sequence>
      <xsd:element name="description"
        type="javaee:descriptionType"
        minOccurs="0"
        maxOccurs="unbounded"/>
      <xsd:element name="ejb-name"
        type="javaee:ejbNameType"/>
    </xsd:sequence>
    <xsd:attribute name="id"
      type="xsd:ID"/>
  </xsd:complexType>

<!-- ***** -->

  <xsd:complexType name="relationshipsType">
    <xsd:annotation>
      <xsd:documentation>

        The relationshipsType describes the relationships in
        which entity beans with container-managed persistence
        participate. The relationshipsType contains an optional
        description; and a list of ejb-relation elements, which
        specify the container managed relationships.

      </xsd:documentation>
    </xsd:annotation>
    <xsd:sequence>

```

```

    <xsd:element name="description"
      type="javaee:descriptionType"
      minOccurs="0"
      maxOccurs="unbounded"/>
    <xsd:element name="ejb-relation"
      type="javaee:ejb-relationType"
      maxOccurs="unbounded">
      <xsd:unique name="role-name-uniqueness">
        <xsd:annotation>
          <xsd:documentation>

            The ejb-relationship-role-name contains the name of a
            relationship role. The name must be unique within
            a relationship, but can be reused in different
            relationships.

          </xsd:documentation>
        </xsd:annotation>
        <xsd:selector xpath="//javaee:ejb-relationship-role-name"/>
        <xsd:field xpath="."/>
      </xsd:unique>
    </xsd:element>
  </xsd:sequence>
  <xsd:attribute name="id"
    type="xsd:ID"/>
</xsd:complexType>

<!-- ***** -->

<xsd:complexType name="result-type-mappingType">
  <xsd:annotation>
    <xsd:documentation>

      The result-type-mappingType is used in the query element to
      specify whether an abstract schema type returned by a query
      for a select method is to be mapped to an EJBLocalObject or
      EJBObject type.

      The value must be one of the following:

      Local
      Remote

    </xsd:documentation>
  </xsd:annotation>
  <xsd:simpleContent>
    <xsd:restriction base="javaee:string">
      <xsd:enumeration value="Local"/>
      <xsd:enumeration value="Remote"/>
    </xsd:restriction>
  </xsd:simpleContent>
</xsd:complexType>

<!-- ***** -->

<xsd:complexType name="security-identityType">
  <xsd:annotation>
    <xsd:documentation>

      The security-identityType specifies whether the caller's
      security identity is to be used for the execution of the
      methods of the enterprise bean or whether a specific run-as
      identity is to be used. It contains an optional description
      and a specification of the security identity to be used.
    
```



```

    </xsd:documentation>
  </xsd:annotation>
<xsd:sequence>
  <xsd:element name="description"
    type="javaee:descriptionType"
    minOccurs="0"
    maxOccurs="unbounded"/>
  <xsd:choice>
    <xsd:element name="use-caller-identity"
      type="javaee:emptyType">
      <xsd:annotation>
        <xsd:documentation>

          The use-caller-identity element specifies that
          the caller's security identity be used as the
          security identity for the execution of the
          enterprise bean's methods.

        </xsd:documentation>
      </xsd:annotation>
    </xsd:element>
    <xsd:element name="run-as"
      type="javaee:run-asType"/>
  </xsd:choice>
</xsd:sequence>
<xsd:attribute name="id"
  type="xsd:ID"/>
</xsd:complexType>

<!-- ***** -->

<xsd:complexType name="session-beanType">
  <xsd:annotation>
    <xsd:documentation>

      The session-beanType declares an session bean. The
      declaration consists of:

      - an optional description
      - an optional display name
      - an optional icon element that contains a small and a large
        icon file name
      - a name assigned to the enterprise bean
        in the deployment description
      - an optional mapped-name element that can be used to provide
        vendor-specific deployment information such as the physical
        jndi-name of the session bean's remote home/business interface.
        This element is not required to be supported by all
        implementations. Any use of this element is non-portable.
      - the names of all the remote or local business interfaces,
        if any
      - the names of the session bean's remote home and
        remote interfaces, if any
      - the names of the session bean's local home and
        local interfaces, if any
      - an optional declaration that this bean exposes a
        no-interface view
      - the name of the session bean's web service endpoint
        interface, if any
      - the session bean's implementation class
      - the session bean's state management type
      - an optional declaration of a stateful session bean's timeout value
      - an optional declaration of the session bean's timeout method for
        handling programmatically created timers
    </xsd:documentation>
  </xsd:annotation>
</xsd:complexType>

```

- an optional declaration of timers to be automatically created at deployment time
- an optional declaration that a Singleton bean has eager initialization
- an optional declaration of a Singleton/Stateful bean's concurrency management type
- an optional declaration of the method locking metadata for a Singleton with container managed concurrency
- an optional declaration of the other Singleton beans in the application that must be initialized before this bean
- an optional declaration of the session bean's asynchronous methods
- the optional session bean's transaction management type. If it is not present, it is defaulted to Container.
- an optional declaration of a stateful session bean's afterBegin, beforeCompletion, and/or afterCompletion methods
- an optional list of the session bean class and/or superclass around-invoke methods.
- an optional list of the session bean class and/or superclass around-timeout methods.
- an optional declaration of the bean's environment entries
- an optional declaration of the bean's EJB references
- an optional declaration of the bean's local EJB references
- an optional declaration of the bean's web service references
- an optional declaration of the security role references
- an optional declaration of the security identity to be used for the execution of the bean's methods
- an optional declaration of the bean's resource manager connection factory references
- an optional declaration of the bean's resource environment references.
- an optional declaration of the bean's message destination references

The elements that are optional are "optional" in the sense that they are omitted when if lists represented by them are empty.

The service-endpoint element may only be specified if the bean is a stateless session bean.

```

</xsd:documentation>
</xsd:annotation>
<xsd:sequence>
  <xsd:group ref="javaee:descriptionGroup"/>
  <xsd:element name="ejb-name"
    type="javaee:ejb-nameType"/>
  <xsd:element name="mapped-name"
    type="javaee:xsdStringType"
    minOccurs="0"/>
  <xsd:element name="home"
    type="javaee:homeType"
    minOccurs="0"/>
  <xsd:element name="remote"
    type="javaee:remoteType"
    minOccurs="0"/>
  <xsd:element name="local-home"
    type="javaee:local-homeType"
    minOccurs="0"/>
  <xsd:element name="local"
    type="javaee:localType"
    minOccurs="0"/>

```

```

<xsd:element name="business-local"
  type="javaee:fully-qualified-classType"
  minOccurs="0"
  maxOccurs="unbounded"/>
<xsd:element name="business-remote"
  type="javaee:fully-qualified-classType"
  minOccurs="0"
  maxOccurs="unbounded"/>
<xsd:element name="local-bean"
  type="javaee:emptyType"
  minOccurs="0">
  <xsd:annotation>
    <xsd:documentation>

      The local-bean element declares that this
      session bean exposes a no-interface Local client view.

    </xsd:documentation>
  </xsd:annotation>
</xsd:element>
<xsd:element name="service-endpoint"
  type="javaee:fully-qualified-classType"
  minOccurs="0">
  <xsd:annotation>
    <xsd:documentation>

      The service-endpoint element contains the
      fully-qualified name of the enterprise bean's web
      service endpoint interface. The service-endpoint
      element may only be specified for a stateless
      session bean. The specified interface must be a
      valid JAX-RPC service endpoint interface.

    </xsd:documentation>
  </xsd:annotation>
</xsd:element>
<xsd:element name="ejb-class"
  type="javaee:ejb-classType"
  minOccurs="0">
  <xsd:annotation>
    <xsd:documentation>

      The ejb-class element specifies the fully qualified name
      of the bean class for this ejb. It is required unless
      there is a component-defining annotation for the same
      ejb-name.

    </xsd:documentation>
  </xsd:annotation>
</xsd:element>
<xsd:element name="session-type"
  type="javaee:session-typeType"
  minOccurs="0"/>
<xsd:element name="stateful-timeout"
  type="javaee:stateful-timeoutType"
  minOccurs="0"/>
<xsd:element name="timeout-method"
  type="javaee:named-methodType"
  minOccurs="0">
  <xsd:annotation>
    <xsd:documentation>

      The timeout-method element specifies the method that
      will receive callbacks for programmatically
      created timers.
    
```

```

    </xsd:documentation>
  </xsd:annotation>
</xsd:element>
<xsd:element name="timer"
  type="javaee:timerType"
  minOccurs="0"
  maxOccurs="unbounded"/>
<xsd:element name="init-on-startup"
  type="javaee:true-falseType"
  minOccurs="0">
  <xsd:annotation>
    <xsd:documentation>

      The init-on-startup element specifies that a Singleton
      bean has eager initialization.
      This element can only be specified for singleton session
      beans.

    </xsd:documentation>
  </xsd:annotation>
</xsd:element>
<xsd:element name="concurrency-management-type"
  type="javaee:concurrency-management-typeType"
  minOccurs="0"/>
<xsd:element name="concurrent-method"
  type="javaee:concurrent-methodType"
  minOccurs="0"
  maxOccurs="unbounded"/>
<xsd:element name="depends-on"
  type="javaee:depends-onType"
  minOccurs="0"/>
<xsd:element name="init-method"
  type="javaee:init-methodType"
  minOccurs="0"
  maxOccurs="unbounded">
  <xsd:annotation>
    <xsd:documentation>

      The init-method element specifies the mappings for
      EJB 2.x style create methods for an EJB 3.x bean.
      This element can only be specified for stateful
      session beans.

    </xsd:documentation>
  </xsd:annotation>
</xsd:element>
<xsd:element name="remove-method"
  type="javaee:remove-methodType"
  minOccurs="0"
  maxOccurs="unbounded">
  <xsd:annotation>
    <xsd:documentation>

      The remove-method element specifies the mappings for
      EJB 2.x style remove methods for an EJB 3.x bean.
      This element can only be specified for stateful
      session beans.

    </xsd:documentation>
  </xsd:annotation>
</xsd:element>
<xsd:element name="async-method"
  type="javaee:async-methodType"
  minOccurs="0"
  maxOccurs="unbounded"/>
<xsd:element name="transaction-type"

```

```

        type="javaee:transaction-typeType"
        minOccurs="0"/>
<xsd:element name="after-begin-method"
        type="javaee:named-methodType"
        minOccurs="0"/>
<xsd:element name="before-completion-method"
        type="javaee:named-methodType"
        minOccurs="0"/>
<xsd:element name="after-completion-method"
        type="javaee:named-methodType"
        minOccurs="0"/>
<xsd:element name="around-invoke"
        type="javaee:around-invokeType"
        minOccurs="0"
        maxOccurs="unbounded"/>
<xsd:element name="around-timeout"
        type="javaee:around-timeoutType"
        minOccurs="0"
        maxOccurs="unbounded"/>
<xsd:group ref="javaee:jndiEnvironmentRefsGroup"/>
<xsd:element name="post-activate"
        type="javaee:lifecycle-callbackType"
        minOccurs="0"
        maxOccurs="unbounded"/>
<xsd:element name="pre-passivate"
        type="javaee:lifecycle-callbackType"
        minOccurs="0"
        maxOccurs="unbounded"/>
<xsd:element name="security-role-ref"
        type="javaee:security-role-refType"
        minOccurs="0"
        maxOccurs="unbounded">
</xsd:element>
<xsd:element name="security-identity"
        type="javaee:security-identityType"
        minOccurs="0">
</xsd:element>
</xsd:sequence>
<xsd:attribute name="id"
        type="xsd:ID"/>
</xsd:complexType>

```

```
<!-- ***** -->
```

```

<xsd:complexType name="session-typeType">
  <xsd:annotation>
    <xsd:documentation>

      The session-typeType describes whether the session bean is a
      singleton, stateful or stateless session. It is used by
      session-type elements.

      The value must be one of the three following:

      Singleton
      Stateful
      Stateless

    </xsd:documentation>
  </xsd:annotation>
  <xsd:simpleContent>
    <xsd:restriction base="javaee:string">
      <xsd:enumeration value="Singleton"/>
      <xsd:enumeration value="Stateful"/>
      <xsd:enumeration value="Stateless"/>
    </xsd:restriction>
  </xsd:simpleContent>

```

```

        </xsd:restriction>
    </xsd:simpleContent>
</xsd:complexType>

<!-- ***** -->

<xsd:complexType name="stateful-timeoutType">
  <xsd:annotation>
    <xsd:documentation>

      The stateful-timeoutType represents the amount of time
      a stateful session bean can be idle(not receive any client
      invocations) before it is eligible for removal by the container.

      A timeout value of 0 means the bean is immediately eligible for
      removal.

      A timeout value of -1 means the bean will never be removed due to tim-
      eout.

    </xsd:documentation>
  </xsd:annotation>
  <xsd:sequence>
    <xsd:element name="timeout"
      type="javaee:xsdIntegerType"/>
    <xsd:element name="unit"
      type="javaee:time-unit-typeType"/>
  </xsd:sequence>
  <xsd:attribute name="id"
    type="xsd:ID"/>
</xsd:complexType>

<!-- ***** -->

<xsd:complexType name="time-unit-typeType">
  <xsd:annotation>
    <xsd:documentation>

      The time-unit-typeType represents a time duration at a given
      unit of granularity.

      The time unit type must be one of the following :

      Days
      Hours
      Minutes
      Seconds
      Milliseconds
      Microseconds
      Nanoseconds

    </xsd:documentation>
  </xsd:annotation>
  <xsd:simpleContent>
    <xsd:restriction base="javaee:string">
      <xsd:enumeration value="Days"/>
      <xsd:enumeration value="Hours"/>
      <xsd:enumeration value="Minutes"/>
      <xsd:enumeration value="Seconds"/>
      <xsd:enumeration value="Milliseconds"/>
      <xsd:enumeration value="Microseconds"/>
      <xsd:enumeration value="Nanoseconds"/>
    </xsd:restriction>
  </xsd:simpleContent>

```

```

</xsd:complexType>

<!-- ***** -->

<xsd:complexType name="timer-scheduleType">
  <xsd:sequence>
    <xsd:element name="second"
      type="javaee:string"
      minOccurs="0"/>
    <xsd:element name="minute"
      type="javaee:string"
      minOccurs="0"/>
    <xsd:element name="hour"
      type="javaee:string"
      minOccurs="0"/>
    <xsd:element name="day-of-month"
      type="javaee:string"
      minOccurs="0"/>
    <xsd:element name="month"
      type="javaee:string"
      minOccurs="0"/>
    <xsd:element name="day-of-week"
      type="javaee:string"
      minOccurs="0"/>
    <xsd:element name="year"
      type="javaee:string"
      minOccurs="0"/>
  </xsd:sequence>
  <xsd:attribute name="id"
    type="xsd:ID"/>
</xsd:complexType>

<!-- ***** -->

<xsd:complexType name="timerType">
  <xsd:annotation>
    <xsd:documentation>

      The timerType specifies an enterprise bean timer. Each
      timer is automatically created by the container upon
      deployment. Timer callbacks occur based on the
      schedule attributes. All callbacks are made to the
      timeout-method associated with the timer.

      A timer can have an optional start and/or end date. If
      a start date is specified, it takes precedence over the
      associated timer schedule such that any matching
      expirations prior to the start time will not occur.
      Likewise, no matching expirations will occur after any
      end date. Start/End dates are specified using the
      XML Schema dateTime type, which follows the ISO-8601
      standard for date(and optional time-within-the-day)
      representation.

      An optional flag can be used to control whether
      this timer has persistent(true) delivery semantics or
      non-persistent(false) delivery semantics. If not specified,
      the value defaults to persistent(true).

      A time zone can optionally be associated with a timer.
      If specified, the timer's schedule is evaluated in the context
      of that time zone, regardless of the default time zone in which
      the container is executing. Time zones are specified as an
      ID string. The set of required time zone IDs is defined by

```

the Zone Name(TZ) column of the public domain zoneinfo database.

An optional info string can be assigned to the timer and retrieved at runtime through the Timer.getInfo() method.

The timerType can only be specified on stateless session beans, singleton session beans, and message-driven beans.

```

</xsd:documentation>
</xsd:annotation>
<xsd:sequence>
  <xsd:element name="description"
    type="javaee:descriptionType"
    minOccurs="0"
    maxOccurs="unbounded"/>
  <xsd:element name="schedule"
    type="javaee:timer-scheduleType"/>
  <xsd:element name="start"
    type="xsd:dateTime"
    minOccurs="0"/>
  <xsd:element name="end"
    type="xsd:dateTime"
    minOccurs="0"/>
  <xsd:element name="timeout-method"
    type="javaee:named-methodType"/>
  <xsd:element name="persistent"
    type="javaee:true-falseType"
    minOccurs="0"/>
  <xsd:element name="timezone"
    type="javaee:string"
    minOccurs="0"/>
  <xsd:element name="info"
    type="javaee:string"
    minOccurs="0"/>
</xsd:sequence>
<xsd:attribute name="id"
  type="xsd:ID"/>
</xsd:complexType>

<!-- ***** -->

<xsd:complexType name="trans-attributeType">
  <xsd:annotation>
    <xsd:documentation>

      The trans-attributeType specifies how the container must
      manage the transaction boundaries when delegating a method
      invocation to an enterprise bean's business method.

      The value must be one of the following:

      NotSupported
      Supports
      Required
      RequiresNew
      Mandatory
      Never

    </xsd:documentation>
  </xsd:annotation>
  <xsd:simpleContent>
    <xsd:restriction base="javaee:string">
      <xsd:enumeration value="NotSupported"/>
      <xsd:enumeration value="Supports"/>
      <xsd:enumeration value="Required"/>
    </xsd:restriction>
  </xsd:simpleContent>
</xsd:complexType>

```



```
        <xsd:enumeration value="RequiresNew"/>
        <xsd:enumeration value="Mandatory"/>
        <xsd:enumeration value="Never"/>
    </xsd:restriction>
</xsd:simpleContent>
</xsd:complexType>

<!-- ***** -->

<xsd:complexType name="transaction-typeType">
  <xsd:annotation>
    <xsd:documentation>

      The transaction-typeType specifies an enterprise bean's
      transaction management type.

      The transaction-type must be one of the two following:

      Bean
      Container

    </xsd:documentation>
  </xsd:annotation>
  <xsd:simpleContent>
    <xsd:restriction base="javaee:string">
      <xsd:enumeration value="Bean"/>
      <xsd:enumeration value="Container"/>
    </xsd:restriction>
  </xsd:simpleContent>
</xsd:complexType>

</xsd:schema>
```

Packaging

The `ejb-jar` file is the standard format for the exclusive packaging of enterprise beans. Enterprise beans can also be packaged within a web application module (`.war`). The `ejb-jar` file or `.war` file format is used to package un-assembled enterprise beans (the Bean Provider's output), and to package assembled applications (the Application Assembler's output).

20.1 Overview

An `ejb-jar` file is a Java EE module specifically designed for the exclusive packaging of enterprise beans. Enterprise beans can also be packaged within a web application module (`.war`).

The `ejb-jar` file and `.war` file formats serve as the contract between the Bean Provider and the Application Assembler, and between the Application Assembler and the Deployer.

An `ejb-jar` file produced by the Bean Provider contains one or more enterprise beans that typically do not contain application assembly instructions. The `ejb-jar` file produced by an Application Assembler (which can be the same person or organization as the Bean Provider) contains one or more enterprise beans, plus application assembly information describing how the enterprise beans are combined into a single application deployment unit.

A `.war` file is not required to contain any enterprise beans. A `.war` file produced by a Bean Provider contains one or more enterprise beans that typically do not contain application assembly instructions. A `.war` file produced by an Application Assembler (which can be the same person or organization as the Bean Provider) contains one or more enterprise beans, plus application assembly information describing how the enterprise beans are combined into a single application deployment unit.

20.2 Deployment Descriptor

The EJB deployment descriptor is optional for both an `ejb-jar` file and a `.war` file. If a deployment descriptor is provided it must conform to the format defined in Chapter 19.

In an `ejb-jar` file, the deployment descriptor is stored with the name `META-INF/ejb-jar.xml`.

In a `.war` file, the deployment descriptor is stored with the name `WEB-INF/ejb-jar.xml`.

20.3 Packaging Requirements

The `ejb-jar` file or `.war` file must contain, either by inclusion or by reference, the class files of each enterprise bean as follows:

- The enterprise bean class.
- The enterprise bean business interfaces, web service endpoint interfaces, and home and component interfaces.
- Interceptor classes.
- The primary key class if the bean is an entity bean.

We say that a `.jar` file contains a second file “by reference” if the second file is named in the `Class-Path` attribute in the `Manifest` file of the referencing `.jar` file or is contained (either by inclusion or by reference) in another `.jar` file that is named in the `Class-Path` attribute in the `Manifest` file of the referencing `.jar` file.

The `ejb-jar` file or `.war` file must also contain, either by inclusion or by reference, the class files for all the classes and interfaces that each enterprise bean class and the home interfaces, component interfaces, and/or web service endpoints depend on, except Java EE and Java SE classes. This includes their superclasses and superinterfaces, dependent classes, and the classes and interfaces used as method parameters, results, and exceptions.

The Application Assembler must not package the stubs of the `EJBHome` and `EJBObject` interfaces in the `ejb-jar` file or `.war` file. This includes the stubs for the enterprise beans whose implementations are provided in the `ejb-jar` file or `.war` file as well as the referenced enterprise beans. Generating the stubs is the responsibility of the container. The stubs are typically generated by the Container Provider's deployment tools for each class that extends the `EJBHome` or `EJBObject` interfaces, or they may be generated by the container at runtime.

20.4 Enterprise Beans Packaged in a .war

An enterprise bean class with a component-defining annotation defines an enterprise bean component when packaged within the `WEB-INF/classes` directory or in a `.jar` file within `WEB-INF/lib`. An enterprise bean can also be defined via `WEB-INF/ejb-jar.xml`.

A `.war` may contain an `ejb-jar.xml` file. If present, the `ejb-jar.xml` is packaged as `WEB-INF/ejb-jar.xml`. If an `ejb-jar.xml` is present, it applies to all enterprise beans defined by the `.war` file.^[103]

A `.jar` file in `WEB-INF/lib` that contains enterprise beans is *not* considered an independent Java EE "module" in the way that a `.war` file, stand-alone `ejb-jar` file, or an `.ear`-level `ejb-jar` file is considered a module. Such a `.jar` does not define its own module name or its own namespace for `ejb-names`, environment dependencies, persistence units, etc. All such namespaces are scoped to the enclosing `.war` file. In that sense, the packaging of enterprise bean classes in a `WEB-INF/lib.jar` is merely a convenience. It is semantically equivalent to packaging the classes within `WEB-INF/classes`.

20.4.1 Class Loading

Enterprise beans (and any related classes) packaged in a `.war` file have the same class loading requirements as other non-enterprise bean classes packaged in a `.war` file. This means, for example, that a servlet packaged within a `.war` file is guaranteed to have visibility to an enterprise bean component packaged within the same `.war` file, and vice versa. Detailed class loading requirements for web modules are covered in the Java EE Platform specification [12].

20.4.2 Component Environment

In a `.war` file, there is a single component naming environment shared between all the components (web, enterprise bean, etc.) defined by the module. Each enterprise bean defined by the `.war` file shares this single component environment namespace with all other enterprise beans defined by the `.war` file and with all other web components defined by the `.war` file.

[103]Packaging of an `ejb-jar.xml` file anywhere else in the `.war` is not portable and may result in a deployment error.

The Bean Developer should be aware of this name scoping behavior when selecting names of environment dependencies for enterprise beans packaged within a .war file. Unlike enterprise beans packaged in an ejb-jar file *outside* a .war, names of environment entries defined by an enterprise bean inside a .war can clash with names defined by other components. Likewise, enterprise beans packaged in a .war file have visibility to all environment entries defined by any other components in the .war file, including any entries defined within web.xml. This is also true of the advanced case that the ejb-jar.xml file is used to define multiple bean components based on the same bean class. Extra caution should be used when configuring environment dependencies for such bean components.

20.4.3 Visibility of the Local Client View

The local client view(including the no-interface view) of an enterprise bean component defined within a .war file is only required to be accessible to components within the same .war file. Applications needing access to the local client view of an enterprise bean from a *different* module in the same application should use an ejb-jar file to define the enterprise bean that exposes the local client view.

20.4.4 Ejb-names

A .war file has a single namespace for the ejb-names of any enterprise beans it defines. This one ejb-name namespace applies to all enterprise beans defined by the .war, regardless of where in the .war file the enterprise beans are defined and regardless of whether they are defined via ejb-jar.xml or by annotation.

20.4.5 EJB 2.1/1.1 Entity Bean Restriction

EJB 2.1 Entity Beans and EJB 1.1 Entity Beans are not supported within .war files. These component types must only be packaged in a stand-alone ejb-jar file or an ejb-jar file packaged within an .ear file.

20.4.6 JAX-RPC Endpoint Restriction

JAX-RPC based web service endpoints are not supported within .war files. These endpoints must be only be packaged in a stand-alone ejb-jar file or an ejb-jar file packaged within an .ear file.

20.4.7 Example

Here is a simple stateless session bean with a component-defining annotation and a no-interface view :

```
package com.acme;

@Stateless
public class FooBean {
    public void foo() { ... }
}
```

FooBean is packaged in a `.war` file under a `WEB-INF/classes` subdirectory corresponding to its package name. The `.war` file also contains a `Servlet`.

```
webejb.war:
  WEB-INF/classes/com/acme/FooServlet.class
  WEB-INF/classes/com/acme/FooBean.class
```

20.5 Deployment Descriptor and Annotation Processing

The following sections describe the cases that the deployment tool must consider when deciding whether to process annotations on the enterprise bean classes in a module.

20.5.1 Ejb-jar Deployment Descriptor and Annotation Processing

Table 25 describes the requirements for determining when to process annotations on the classes in an `ejb-jar`. If the deployment descriptor is not included or is included but not marked `metadata-complete`, the deployment tool will process annotations.

Table 25 Ejb-jar Annotation Processing Requirements

Deployment Descriptor	metadata-complete?	process annotations?
ejb-jar_2_1 or earlier	N/A	No
ejb-jar_3_x	Yes	No
ejb-jar_3_x	No	Yes
none	N/A	Yes

20.5.2 .war Deployment Descriptor and Annotation Processing

Table 26 describes the requirements for determining when to process annotations on the enterprise bean classes of a `.war`. If the `.war` contains an `ejb-jar.xml` file the deployment tool will process annotations unless the `ejb-jar.xml` has been marked `metadata-complete`. If the `.war` does not contain an `ejb-jar.xml` file, the deployment tool will process annotations unless the `web.xml` is marked `metadata-complete` or its version is prior to `web-app_2_5`.

Table 26 .war Annotation Processing Requirements for enterprise beans

ejb-jar.xml	ejb-jar.xml metadata-complete?	web.xml	web.xml metadata-complete?	process annotations?
ejb-jar_3_x	Yes	N/A	N/A	No
ejb-jar_3_x	No	N/A	N/A	Yes
none	N/A	web-app_3_0 or web-app_2_5	Yes	No
none	N/A	web-app_3_0 or web-app_2_5	No	Yes
none	N/A	web-app_2_4 or earlier	N/A	No
none	N/A	none	N/A	Yes

20.6 The Client View and the ejb-client JAR File

The client view of an enterprise bean is comprised of the business interfaces or home and component interfaces of the referenced enterprise bean and other classes that these interfaces depend on, such as their superclasses and superinterfaces, the classes and interfaces used as method parameters, results, and exceptions. The serializable application value classes, including the classes which may be used as members of a collection in a remote method call to an enterprise bean, are part of the client view. An example of an application value class might be an `Address` class used as a parameter in a method call.

The `ejb-jar` file or `.war` file producer can create an `ejb-client` JAR file. The `ejb-client` JAR file contains all the class files that a client program needs to use the client view of the enterprise beans that are contained in the `ejb-jar` file or `.war` file. If this option is used, it is the responsibility of the Application Assembler to include all the classes necessary to comprise the client view of an enterprise bean in the `ejb-client` JAR file.

The `ejb-client` JAR file is specified in the deployment descriptor of the `ejb-jar` file or `.war` file using the optional `ejb-client-jar` element. The value of the `ejb-client-jar` element is the path name specifying the location of the `ejb-client` JAR file in the containing Java EE Enterprise Application Archive (`.ear`) file. The path name is relative to the location of the referencing `ejb-jar` file or `.war` file.

The EJB specification does not specify whether an `ejb-jar` file or `.war` file should include by copy or by reference the classes that are in an `ejb-client` JAR file, but they must be included either one way or the other. If the by-copy approach is used, the producer simply includes all the class files in the `ejb-client` JAR file also in the `ejb-jar` file or `.war` file. If the by-reference approach is used, the `ejb-jar` file or `.war` file producer does not duplicate the content of the `ejb-client` JAR file in the `ejb-jar` file or `.war` file, but instead uses a Manifest Class-Path entry in the `ejb-jar` file or `.war` file to specify that the `ejb-jar` file or `.war` file depends on the `ejb-client` JAR at runtime. The use of the Class-Path entries in JAR files and `.war` files is explained in the Java EE Platform specification [12].

20.7 Requirements for Clients

The Application Assembler must construct the application to insure that the client view classes are available to the client at runtime. The client of an enterprise bean may be another enterprise bean packaged in the same `ejb-jar` or different `ejb-jar` file, another enterprise bean packaged in the same `.war` file or different `.war` file, or the client may be another Java EE component, such as a web component.

When clients packaged in `.jar` files refer to enterprise beans, the `.jar` file that contains the client, e.g. an `ejb-jar` file, should contain, either by inclusion or by reference, all the client view classes of the referenced beans. The client view classes may have been packaged in an `ejb-client` JAR file. In other words, the `.jar` file that contains the client should contain one of the following:

- a reference to the `ejb-client` JAR file
- a reference to the `ejb-jar` file that contains the client view classes
- a copy of the client view classes

The client may also require the use of system value classes (e.g., the serializable value classes implementing the `javax.ejb.Handle`, `javax.ejb.HomeHandle`, `javax.ejb.EJBMetaData`, `java.util.Enumeration`, `java.util.Collection`, and `java.util.Iterator` interfaces), although these are not packaged with the application. It is the responsibility of the provider of the container hosting the referenced beans to provide the system value classes and make them available for use when the client is deployed. See Section 15.5.5, “System Value Classes”.

20.8 Example

In this example, the Bean Provider has chosen to package the enterprise bean client view classes in a separate `.jar` file and to reference that `.jar` file from the other `.jar` files that need those classes. Those classes are needed both by `ejb2.jar`, packaged in the same application as `ejb1.jar`, and by `ejb3.jar`, packaged in a different application. Those classes are also needed by `ejb1.jar` itself because they define the remote interface of the enterprise beans in `ejb1.jar`, and the Bean Provider has chosen the *by reference* approach to making these classes available.

The deployment descriptor for `ejb1.jar` names the client view jar file in the `ejb-client-jar` element. Because `ejb2.jar` requires these client view classes, it includes a Class-Path reference to `ejb1_client.jar`.

The Class-Path mechanism must be used by components in `app2.ear` to reference the client view jar file that corresponds to the enterprise beans packaged in `ejb1.jar` of `app1.ear`. Those enterprise beans are referenced by enterprise beans in `ejb3.jar`. Note that the client view jar file must be included directly in the `app2.ear` file.

```
app1.ear:
  META-INF/application.xml
  ejb1.jar      Class-Path: ejb1_client.jar
               deployment descriptor contains:
               <ejb-client-jar>ejb1_client.jar</ejb-client-jar>
  ejb1_client.jar
  ejb2.jar      Class-Path: ejb1_client.jar

app2.ear:
  META-INF/application.xml
  ejb1_client.jar
  ejb3.jar      Class-Path: ejb1_client.jar
```

Runtime Environment

This chapter defines the application programming interfaces (APIs) that a compliant EJB 3.1 container must make available to the enterprise bean instances at runtime. These APIs can be used by portable enterprise beans because the APIs are guaranteed to be available in all EJB 3.1 containers.

The set of required APIs is divided into two categories : a *complete* set and a *minimum* set. The minimum set is also referred to as “EJB 3.1 Lite.” This reflects the ability of Server Providers to provide an EJB 3.1 container within a product that implements the Full Java EE Platform or within a subset profile such as the Java EE Web Profile. The *complete* set is required within an implementation of the Full Java EE Platform. The *minimum* set must be supported within an implementation of a *subset* of the Full Java EE Platform. Overall profile requirements are described within the Java EE Platform specification [12].

The chapter also defines the restrictions that the EJB 3.1 Container Provider can impose on the functionality that it provides to the enterprise beans. These restrictions are necessary to enforce security and to allow the container to properly manage the runtime environment.

21.1 EJB 3.1 Lite

The EJB API is comprised of a large feature set with support for implementing business logic in a wide variety of enterprise applications. However, the full range of API contracts is not always crucial for all runtime environments. In addition, the breadth of the full API can present challenges for developers just getting started with Enterprise JavaBeans technology.

For these reasons this specification defines a minimal subset of the EJB API known as EJB 3.1 Lite. EJB 3.1 Lite is *not a product*. Rather, it is a proper subset of the full EJB 3.1 API that includes a small, powerful selection of EJB features suitable for writing portable transactional business logic. The definition of EJB 3.1 Lite gives vendors an option to implement only a portable subset of the EJB API within their product. The vastly reduced size of the feature set makes it suitable for inclusion in a wider range of Java products, many of which have much smaller installation and runtime footprints than a typical full Java EE implementation.

An EJB 3.1 Lite application is merely an EJB application whose EJB API usage falls within the EJB Lite subset. There are no special APIs defined only for EJB 3.1 Lite. Therefore, any EJB 3.1 Lite application can be deployed on any Java EE product that implements Enterprise JavaBeans technology, whether that product supports EJB 3.1 Lite or the full EJB API.

As detailed in Table 27, the EJB 3.1 Lite API is composed of the following subset of the EJB API :

- Stateless, Stateful, and Singleton Session Bean components
 - Local and no-interface view only
 - Synchronous method invocations only
- Container-managed transactions / Bean-managed transactions
- Declarative and programmatic Security
- Interceptors
- Deployment Descriptor support (ejb-jar.xml)

Table 27 Required contents of EJB 3.1 Lite and Full EJB 3.1 API

	EJB 3.1 Lite	Full EJB 3.1 API
<u>COMPONENTS</u>		
Session beans (stateful, stateless, singleton)	YES	YES
Message-driven Beans	NO	YES
2.x/1.x CMP/BMP Entity Beans	NO	YES [Note A]

	<u>EJB 3.1 Lite</u>	<u>Full EJB 3.1 API</u>
Java Persistence 2.0	YES	YES
<u>SESSION BEAN CLIENT VIEWS</u>		
Local / No-interface	YES	YES
3.0 Remote	NO	YES
2.x Remote Home/Component	NO	YES
JAX-WS Web Service Endpoint	NO	YES
JAX-RPC Web Service Endpoint	NO	YES [Note B]
<u>SERVICES</u>		
EJB Timer Service	NO	YES
Asynchronous session bean invocations	NO	YES
Interceptors	YES	YES
RMI-IIOP Interoperability	NO	YES
Container-managed transactions / Bean-managed transactions	YES	YES
Declarative and Programmatic Security	YES	YES
<u>MISC</u>		
Embeddable API	YES	YES[Note C]

Notes:

- [A] Identified as a pruning candidate. See Section 2.7
- [B] Identified as a pruning candidate. See Section 2.7
- [C] In a product implementing the Full EJB 3.1 API, the embeddable API container is only required to support EJB 3.1 Lite.

21.2 Bean Provider's Responsibilities

This section describes the view and responsibilities of the Bean Provider.

21.2.1 APIs Provided by Container

The requirements on APIs provided by the Container are determined by the associated profile specification, e.g. the Java EE 6 specification[12] or the Web Profile Specification.

21.2.2 Programming Restrictions

This section describes the programming restrictions that a Bean Provider must follow to ensure that the enterprise bean is *portable* and can be deployed in any compliant EJB 3.1 container. The restrictions apply to the implementation of the business methods. Section 21.3, which describes the container's view of these restrictions, defines the programming environment that all EJB containers must provide.

- An enterprise bean must not use read/write static fields. Using read-only static fields is allowed. Therefore, it is recommended that all static fields in the enterprise bean class be declared as `final`.

This rule is required to ensure consistent runtime semantics because while some EJB containers may use a single JVM to execute all enterprise bean's instances, others may distribute the instances across multiple JVMs.

- An enterprise bean must not use thread synchronization primitives to synchronize execution of multiple instances, except if it is a Singleton session bean with bean-managed concurrency.

This is for the same reason as above. Synchronization would not work if the EJB container distributed enterprise bean's instances across multiple JVMs.

- An enterprise bean must not use the AWT functionality to attempt to output information to a display, or to input information from a keyboard.

Most servers do not allow direct interaction between an application program and a keyboard/display attached to the server system.

- An enterprise bean must not use the `java.io` package to attempt to access files and directories in the file system.

The file system APIs are not well-suited for business components to access data. Business components should use a resource manager API, such as JDBC, to store data.

- An enterprise bean must not attempt to listen on a socket, accept connections on a socket, or use a socket for multicast.

The EJB architecture allows an enterprise bean instance to be a network socket client, but it does not allow it to be a network server. Allowing the instance to become a network server would conflict with the basic function of the enterprise bean— to serve the EJB clients.

- The enterprise bean must not attempt to query a class to obtain information about the declared members that are not otherwise accessible to the enterprise bean because of the security rules of the Java language. The enterprise bean must not attempt to use the Reflection API to access information that the security rules of the Java programming language make unavailable.

Allowing the enterprise bean to access information about other classes and to access the classes in a manner that is normally disallowed by the Java programming language could compromise security.

- The enterprise bean must not attempt to create a class loader; obtain the current class loader; set the context class loader; set security manager; create a new security manager; stop the JVM; or change the input, output, and error streams.

These functions are reserved for the EJB container. Allowing the enterprise bean to use these functions could compromise security and decrease the container's ability to properly manage the runtime environment.

- The enterprise bean must not attempt to set the socket factory used by `ServerSocket`, `Socket`, or the stream handler factory used by `URL`.

These networking functions are reserved for the EJB container. Allowing the enterprise bean to use these functions could compromise security and decrease the container's ability to properly manage the runtime environment.

- The enterprise bean must not attempt to manage threads. The enterprise bean must not attempt to start, stop, suspend, or resume a thread, or to change a thread's priority or name. The enterprise bean must not attempt to manage thread groups.

These functions are reserved for the EJB container. Allowing the enterprise bean to manage threads would decrease the container's ability to properly manage the runtime environment.

- The enterprise bean must not attempt to directly read or write a file descriptor.

Allowing the enterprise bean to read and write file descriptors directly could compromise security.

- The enterprise bean must not attempt to obtain the security policy information for a particular code source.

Allowing the enterprise bean to access the security policy information would create a security hole.

- The enterprise bean must not attempt to load a native library.

This function is reserved for the EJB container. Allowing the enterprise bean to load native code would create a security hole.

- The enterprise bean must not attempt to gain access to packages and classes that the usual rules of the Java programming language make unavailable to the enterprise bean.

This function is reserved for the EJB container. Allowing the enterprise bean to perform this function would create a security hole.

- The enterprise bean must not attempt to define a class in a package.

This function is reserved for the EJB container. Allowing the enterprise bean to perform this function would create a security hole.

- The enterprise bean must not attempt to access or modify the security configuration objects (Policy, Security, Provider, Signer, and Identity).

These functions are reserved for the EJB container. Allowing the enterprise bean to use these functions could compromise security.

- The enterprise bean must not attempt to use the subclass and object substitution features of the Java Serialization Protocol.

Allowing the enterprise bean to use these functions could compromise security.

- The enterprise bean must not attempt to pass this as an argument or method result. The enterprise bean must pass the result of `SessionContext.getBusinessObject`, `SessionContext.getEJBObject`, `SessionContext.getEJBLocalObject`, `EntityContext.getEJBObject`, or `EntityContext.getEJBLocalObject` instead.

To guarantee portability of the enterprise bean's implementation across all compliant EJB 3.1 containers, the Bean Provider should test the enterprise bean using a container with the security settings defined in Table 28. That table defines the minimal functionality that a compliant EJB container must provide to the enterprise bean instances at runtime.

21.3 Container Provider's Responsibility

This section defines the container's responsibilities for providing the runtime environment to the enterprise bean instances. The requirements described here are considered to be the minimal requirements; a container may choose to provide additional functionality that is not required by the EJB specification.

The following subsections describes the requirements in more detail.

The following table defines the Java 2 platform security permissions that the EJB container must be able to grant to the enterprise bean instances at runtime. The term “grant” means that the container must be able to grant the permission, the term “deny” means that the container should deny the permission.

Table 28 Java 2 Platform Security Policy for a Standard EJB Container

Permission name	EJB Container policy
java.security.AllPermission	deny
java.awt.AWTPermission	deny
java.io.FilePermission	deny
java.net.NetPermission	deny
java.util.PropertyPermission	grant “read”, “*” deny all other
java.lang.reflect.ReflectPermission	deny
java.lang.RuntimePermission	grant “queuePrintJob”, deny all other
java.lang.SecurityPermission	deny
java.io.SerializablePermission	deny
java.net.SocketPermission	grant “connect”, “*” [Note A], deny all other

Notes:

[A] This permission is necessary, for example, to allow enterprise beans to use the client functionality of the Java IDL and RMI-IIOP packages that are part of the Java 2 platform.

Some containers may allow the Deployer to grant more, or fewer, permissions to the enterprise bean instances than specified in Table 28. Support for this is not required by the EJB specification. Enterprise beans that rely on more or fewer permissions will not be portable across all EJB containers.

21.3.1 EJB 3.1 Requirements

The container must implement the EJB 3.1 interfaces as defined in this specification.

The container must implement the semantics of the metadata annotations that are supported by EJB 3.1 as defined by this specification.

21.3.2 JNDI Requirements

At the minimum, the EJB container must provide a JNDI API name space to the enterprise bean instances. The EJB container must make the name space available to an instance when the instance invokes the `javax.naming.InitialContext` default (no-arg) constructor.

All EJB containers must make available at least the following objects in the name space:

- The local business interfaces of other enterprise beans.
- References to the no-interface view of other enterprise beans.
- UserTransaction objects
- EJBContext objects
- The resource factories used by the enterprise beans.
- The entity managers and entity manager factories used by the enterprise beans.

An EJB 3.1 container within an implementation of the Full Java EE Platform must make available the following objects in the name space:

- The remote business interfaces of other enterprise beans.
- The web service interfaces used by the enterprise beans.
- The home interfaces of other enterprise beans.
- ORB objects
- TimerService objects

All enterprise beans deployed within the same .war are presented with the same JNDI name space. In addition, all the instances of the same enterprise bean deployed within an ejb-jar must be presented with the same JNDI API name space.

21.3.3 JTA 1.1 Requirements

The EJB container must include the JTA 1.1 extension, and it must provide the `javax.transaction.UserTransaction` interface to enterprise beans with bean-managed transaction demarcation through the `javax.ejb.EJBContext` interface, and also in JNDI under the name `java:comp/UserTransaction`, in the cases required by the EJB specification.

The other JTA interfaces are low-level transaction manager and resource manager integration interfaces, and are not intended for direct use by enterprise beans.

21.3.4 JDBC™ 3.0 Extension Requirements

The EJB container must include the JDBC 3.0 extension and provide its functionality to the enterprise bean instances, with the exception of the low-level XA and connection pooling interfaces. These low-level interfaces are intended for integration of a JDBC driver with an application server, not for direct use by enterprise beans.

21.3.5 JMS 1.1 Requirements

An implementation requiring the full EJB 3.1 API must include the JMS 1.1 extension and provide its functionality to the enterprise bean instances, with the exception of the low-level interfaces that are intended for integration of a JMS provider with an application server, not for direct use by enterprise beans. These interfaces include: `javax.jms.ServerSession`, `javax.jms.ServerSessionPool`, `javax.jms.ConnectionConsumer`, and all the `javax.jms.XA` interfaces.

In addition, the following methods are for use by the container only. Enterprise beans must not call these methods: `javax.jms.Session.setMessageListener`, `javax.jms.Session.getMessageListener`, `javax.jms.Session.run`, `javax.jms.QueueConnection.createConnectionConsumer`, `javax.jms.TopicConnection.createConnectionConsumer`, `javax.jms.TopicConnection.createDurableConnectionConsumer`, `javax.jms.Connection.createConnectionConsumer`, `javax.jms.Connection.createDurableConnectionConsumer`.

The following methods must not be called by enterprise beans because they may interfere with the connection management by the container: `javax.jms.Connection.setExceptionHandler`, `javax.jms.Connection.stop`, `javax.jms.Connection.setClientID`.

Enterprise beans must not call the `javax.jms.MessageConsumer.setMessageListener` or `javax.jms.MessageConsumer.getMessageListener` method.

This specification recommends, but does not require, that the container throw the `javax.jms.JMSEException` if enterprise beans call any of the methods listed in this section.

21.3.6 Argument Passing Semantics

An enterprise bean's remote business interfaces and/or remote home and remote interfaces are *remote interfaces* for Java RMI. The container must ensure the semantics for passing arguments conforms to Java RMI-IIOP. Non-remote objects must be passed by value.

Specifically, the EJB container is not allowed to pass non-remote objects by reference on inter-EJB invocations when the calling and called enterprise beans are collocated in the same JVM. Doing so could result in the multiple beans sharing the state of a Java object, which would break the enterprise bean's semantics. Any local optimizations of remote interface calls must ensure the semantics for passing arguments conforms to Java RMI-IIOP.

An enterprise bean's local business interfaces and/or local home and local interfaces are *local Java interfaces*. The caller and callee enterprise beans that make use of these local interfaces are typically collocated in the same JVM. The EJB container must ensure the semantics for passing arguments across these interfaces conforms to the standard argument passing semantics of the Java programming language.

21.3.7 Other Requirements

The assertions contained in the Javadoc specification of the EJB interfaces are required functionality and must be implemented by compliant containers.

21.4 Compatibility and Migration

This chapter addresses issues of compatibility and migration between EJB3.1 and earlier components and clients.

21.4.1 Support for Existing Applications

Existing EJB 3.0 and earlier applications must be supported to run unchanged in EJB 3.1 containers. All EJB 3.1 implementations must support EJB 1.1, EJB 2.0, EJB 2.1, and EJB 3.0 deployment descriptors for applications written to earlier versions of the Enterprise JavaBeans specification.

21.4.2 Default Stateful Session Bean Concurrency Behavior

Prior versions of the EJB specification allowed the container to choose the default behavior in the event of concurrent access attempts to a stateful session bean instance. This specification requires a default of serialized requests in the face of concurrency. This means by default clients will not receive the `javax.ejb.ConcurrentAccessException` when concurrent access occurs for a request. This should have minimal impact to correctly written applications since even with the prior behavior there was no guarantee of receiving such an exception due to the inherent race conditions. Applications wishing to receive an exception in the face of concurrency can request that behavior through newly defined metadata. See Section 4.3.14 for more details.

21.4.3 Default Application Exception Subclassing Behavior

The EJB 3.0 Specification was ambiguous with respect to whether the designation of an unchecked exception as an application exception applied to that exception's subclasses. This specification clarifies that by default the application exception designation is inherited by subclasses. Non-inheriting behavior may be specified via new metadata on `@ApplicationException` and in the deployment descriptor. See Section 14.1.1 for more details.

21.4.4 Interoperability of EJB 3.1 and Earlier Components

This release of Enterprise JavaBeans supports migration and interoperability among client and server components written to different versions of the EJB APIs as described below.

21.4.4.1 Clients written to the EJB 2.x APIs

An enterprise bean that is written to the EJB 2.1 or earlier API release may be a client of components written to the EJB 3.x API using the earlier EJB APIs when deployed in an EJB 3.1 container.

Such an EJB 2.1 or earlier client component does not need to be rewritten or recompiled to be a client of a component written to the EJB 3.x API.

Such clients may access components written to the EJB 3.x APIs and components written to the earlier EJB APIs within the same transaction.

See Section 21.4.5 for a discussion of the mechanisms that are used to enable components written to the EJB 3.x API to be accessed and utilized by clients written to earlier versions of the EJB specification.

21.4.4.2 Clients written to the EJB 3.x API

A client written to the JB 3.x API may be a client of a component written to the EJB 2.1 or earlier API.

Such clients may access components written to the EJB 3.x APIs and components written to the earlier EJB APIs within the same transaction.

Such clients access components written to the earlier EJB APIs using the EJB 2.1 client view home and component interfaces. The `EJB` annotation (or the `ejb-ref` and `ejb-local-ref` deployment descriptor elements) may be used to specify the injection of home interfaces into components that are clients of beans written to the earlier EJB client view.

21.4.4.3 Combined use of EJB 2.x and EJB 3.x persistence APIs

EJB clients may access Java Persistence entities and/or the `EntityManager` together with EJB 2.x entity beans within the same transaction as well as within separate transactions.^[104]

21.4.5 Adapting EJB 3.x Session Beans to Earlier Client Views

Clients written to the EJB 2.1 and earlier client view depend upon the existence of a home and component interface.

A session bean written to the EJB 3.x API may be adapted to such earlier preexisting client view interfaces.

The session bean designates the interfaces to be adapted by using the `RemoteHome` and/or `LocalHome` metadata annotations on the bean class (or equivalent deployment descriptor elements). The corresponding `Remote` and/or `Local` component interfaces are not explicitly specified when using these annotations. Rather, they are derived from the `Home` / `LocalHome` interfaces themselves.

When the client is deployed, the container classes that implement the EJB 2.1 home and remote interfaces (or local home and local interfaces) referenced by the client must provide the implementation of the `javax.ejb.EJBHome` and `javax.ejb.EJBObject` interfaces (or the `javax.ejb.EJBLocalHome` and `javax.ejb.EJBLocalObject` interfaces) respectively.

[104]In general, the same database should not be accessed by both Java Persistence entities and EJB 2.x entities within the same application: behavior is unspecified if data aliasing occurs.

In addition, the container implementation classes must implement the methods of the home and component interfaces to apply to the EJB 3.x component being referenced as described below.

21.4.5.1 Stateless Session Beans

The invocation of the home `create()` method must return the corresponding local or remote component interface of the bean. This may or may not cause the creation of the bean instance, depending on the container's implementation strategy. For example, the container may preallocate bean instances (e.g., in a pooling strategy) or may defer the creation of the bean instance until the first invocation of a business method on the bean class. When the bean instance is created, the container invokes the `setSessionContext` method (if any), performs any other dependency injection, and invokes the `PostConstruct` lifecycle callback method(s), (if any), as specified in Section 4.3.10.

It is likewise implementation-dependent as to whether the invocation of the `EJBHome remove(Handle)` or `EJBObject` or `EJBLocalObject remove()` method causes the immediate removal of the bean instance, depending on the container's implementation strategy. When the bean instance is removed, the `PreDestroy` callback method(s) (if any) are invoked, as specified in Section 4.7.1

The invocations of the business methods of the component interface are delegated to the bean class.

21.4.5.2 Stateful Session Beans

The invocation of the home `create<METHOD>()` method causes construction of the bean instance, invocation of the `PostConstruct` lifecycle callback(s) (if any), and invocation of the matching `Init` method, and returns the corresponding local or remote component interface of the bean. The invocation of these methods occurs in the same transaction and security context as the client's call to the `create` method.

The invocation of the `EJBHome remove(Handle)` or `EJBObject` or `EJBLocalObject remove()` method causes the invocation of the `PreDestroy` lifecycle callback method(s) (if any) and removal of the bean instance, as described in Section 4.3.11.

The invocations of the business methods of the component interface are delegated to the bean class.

The `Init` annotation is used to specify the correspondence of a method on the bean class with a `create` method of the adapted `EJBHome` and/or adapted `EJBLocalHome` interface. The result type of such an `Init` method is required to be `void`, and its parameter types must be exactly the same as those of the referenced `create<METHOD>` method.

Embeddable Usage

This chapter describes the requirements for the execution of EJB applications within a Java SE environment. Unlike traditional Java EE server-based execution, embeddable usage allows client code and its corresponding enterprise beans to run within the same JVM and class loader. This provides better support for testing, offline processing (e.g. batch), and the use of the EJB programming model in desktop applications.

22.1 Overview

Embeddable usage requirements allow client code to instantiate an EJB container that runs within its own JVM and classloader. The client uses a spec-defined bootstrapping API to start the container and identify the set of enterprise bean components for execution.

The embeddable EJB container provides a managed environment with support for the same basic services that exist within a Java EE runtime : injection, access to a component environment, container-managed transactions, etc. In general, enterprise bean components are unaware of the kind of managed environment in which they are running. This allows maximum reusability of enterprise components across a wide range of testing and deployment scenarios without significant rework.

22.2 Bootstrapping API

The embeddable container is instantiated using a bootstrapping API defined within the `javax.ejb` package. By default, the embeddable container uses the JVM class path to scan for the enterprise bean modules to be initialized. The client can override this behavior during setup by specifying an alternative set of target modules.

22.2.1 EJBContainer

The `javax.ejb.embeddable.EJBContainer` abstract class represents an instance of an embeddable container. It contains factory methods for creating a container instance. The client initializes a new embeddable container by calling the `createEJBContainer` method of the `javax.ejb.embeddable.EJBContainer` class.

For example,

```
EJBContainer ec = EJBContainer.createEJBContainer();
```

By default, the embeddable container searches the JVM classpath (the value of the Java System property `java.class.path`) to find the set of EJB modules for initialization. A classpath entry is considered a matching entry if it meets one of the following criteria:

- It is an `ejb-jar` according to the standard module-type identification rules defined by the Java EE platform specification
- It is a directory containing a `META-INF/ejb-jar.xml` file or at least one `.class` with an enterprise bean component-defining annotation

Each matching entry is considered an EJB module within the same application.^[105]

If an `ejb-jar.xml` is present the `module-name` element defines the module name. Otherwise, for `ejb-jars` the module name is the unqualified file name excluding the “`jar`” extension and for directories the module name is the unqualified name of the directory (the last name in the pathname’s name sequence). The embeddable container is not required to support more than one matching entry with the same module name.

An alternative form of the `createEJBContainer` method provides a set of properties for customizing the embeddable container creation :

```
javax.ejb.embeddable.EJBContainer createEJBContainer (Map<?, ?> properties)
```

This specification reserves the prefix “`javax.ejb.`” for standard property names. It is expected that Container Providers will define their own properties as well.

[105] Support for more than one module is required for a Full Java EE platform product. Multi-module support is only required for Java EE profiles that require support for `.ear` files.

For example, given the following `java` command and assuming `foo.jar`/`bar.jar` are both valid `ejb-jars` :

```
java -classpath foo.jar:bar.jar:vendor-rt.jar:client.jar
      com.acme.Client
```

The following will result in only the `bar.jar` module being initialized by the container :

```
Properties props = new Properties();
props.setProperty(EJBContainer.MODULES, "bar");

EJBContainer ec = EJBContainer.createEJBContainer(props);
```

A Container Provider is permitted to require that a preprocessing or tooling step be performed on the application modules prior to JVM initialization.

After identifying the set of matching modules, the embeddable container commences application initialization. Any Singleton components configured for eager initialization will be initialized at this point. When the `createEJBContainer` method returns successfully, the client can access the client view of any enterprise bean in the application.

Enterprise beans running within the embeddable container are loaded using the context class loader active on the thread at the time that `createEJBContainer` is called.

22.2.2 Standard Initialization Properties

The following embeddable container initialization properties are required to be supported by all Container Providers.

22.2.2.1 `javax.ejb.embeddable.provider`

This property holds a String value that specifies the fully-qualified name of an embeddable container provider class corresponding to the embeddable container implementation that should be used for this application.

The property name is defined as `EJBContainer.PROVIDER`.

22.2.2.2 `javax.ejb.embeddable.modules`

This property is used to explicitly specify the module(s) to be initialized. It can refer to modules that are included in the JVM classpath or to modules outside the JVM classpath.

If the target modules are part of the classpath, this property holds either a single module name (`java.lang.String`) or an array of module names (`java.lang.String[]`). For each specified module name, the container searches the class path for the first eligible `ejb-jar` or directory whose corresponding module name matches the given name. All specified modules must match an entry in the classpath.

If the target modules are outside of the classpath, this property holds either a single `java.io.File` object or an array of `java.io.File` objects, where each file object refers to either an `ejb-jar` or an exploded `ejb-jar` directory in the format listed above. Note that in this case it is the responsibility of the caller to ensure that the context class loader has visibility to the classes required by these modules.

The property name is defined as `EJBContainer.MODULES`.

22.2.2.3 `javax.ejb.embeddable.appName`

This property specifies an application name for the EJB modules executing within the embeddable container. If specified, the property value applies to the `<app-name>` portion of the portable global JNDI name syntax. It is recommended that this property be set whenever an embeddable container is executed with more than one `ejb` module.

The property name is defined as `EJBContainer.APP_NAME`.

22.2.3 Looking Up Session Bean References

The `EJBContainer` instance can be used to retrieve a `javax.naming.Context` object that supports lookups of client references to session beans running within the embeddable container. Session bean references are identified using the portable `"java:global/"` JNDI name syntax defined in **Section 4.4**.

A client retrieves a `Context` object using the following `EJBContainer` method:

```
javax.naming.Context EJBContainer.getContext();
```

Here is an example of a lookup for the `FooLocal` local business interface of a session bean with `ejb-name FooBean` in `ejb-jar foo.jar`:

```
Context ctx = ec.getContext();  
FooLocal foo = (FooLocal) ctx.lookup("java:global/foo/FooBean");
```

22.2.4 Embeddable Container Shutdown

The `EJBContainer.close()` method is used to shut down an embeddable container instance and its associated application. The client is not required to call `close()` but its use is recommended for optimal resource cleanup, especially in the case that application lifetime is shorter than the lifetime of the enclosing JVM. During the processing of the `close()` method the embeddable container must call the `PreDestroy` method(s) of any `Singleton` bean instances in the application.

A container provider is only required to support one active embeddable EJB container at a time per JVM. Attempts to concurrently create multiple active mbeddable EJB containers may result in a container initialization error.

22.3 Container Provider's Responsibilities

This section describes the responsibilities of the Container Provider to support an embeddable container environment.

22.3.1 Runtime Environment

The Container Provider is required to support the EJB Lite subset of the EJB 3.1 API within an embeddable container environment. A Container Provider may alternatively choose to support the full EJB API within an embeddable container environment. See Section 21.1 for more details.

22.3.2 Naming Lookups

The Container Provider is required to support naming lookups of the Local and no-interface view of any session beans defined to run within the embeddable container. Naming entries for these enterprise beans must conform to the portable global JNDI name requirements in Section 4.4.

22.3.3 Embeddable Container Bootstrapping

A Container Provider implementation also acts as a service provider by supplying a service provider configuration file as described in the JAR File Specification [33].

The service provider configuration file serves to export the embeddable container implementation class to the `EJBContainer` bootstrap class, positioning itself as a candidate for instantiation.

The Container Provider supplies the provider configuration file by creating a text file named `javax.ejb.spi.EJBContainerProvider` and placing it in the `META-INF/services` directory of one of its JAR files. The contents of the file should be the name of the embeddable container provider implementation class of the `javax.ejb.spi.EJBContainerProvider` interface.

Example:

An embeddable container provider creates a JAR called `acme.jar` that contains its embeddable container implementation. The JAR includes the provider configuration file :

```
acme.jar
META-INF/services/javax.ejb.spi.EJBContainerProvider
com/acme/EJBContainerProvider.class
...
```

The contents of the `META-INF/services/javax.ejb.spi.EJBContainerProvider` file is nothing more than the name of the implementation class : `com.acme.EJBContainerProvider`.

The `EJBContainer` bootstrap class will locate all of the container providers by their provider configuration files and call `EJBContainerProvider.createEJBContainer(Map<?, ?>)` on them in turn until an appropriate backing provider returns an `EJBContainer`. A provider may deem itself as appropriate for the embeddable application if any of the following are true :

- The `javax.ejb.embeddable.provider` property was included in the `Map` passed to `createEJBContainer` and the value of the property is the provider's implementation class.
- No `javax.ejb.embeddable.provider` property was specified.

If a provider does not qualify as the provider for the embeddable application, it must return `null` when `createEJBContainer` is invoked on it.

22.3.4 Concrete `javax.ejb.EJBContainer` Implementation Class

The Container Provider is required to provide a sub-class of the `javax.ejb.embeddable.EJBContainer` class. The following are the requirements for this class :

- The class must be defined as `public` and must not be `abstract`
- The class must extend either directly or indirectly the class `javax.ejb.embeddable.EJBContainer`
- The class must provide implementations of the following `javax.ejb.embeddable.EJBContainer` methods :
 - `getContext()`
 - `close()`

Responsibilities of EJB Roles

This chapter provides the summary of the responsibilities of each EJB Role.

23.1 Bean Provider's Responsibilities

This section highlights the requirements for the Bean Provider. Meeting these requirements is necessary to ensure that the enterprise beans developed by the Bean Provider can be deployed in all compliant EJB containers.

23.1.1 API Requirements

The enterprise beans must meet all the API requirements defined in the individual chapters of this document.

23.1.2 Packaging Requirements

The Bean Provider is responsible for packaging the enterprise beans in an ejb-jar file or .war file in the format described in Chapter 20.

The deployment descriptor, if present, must conform to the requirements of Chapter 19.

23.2 Application Assembler's Responsibilities

The requirements for the Application Assembler are in defined in Chapter 19 and Chapter 20.

23.3 EJB Container Provider's Responsibilities

The EJB Container Provider is responsible for providing the deployment tools used by the Deployer to deploy enterprise beans packaged in the `ejb-jar` file. The requirements for the deployment tools are defined in the individual chapters of this document.

The EJB Container Provider is responsible for implementing its part of the EJB contracts and its part of the contracts described in the document “*Java Persistence API*” of this specification [2], and for providing all the runtime services described in the individual chapters of this document.

23.4 Persistence Provider's Responsibilities

The Persistence Provider is responsible for implementing its part of the contracts described in the document “*Java Persistence API*” of this specification [2].

23.5 Deployer's Responsibilities

The Deployer uses the deployment tools provided by the EJB Container Provider to deploy `ejb-jar` files or `.war` files produced by the Bean Providers and Application Assemblers.

The individual chapters of this document describe the responsibilities of the Deployer in more detail.

23.6 System Administrator's Responsibilities

The System Administrator is responsible for configuring the EJB container and server, setting up security management, integrating resource managers with the EJB container, and runtime monitoring of deployed enterprise beans applications.

The individual chapters of this document describe the responsibilities of the System Administrator in more detail.

23.7 Client Programmer's Responsibilities

The EJB client programmer writes applications that access enterprise beans via their business interfaces, via their no-interface view, via their web service client view, or via messages, or view their home and component interfaces.

Related Documents

- [1] EnterpriseJavaBeans, version 3.1. EJB <http://java.sun.com/products/ejb>.
- [2] Java Persistence API, version 2. <http://jcp.org/en/jsr/detail?id=317>.
- [3] EnterpriseJavaBeans, version 2. (EJB 2.1). <http://java.sun.com/products/ejb>.
- [4] JavaBeans. <http://java.sun.com/beans>.
- [5] Java Naming and Directory Interface (JNDI). <http://java.sun.com/products/jndi>.
- [6] Java Remote Method Invocation (RMI). <http://java.sun.com/products/rmi>.
- [7] Java Security. <http://java.sun.com/security>.
- [8] Java Transaction API (JTA). <http://java.sun.com/products/jta>.
- [9] Java Transaction Service (JTS). <http://java.sun.com/products/jts>.
- [10] Java Language to IDL Mapping Specification. <http://www.omg.org/cgi-bin/doc?ptc/00-01-06>.
- [11] CORBA Object Transaction Service v1.2. <http://www.omg.org/cgi-bin/doc?ptc/2000-11-07>.
- [12] Java Platform, Enterprise Edition (Java EE), v6. <http://jcp.org/en/jsr/detail?id=316>.
- [13] Java Message Service (JMS), v 1.1. <http://java.sun.com/products/jms>.
- [14] Java API for XML Messaging (JAXM).
- [15] Java 2 Enterprise Edition Connector Architecture, v1.6 . <http://jcp.org/en/jsr/detail?id=322>.

- [16] Enterprise JavaBeans to CORBA Mapping v1.1. <http://java.sun.com/products/ejb/docs.html>.
- [17] CORBA 2.3.1 Specification. <http://www.omg.org/cgi-bin/doc?formal/99-10-07>.
- [18] CORBA COSNaming Service. <http://www.omg.org/cgi-bin/doc?formal/00-06-19>.
- [19] Interoperable Name Service FTF document. <http://www.omg.org/cgi-bin/doc?ptc/00-08-07>.
- [20] RFC 2246: The TLS Protocol. <ftp://ftp.isi.edu/in-notes/rfc2246.txt>.
- [21] RFC 2712: Addition of Kerberos Cipher Suites to Transport Layer Security. <ftp://ftp.isi.edu/in-notes/rfc2712.txt>.
- [22] The SSL Protocol Version 3.0. <http://home.netscape.com/eng/ssl3/draft302.txt>.
- [23] Common Secure Interoperability Version 2 Final Available Specification. <http://www.omg.org/cgi-bin/doc?ptc/2001-06-17>.
- [24] Database Language SQL. ANSI X3.135-1992 or ISO/IEC 9075:1992.
- [25] Java API for XML-based RPC (JAX-RPC) 2.0. <http://jcp.org/en/jsr/detail?id=101>.
- [26] Web Services Description Language (WSDL) 1.1. <http://www.w3.org/TR/wsdl>.
- [27] W3C: SOAP 1.1. <http://www.w3.org/TR/SOAP/>.
- [28] The Java Virtual Machine Specification.
- [29] JDBC 3.0 Specification. <http://java.sun.com/products/jdbc>.
- [30] Web Services Metadata for the Java Platform. <http://jcp.org/en/jsr/detail?id=181>.
- [31] Web Services for Java EE, Version 1.2. <http://jcp.org/en/jsr/detail?id=109>.
- [32] Java API for XML Web Services (JAX-WS 2.0). <http://jcp.org/en/jsr/detail?id=224>.
- [33] JAR File Specification, <http://java.sun.com/javase/6/docs/technotes/guides/jar/index.html>.
- [34] Java SE 6 API, <http://java.sun.com/javase/6/docs/api>
- [35] Enterprise JavaBeans, version 3.0. (EJB 3.0). <http://java.sun.com/products/ejb>
- [36] List of zoneinfo time zones : http://en.wikipedia.org/wiki/List_of_tz_zones
- [37] Java Platform, Enterprise Edition (Java EE) Managed Bean Specification. <http://jcp.org/en/jsr/detail?id=316>

Revision History

This appendix lists the significant changes that have been made during the development of the EJB 3.1 Specification.

A.1 Early Draft

Created document from the EJB 3.0 Final Release.

Applied modifications specified by JSR 220 Change Log.

Clarified Session Bean Creation Section 4.3.10 to emphasize the absence of any ordering dependencies between injected `SessionContext` objects and other kinds of injected dependencies.

Added no-interface view.

Removed restriction from Section 12.3 that prohibited `AroundInvoke` methods from being exposed as business methods. This is to achieve a consistent rule allowing any callback method to be exposed as a business method. Added caveats to Section 4.9.8 about exposing callbacks as business methods.

Added Singleton session bean component.

Added Timer Service calendar-based expressions and automatic timers.

Added requirements for packing/deploying enterprise beans directly within a .war.

Added asynchronous session bean invocations.

Added requirements for EJB container support in Java EE subset Profiles.

Clarified PostConstruct/PreDestroy session bean behavior in Section 14.3.3 , Table 19

A.2 Public Draft

Chapter 2 Overview

- Added section describing goals for pruning and pruning candidates

Chapter 3 Session Bean Client View

- Added caveats to no-interface view section regarding assumptions about access to instance state and constructors (3.4.4)
- Clarified requirements for support of intra-application vs. inter-application access to the Local view (3.2.2)

Chapter 4 Session Bean Component Contract

- Added individual annotations for each of the SessionSynchronization methods
- Added requirements for use of `@Asynchronous` on business interfaces
- Added container managed concurrency `AccessTimeout`
- Added container managed transaction (CMT) requirements to Singleton `@PostConstruct/@PreDestroy`
- Added section on portable Global JNDI name syntax
- Removed transacted / persistent semantics requirements from asynchronous session bean methods .
- Removed restriction prohibiting use of session bean class as superclass of session bean class.
- Changed concurrency management annotations to match style of tx management / tx attribute annotations
- Clarified behavior of stateful session bean `getCallerPrincipal/isCallerInRole` callback methods (4.6.1)
- Clarified Singleton eager/lazy initialization requirements (4.8.1)

- Clarified Singleton destruction behavior, including access to dependent singletons during `@PreDestroy` (4.8.2)
- Clarified distinction between required concurrency locking semantics and optional container policies (4.8.4.1)
- Clarified defaulting rules for a bean with only a no-interface view or single local business interface (4.9.7 / 4.9.8)

Chapter 5 Message-Driven Beans

- Added `isCallerInRole` to Operations Allowed method list for message listener methods
- Added section on security context to describe possibility that caller principal flows into message listener methods

Chapter 7 Client View of an EJB 2.1 Entity Bean

Chapter 8 EJB 2.1 Entity Bean Component Contract for CMP

Chapter 9 EJB QL

Chapter 10 Entity Bean Component Contract for BMP

Chapter 11 EJB 1.1 Entity Bean Component Contract for CMP

- All marked as pruning candidates

Chapter 13 Support for Transactions

- Added requirement for timing of return value marshalling with respect to transaction boundaries

Chapter 16 Enterprise Bean Environment

- Added support for `<module-name>/<bean-name>` syntax in `ejb-ref/ejb-local-ref/ejb-link` element and `@EJB beanName()` attribute
- Added support for portable global JNDI name syntax in `ejb-ref/ejb-local-ref/mapped-name` element and `@EJB mappedName()` attribute

Chapter 18 Timer Service

- Added increment `(x/y)` syntax
- Added to day of month syntax to support nth day of week, last day of month, and n days before last day of month
- Added non-persistent timers

- Added optional “info” string for automatic timers specified via `@Schedule`

Chapter 20 Packaging

- Added requirements for packaging of `ejb-jar` in `WEB-INF/lib`
- Added restriction that local/no-interview views of beans packaged in `.war` are only required to be accessible within the `.war`
- Added section detailing EJB annotation processing requirements for `ejb-jars` and `.wars`

Chapter 21 Runtime Environment

- Added section on EJB Lite

Added new Chapter (23) on Embeddable EJB Usage

A.3 Proposed Final Draft

Chapter 1 Introduction

- Added separate Interceptor document to list of Specification Documents

Chapter 3 Session Bean Client View

- Clarified asynchronous `Future.cancel()` behavior

Chapter 4 Session Bean Component Contract

- Clarified behavior of `SessionContext` method (renamed `wasCancelCalled`) corresponding to asynchronous `Future.cancel`.
- Clarified Singleton `PostConstruct/PreDestroy` transactional behavior
- Clarified that `AfterBegin`, `BeforeCompletion`, `AfterCompletion` callback methods can have any method access type.
- Added spec-defined stateful session bean timeout (`@StatefulTimeout`)
- Made serialization of concurrent requests (including the option to use `@AccessTimeout`) the default behavior for Stateful session beans. Added `CONCURRENCY_NOT_ALLOWED` option that results in exception behavior upon concurrent access attempts that matches previous specification.
- Updated Global JNDI section to synchronize with Java EE 6 Specification.
- Clarified that session bean asynchronous methods only apply to no-interface, Local business, and Remote business views.

- Clarified behavior of `javax.ejb.AsyncResult`
- Defined Singleton reentrancy behavior.
- Clarified transactional semantics of Singleton `PostConstruct/PreDestroy`
- Clarified that the EJB 2.x client view is not supported by Singletons
- Added general warning about the use of callback methods as business methods
- Added restriction that bean class and superclass methods of a bean with a no-interface view must not be marked `final`.

Chapter 5 Message-Driven Bean Component Contract

- Made superclass behavior consistent with Session Beans

Chapter 6 Persistence

- Clarified that Java Persistence is now defined in a separate specification.

Chapter 12 Interceptors

- Revised chapter to refer to common requirements in Interceptors document and only list specific requirements w.r.t. the combination of enterprise bean components and interceptors.
- Added `@AroundTimeout` coverage for EJB timers

Chapter 13 Support for Transactions

- Clarified requirements for assigning Singleton `PostConstruct/PreDestroy` transaction attributes.
- Clarified that `Local method-intf` tag includes no-interface view.

Chapter 14 Exception Handling

- Clarified subclassing behavior of unchecked exceptions marked as application exceptions. Added inherited attribute to allow setting of desired subclassing behavior.
- Updated exception handling tables to use consistent terminology w.r.t. transaction rollback.

Chapter 15 Support for Distributed Interoperability

- Clarified that distributed interoperability requirements do not apply to EJB 3.x Remote client view.

Chapter 16 Security Management

- Clarified that `Local method-intf` tag includes no-interface view.

Chapter 18 Timer Service

- Made a number of syntax clarifications for calendar-based time expressions
- Added timezone support for calendar-based timers
- Clarified that the new timer functionality (calendar-based timers and non-persistent timers) is not supported for EJB 2.x entity beans
- Renamed some timer creation methods to resolve compilation ambiguity.
- Extended optional timer parameter support to programmatic timeout callback methods.
- Clarified removal / getNextTimeout / getTimeRemaining behavior for schedule-based timers

Chapter 19 Deployment Descriptor

- Updated schema document

Chapter 20 Packaging

- Added restriction that a .war can contain at most one ejb-jar.xml
- Clarified packaging requirements for enterprise beans in a .war
- Clarified scoping requirements for ejb-names, component environment entries, etc. in a .war.

Chapter 21 Runtime Environment

- Added table showing required contents of EJB 3.1 Lite vs. Full EJB 3.1 API
- Removed sections listing API requirements of EJB containers. This is the responsibility of the profile specifications that include EJB 3.1.
- Added Compatibility and Migration section

Chapter 22 Embeddable Usage

- Added requirement for support of Files in the embeddable modules property.
- Added embeddable app name property for setting the <app-name> portion of the global naming syntax

A.4 Final Release

Chapter 2 Overview

- Added sub-section on relationship of EJB 3.1 specification to Java EE 6 Managed Bean specification.

Chapter 3 Session Bean Client View

- Clarified that it is permissible for a session bean to expose both a webservice view and remote view based on the same interface.
- Clarified exception behavior for access of singletons whose initialization failed.
- Clarified system exception behavior for asynchronous invocations on remote business interfaces that are subtypes of `java.rmi.Remote`
- Clarified concurrency behavior of session bean reference objects

Chapter 4 Session Bean Component Contract

- Added `getContextData` method to `EJBContext`.
- Added requirements for stateful timeout values 0 and -1.
- Added requirements for access timeout values 0 and -1.
- Removed `CONCURRENCY_NOT_ALLOWED` concurrency management type and replaced it with use of specific access timeout value.
- Changed `java:app` portable JNDI name syntax to require `<module-name>` for all module packaging scenarios.
- Removed support for use of `@Asynchronous` on business interfaces.
- Clarified that the prohibition against invoking a stateful session bean that is participating in a transaction only applies to EJB 2.x style remove methods, not EJB 3.x style `@Remote` methods.
- Clarified meaning of “external” client requests in the context of Singleton initialization rules.
- Stated that circular dependencies within `DependsOn` metadata are not required to be detected.
- Fixed client view determination rules for local interface view to reflect EJB 3.0 requirements by not taking web service view into account.

Chapter 17 Security

- Updated annotation requirements to match new JSR 250 requirements that `DenyAll` is allowed at the bean class level.

Chapter 18 Timer Service

- Clarified default timezone rules.

- Clarified rules for specification of timer-method parameters in `ejb-jar.xml`.

Chapter 19 Deployment Descriptor

- Updated deployment descriptor sections with coverage of EJB 3.1 elements.
- Updated `ejb-jar_3_1.xsd` content to match final schema.

Chapter 20 Packaging

- Updated deployment descriptor requirements in `.war` to only support packaging of `ejb-jar.xml` within `WEB-INF`.
- Added restriction that JAX-RPC based EJB endpoints can not be packaged in a `.war`.

Chapter 21 Embeddable Usage

- Improvements to embeddable API names .
- Clarified that only one embeddable EJB container instance is required to be supported at any one time per JVM.